

TEXTON



SOFTSTYLE

SHADES

Effective February 4, 2019

design simplified™

TABLE OF CONTENTS

• What's New for 2019	2
• Features & Benefits	2
• Pattern Information	3
• Color Charts	4-6
• Pricing and Options– Standard Rectangular	7-16
• Motorization Surcharges and Options	17

Rectangular Configuration Specifications

• Standard Cordlock	18
• Two-on-One Rail	18
• Top-Down and Top-Down/Bottom-Up	19
• Cut-Outs	19
• Cordless Lift	20
• Cordless Lift & Lock™	21
• Continuous Cord Loop	22

Versatile Innovations™

TriLight Shades®

• Smart Facts	23
• Selecting a TriLight Shade	23
• Sheer Pleated Color Chart	24
• Pricing and Options	25
• Configuration Specifications	26-28
• RemoteLift™ 2.0 Motorization	29-33
• Simplicity and PowerWand™	34-39
• Vertical Application	40-42
• Classic Skylight and Skylight with Simplicity Motorization	43-46
• Arches	47-48
• Specialty Shapes	49-50
• Size Standards Summary	51-54
• Product Components	55-66

Oversize Common Carrier Delivery

All orders with any quantity of shades or blinds or any continuous valance 96" or more in width (or Vertical Applications over 96" in height) are considered oversize. Therefore, a net shipping charge of \$40 per oversized unit will be assessed.

Oversized orders that require expedited shipping will be quoted and charged accordingly.

Please see General Information for additional freight and shipping charge information.

WHAT'S NEW FOR 2019





- New Simplicity Rechargeable motorization Top-Down/Bottom-Up – provides the flexibility of Top-Down/Bottom-Up with the ease of motorization.
- New Skylight with Simplicity motorization, now available with Rechargeable Battery. Rechargeable motorization offers expanded flexibility in this popular system, pair with a Solar Panel for true simplicity.
- Option of a single handle on Cordless Shades greater than 42" wide. A great option for windows needing the extension pole for access. Standardize the look across different widths.
- Continuous Cordloop Trilight now features the deluxe middle rail. Allows middle rail adjustability and a standard look across Trilight lifting systems.

FEATURES & BENEFITS



- Thick cellular fabric provides superior insulation for reduced heating and cooling bills. It also absorbs sound, making rooms more comfortable.
- Semi-opaque and blackout cellular fabrics are available in multiple sizes, including 2" Hybrid Pleat, providing a choice for every window size and desired light and privacy control.
- The neutral white backing provides a consistent appearance to the outside of the home.
- Shades feature the same reliable 3/4" standard headrail used with Cellular Shades.
- Offered with a wide selection of control options, including top-down/bottom-up, continuous loop, cordless lift, cordless Lift & Lock™, vertical application and motorized control, to fit any need.
- Features Versatile Innovations™ TriLight Shades® for enhanced versatility.
- Limited Lifetime Warranty ensures your customers' satisfaction.

CELLULAR SHADE PATTERN INFORMATION

Pattern Name	# of Cells	Price Group (Standard)	Winter R-Values	Care Code	Light Control	Hardware Restrictions	Hardware Options	
Semi Opaque - Single Cell								
SoftStyle Beginnings Semi-Opaque – Large Single Cell	S50	Single	2-SS	**	1, 2 & 3	C	<ul style="list-style-type: none"> • Standard Cordlock – 3/4" Rail System • Continuous Cord Loop System • Continuous Cord Loop Top-Down/Bottom-Up • Cordless Lift System • Cordless Lift System Top-Down/Bottom-Up • Cordless Lift & Lock • Cordless Lift & Lock Top-Down/Bottom-Up • Top-Down • Top-Down/Bottom-Up • Two-On-One Rail • Vertical Application • Classic Skylight • Arches • Angles • Specialty Shapes • Battery Operated Motorization • TriLight 	
SoftStyle Semi-Opaque – Small Single Cell	S11	Single	1-SS	**	1, 2 & 3	C		Vertical Application
SoftStyle Semi-Opaque – Large Single Cell	S21	Single	4-SS	**	1, 2 & 3	C		
Semi Opaque - Double Cell								
SoftStyle Beginnings Semi-Opaque – Double Cell	S51	Double	3-SS	**	1, 2 & 3	C		Vertical Application
SoftStyle Semi-Opaque – Double Cell	S31	Double	5-SS	**	1, 2 & 3	C		Vertical Application
Blackout - Single Cell								
SoftStyle Blackout – Small Single Cell	S13	Single	6-SS	**	1 & 3	E		Vertical Application
SoftStyle Blackout – Large Single Cell	S23	Single	7-SS	**	1 & 3	E		
SoftStyle Subdue Blackout - Large Single Cell	S61	Single	8-SS	**	1 & 3	E		
Blackout - Double Cell								
SoftStyle Blackout – Double Cell	S32	Double	8-SS	**	1 & 3	E		Vertical Application
Hybrid Pleat								
2" Hybrid Pleat – Semi-Opaque	HPF	Single	Hybrid Pleat Semi-Opaque	4.53	1, 2 & 3	C		Standard Cordlock, Skylight, Arches, Angles, Specialty Shapes, PowerWand
2" Hybrid Pleat – Blackout	HPR	Single	Hybrid Pleat Blackout	4.78	1, 2 & 3	E	Standard Cordlock, Skylight, Arches, Angles, Specialty Shapes, PowerWand	
** Comparable test data on SoftStyle shades is not available.								
<p>Care Method 1 Dusting with a feather, or synthetic, non-abrasive, material duster is recommended for cellular shade surfaces which are lightly soiled.</p>		<p>Care Method 2 Wiping with a soft, damp sponge or cloth, of non-abrasive material, with lukewarm water is recommended for cellular shade surfaces which need spot cleaning.</p>		<p>Care Method 3 Vacuuming with a soft bristle vacuum cleaner brush attachment is recommended for cellular shade surfaces which are heavily soiled.</p>				
<div style="display: flex; justify-content: space-between;"> <div style="width: 22%;">  <p>A. Sheer Softly filters light and reduces glare. Images, shapes and people can be seen clearly. Provides the least amount of light and shape screening.</p> </div> <div style="width: 22%;">  <p>B. Semi-Sheer Filters strong light. Images, shapes and people can be seen with some clarity. Provides a modest degree of light and shape screening.</p> </div> <div style="width: 22%;">  <p>C. Semi-Opaque Significantly reduces light. Images, shapes and people cannot be seen clearly. Provides a moderate to strong degree of light and shape screening. Darker colored materials tend to provide stronger screening than lighter colored materials in this category.</p> </div> <div style="width: 22%;">  <p>D. Opaque Blocks out virtually all light (except light that may enter on the sides of the shade) for maximum privacy and darkness.</p> </div> </div>								

CELLULAR COLOR CHART

FABRIC			HARDWARE	
Code	Color #	Color Name	STD	VA
SMALL SINGLE CELL - Semi-Opaque (Price Group 1-SS)				
S11	589	Afternoon Light	127	N/A
S11	1553	Birdbath	810	
S11	522	Cake Batter	320	
S11	1556	Caribbean Sky	135	
S11	515	Cavern	361	
S11	510	Celadon	958	
S11	581	Coastal Eddy	018	
S11	528	Daisy White	320	
S11	1558	Dark Raisin	849	
S11	1554	Desert Sun	954	
S11	523	Dill	958	
S11	1567	Espresso Bean	849	
S11	1562	Evening Horizon	450	
S11	1559	Fly Fishing	849	
S11	1563	Four Leaf Clover	958	
S11	524	Gold Treasure	952	
S11	513	Graystone	810	
S11	1565	Ground Cloves	960	
S11	1552	Gunnysack	862	
S11	526	Ice Age	862	
S11	1550	Ice Rink	885	
S11	1560	Lava Rock	405	
S11	529	Lemon Frost	882	
S11	500	Marshmallow	661	
S11	507	Mountain Top	320	
S11	525	Mustard Seed	630	
S11	1557	Night Blue	450	
S11	1566	Oak Branch	849	
S11	584	Ocean Blue	450	
S11	527	Pale White *	785	
S11	520	Pure Honey	952	
S11	1564	Redwood	956	
S11	1561	Rock Garden	765	
S11	588	Rocking Chair	083	
S11	517	Rye	630	
S11	503	Scone	320	
S11	509	Silver Dollar	405	
S11	582	Steel	018	
S11	1555	Summer Storm	765	
S11	1551	Sweet Butter	674	
S11	521	Trail	810	
S11	501	Veil	320	

FABRIC			HARDWARE	
Code	Color #	Color Name	STD	VA
LARGE SINGLE CELL - Semi-Opaque (Price Group 4-SS)				
S21	589	Afternoon Light	127	862
S21	1553	Birdbath	810	810
S21	522	Cake Batter	320	862
S21	1556	Caribbean Sky	135	661
S21	515	Cavern	361	862
S21	510	Celadon	958	862
S21	581	Coastal Eddy	018	276
S21	528	Daisy White	320	785
S21	1558	Dark Raisin	849	661
S21	1554	Desert Sun	954	083
S21	523	Dill	958	841
S21	1567	Espresso Bean	849	810
S21	1562	Evening Horizon	450	276
S21	1559	Fly Fishing	849	810
S21	1563	Four Leaf Clover	958	785
S21	524	Gold Treasure	952	082
S21	513	Graystone	810	810
S21	1565	Ground Cloves	960	785
S21	1552	Gunnysack	862	862
S21	526	Ice Age	862	862
S21	1550	Ice Rink	885	661
S21	1560	Lava Rock	405	276
S21	529	Lemon Frost	882	882
S21	500	Marshmallow	661	661
S21	507	Mountain Top	320	862
S21	525	Mustard Seed	630	082
S21	1557	Night Blue	450	661
S21	1566	Oak Branch	849	810
S21	584	Ocean Blue	450	661
S21	527	Pale White *	785	785
S21	520	Pure Honey	952	082
S21	1564	Redwood	956	083
S21	1561	Rock Garden	765	276
S21	588	Rocking Chair	083	083
S21	517	Rye	630	841
S21	503	Scone	320	862
S21	509	Silver Dollar	405	276
S21	582	Steel	018	276
S21	1555	Summer Storm	765	276
S21	1551	Sweet Butter	674	661
S21	521	Trail	810	810
S21	501	Veil	320	862

FABRIC			HARDWARE	
Code	Color #	Color Name	STD	VA
DOUBLE CELL - Semi-Opaque (Price Group 5-SS)				
S31	589	Afternoon Light	127	N/A
S31	1553	Birdbath	810	
S31	522	Cake Batter	320	
S31	1556	Caribbean Sky	135	
S31	515	Cavern	361	
S31	510	Celadon	958	
S31	581	Coastal Eddy	018	
S31	528	Daisy White	320	
S31	1558	Dark Raisin	849	
S31	1554	Desert Sun	954	
S31	523	Dill	958	
S31	1567	Espresso Bean	849	
S31	1562	Evening Horizon	450	
S31	1559	Fly Fishing	849	
S31	1563	Four Leaf Clover	958	
S31	524	Gold Treasure	952	
S31	513	Graystone	810	
S31	1565	Ground Cloves	960	
S31	1552	Gunnysack	862	
S31	526	Ice Age	862	
S31	1550	Ice Rink	885	
S31	1560	Lava Rock	405	
S31	529	Lemon Frost	882	
S31	500	Marshmallow	661	
S31	507	Mountain Top	320	
S31	525	Mustard Seed	630	
S31	1557	Night Blue	450	
S31	1566	Oak Branch	849	
S31	584	Ocean Blue	450	
S31	527	Pale White *	785	
S31	520	Pure Honey	952	
S31	1564	Redwood	956	
S31	1561	Rock Garden	765	
S31	588	Rocking Chair	083	
S31	517	Rye	630	
S31	503	Scone	320	
S31	509	Silver Dollar	405	
S31	582	Steel	018	
S31	1555	Summer Storm	765	
S31	1551	Sweet Butter	674	
S31	521	Trail	810	
S31	501	Veil	320	

NOTE: Pale White (color 527) has a yellow hue. Please review the color carefully during the selection process.

CODE KEY:
 STD = Standard cordlock (Cordless, Cordless Lift & Lock, Continuous Cord Loop, Simplicity and RemoteLift with coordinated rails)
 VA = Vertical application shades

CELLULAR COLOR CHART

FABRIC			HARDWARE	
Code	Color #	Color Name	STD	VA
SMALL SINGLE CELL - Blackout (Price Group 6-SS)				
S13	1743	Birdbath	810	N/A
S13	760	Blue	685	
S13	762	Blush	127	
S13	709	Buttercream	320	
S13	781	Coastal Eddy	018	
S13	703	Crème Brulee	882	
S13	1741	Dried Oregano	621	
S13	1747	Espresso Bean	849	
S13	706	Goose Down	661	
S13	1748	Gray Gust	018	
S13	1744	Ground Pepper	765	
S13	710	Ice Princess	885	
S13	702	Irish Coffee	862	
S13	711	Moon Dust	320	
S13	1750	Night Blue	450	
S13	1784	Ocean Blue	450	
S13	700	Pebble	361	
S13	701	Pitch Black	048	
S13	707	Pristine Palace	785	
S13	1745	Red Sand	956	
S13	704	Richwood	849	
S13	708	Sand Sculpture	882	
S13	1746	Sandstone Gray	810	
S13	763	Silver Dollar	405	
S13	705	Stone Path	630	
S13	1749	Streetlight	450	
S13	740	Thunder Cloud	405	
S13	1742	Yucca Cactus	135	

FABRIC			HARDWARE	
Code	Color #	Color Name	STD	VA
LARGE SINGLE CELL - Blackout (Price Group 7-SS)				
S23	1743	Birdbath	810	810
S23	760	Blue	685	661
S23	762	Blush	127	862
S23	709	Buttercream	320	862
S23	781	Coastal Eddy	018	276
S23	703	Crème Brulee	882	882
S23	1741	Dried Oregano	621	785
S23	1747	Espresso Bean	849	862
S23	706	Goose Down	661	661
S23	1748	Gray Gust	018	276
S23	1744	Ground Pepper	765	276
S23	710	Ice Princess	885	785
S23	702	Irish Coffee	862	862
S23	711	Moon Dust	320	785
S23	1750	Night Blue	450	661
S23	1784	Ocean Blue	450	661
S23	700	Pebble	361	810
S23	701	Pitch Black	048	048
S23	707	Pristine Palace	785	785
S23	1745	Red Sand	956	083
S23	704	Richwood	849	810
S23	708	Sand Sculpture	882	882
S23	1746	Sandstone Gray	810	810
S23	763	Silver Dollar	405	276
S23	705	Stone Path	630	841
S23	1749	Streetlight	450	661
S23	740	Thunder Cloud	405	276
S23	1742	Yucca Cactus	135	785

FABRIC			HARDWARE	
Code	Color #	Color Name	STD	VA
DOUBLE CELL - Blackout (Price Group 8-SS)				
S32	1743	Birdbath	810	N/A
S32	760	Blue	685	
S32	762	Blush	127	
S32	709	Buttercream	320	
S32	781	Coastal Eddy	018	
S32	703	Crème Brulee	882	
S32	1741	Dried Oregano	621	
S32	1747	Espresso Bean	849	
S32	706	Goose Down	661	
S32	1748	Gray Gust	018	
S32	1744	Ground Pepper	765	
S32	710	Ice Princess	885	
S32	702	Irish Coffee	862	
S32	711	Moon Dust	320	
S32	1750	Night Blue	450	
S32	1784	Ocean Blue	450	
S32	700	Pebble	361	
S32	701	Pitch Black	048	
S32	707	Pristine Palace	785	
S32	1745	Red Sand	956	
S32	704	Richwood	849	
S32	708	Sand Sculpture	882	
S32	1746	Sandstone Gray	810	
S32	763	Silver Dollar	405	
S32	705	Stone Path	630	
S32	1749	Streetlight	450	
S32	740	Thunder Cloud	405	
S32	1742	Yucca Cactus	135	

CODE KEY:
 STD = Standard cordlock (Cordless, Cordless Lift & Lock, Continuous Cord Loop, Simplicity and RemoteLift with coordinated rails)
 VA = Vertical application shades

Hardware Colors				
		STD	VA	
018	Satin Silver	X	N/A	
048	Black	X	X	
082	Camel	N/A	X	
083	Cocoa	X	X	
127	Cameo	X	N/A	
135	Whisper Heather	X	N/A	
276	Silverado	N/A	X	
320	Rich Cream	X	N/A	
361	Tender Taupe	X	N/A	
405	Gray Flannel	X	N/A	
450	Skyline	X	N/A	
621	Putty	X	N/A	
630	Gold Leaf	X	N/A	
661	White Tiara	X	X	
674	Bamboo Stalk	X	N/A	
685	Blue Sky	X	N/A	
765	Silver Maple	X	N/A	
785	Aspen White	X	X	
810	Mushroom	X	X	
841	Dark Blonde	N/A	X	
849	Mocha	X	N/A	
862	Gardenia White	X	X	
882	Honey Bisque	X	X	
885	Flex White	X	N/A	
952	Pristine Beach	X	N/A	
954	Tranquil Tea	X	N/A	
956	Renaissance Clay	X	N/A	
958	Velvet Fern	X	N/A	
960	Terra Cotta Um	X	N/A	

CELLULAR COLOR CHART

FABRIC			HARDWARE	
Code	Color #	Color Name	OPTION	VA
2" HYBRID PLEAT - Semi-Opaque				
<i>Where applicable, coordinates with cellular color of the same name</i>				
HPF	2753	Caribbean Sky	135	661
HPF	715	Cavern	361	862
HPF	2750	Coastal Eddy	018	276
HPF	739	Earth	810	810
HPF	2755	Gold Treasure	952	082
HPF	2752	Lava Rock	405	276
HPF	700	Marshmallow	661	661
HPF	2754	Ocean Blue	450	661
HPF	727	Pale White *	785	785
HPF	741	Sandrift	810	810
HPF	2751	Summer Storm	405	276
HPF	735	Whitecap	862	862

NOTE: Pale White (color 727) has a yellow hue. Please review the color carefully during the selection process.

FABRIC			HARDWARE	
Code	Color #	Color Name	OPTION	VA
2" HYBRID PLEAT - Blackout				
<i>Where applicable, coordinates with cellular color of the same name</i>				
HPR	2950	Birdbath	810	810
HPR	2952	Coastal Eddy	018	276
HPR	2951	Gray Gust	018	276
HPR	910	Ice Princess	885	785
HPR	919	Sand Storm	810	810
HPR	917	Whisper	785	785

FABRIC			HARDWARE	
Code	Color #	Color Name	STD	VA
LARGE SINGLE CELL - Semi-Opaque (Price Group 2-SS)				
S50	537	Boulder	765	276
S50	530	Ecru	882	882
S50	540	Lunar	450	661
S50	531	Merino	661	661
S50	534	Teak	630	841
S50	532	Wafer	810	810

FABRIC			HARDWARE	
Code	Color #	Color Name	STD	VA
DOUBLE CELL - Semi-Opaque (Price Group 3-SS)				
S51	537	Boulder	765	N/A
S51	530	Ecru	882	
S51	540	Lunar	450	
S51	531	Merino	661	
S51	534	Teak	630	
S51	532	Wafer	810	

FABRIC			HARDWARE	
Code	Color #	Color Name	STD	VA
LARGE SINGLE CELL - Blackout (Price Group 8-SS)				
S61	3744	Birdbath	810	810
S61	3741	Goose Down	885	661
S61	3745	Gray Gust	018	276
S61	3742	Ice Princess	885	661
S61	3747	Ocean Blue	450	661
S61	3743	Pristine Palace	862	862
S61	3746	Silver Dollar	405	276

CODE KEY:

STD = Standard cordlock (Cordless, Cordless Lift & Lock, Continuous Cord Loop, Simplicity and RemoteLift with coordinated rails)

VA = Vertical application shades

Note: 2" Hybrid Pleat shades are not available with standard cordlock or PowerWand.

GROUP 1-SS (Standard Rectangular)

• SOFTSTYLE 9/16" SEMI-OPAQUE (S11)

WIDTH TO:	24"	30"	36"	42"	48"	54"	60"	66"	72"	84"	96"	108"	120"
HEIGHT TO:													
36"	\$93	106	121	134	148	162	175	187	203	231	260	290	319
42"	101	113	130	148	162	175	192	208	222	254	287	320	354
48"	108	125	140	158	175	192	209	227	244	278	315	350	389
54"	112	131	150	170	187	207	226	246	264	303	342	382	423
60"	121	139	162	181	201	222	240	263	285	328	370	414	455
66"	130	148	171	193	214	237	259	281	305	350	398	443	490
72"	134	156	181	205	230	251	276	301	323	374	425	473	525
78"	140	165	190	213	243	268	294	318	345	398	450	505	558
84"	147	172	200	227	253	278	307	334	361	416	474	529	589
90"	152	180	209	237	268	296	323	353	382	443	502	561	622
96"	158	186	218	249	278	308	340	370	400	463	526	589	653
108"	172	204	236	270	306	336	370	405	440	509	576	645	716
120"	184	219	258	294	332	368	404	442	477	551	629	705	773

CONTINUOUS CORD LOOP SYSTEM "REQUIRED" FOR SIZES TO THE RIGHT OF THE THICK BLACK LINE.

OPTIONS: NO EXTRA CHARGE

- Color-Coordinated Rails
- Cordless Lift & Lock
- Cordless Lift & Lock Two-On-One Headrail – price as 2 separate shades and add together
- Cordless Lift & Lock Three-On-One Headrail – price as 3 separate shades and add together
- Control Positions – left or right side of the shade (Exception: for Two-on-One Headrail, cords must be on opposite ends of the headrail)
- 3" Extension Bracket and 1/2" Spacer Blocks – maximum of 3 spacer blocks per bracket
- Hold Down Brackets
- Cut-Outs – up to 3" wide (see page 19 for details)
- Special Cord Lengths – standard cord is 40% of the height of the shade unless otherwise specified
- Hardware Color Override

OPTIONS: EXTRA CHARGE

- See "SIZE STANDARDS" for complete option details.
- Fabric-Wrapped Rail Optionadd \$23
 - Top-Down & Top-Down/Bottom-Upadd \$80
 - Continuous Cord Loop*add \$57
 - Top-Down/Bottom-Up*add \$137
 - Cordless Lift System*add \$80
 - Two-On-One Headrail* price as 2 separate shades and add \$160 (not available in Top-Down/Bottom-Up)
 - Three-On-One Headrail* price as 3 separate shades and add \$239 (not available in Top-Down/Bottom-Up)
 - Top-Down/Bottom-Up*add \$160
 - Cordless Lift & Lock
 - Top-Down/Bottom-Up*add \$80
 - Premium Headrail Upgrade*add \$15 (Premium Headrail not available with Top-Down/Bottom-Up or TriLight)
 - Cordless Extension Pole #40-0036-000\$39
 - Rectangular Shade and Arch – price as 2 separate shades; One Arch and One Rectangular
 - TriLight Shades – see pages 23-28
 - Angle Cutadd \$128

*NOTE: FABRIC-WRAPPED RAILS ARE OPTIONAL FOR A SURCHARGE ON CONTINUOUS CORD LOOP, CORDLESS LIFT, CORDLESS LIFT & LOCK, AND MOTORIZED SHADES. COLOR-COORDINATED RAILS ARE AVAILABLE AT NO ADDITIONAL CHARGE.

See page 17 for motorization surcharges

GROUP 2-SS (Standard Rectangular)

• SOFTSTYLE 3/4" BEGINNINGS SEMI-OPAQUE (S50)

WIDTH TO:	24"	30"	36"	42"	48"	54"	60"	66"	72"	84"	96"	108"	120"
HEIGHT TO:													
36"	\$104	117	133	147	164	175	190	207	221	252	285	315	347
42"	111	127	144	164	180	195	213	231	248	282	318	353	390
48"	117	137	155	174	193	210	230	248	268	306	345	384	424
54"	123	143	165	185	207	225	247	266	288	328	372	414	460
60"	134	154	177	197	222	244	265	290	312	359	404	452	499
66"	142	166	189	214	239	264	289	313	338	390	440	490	542
72"	150	172	197	225	253	277	303	331	359	411	467	521	574
78"	159	185	214	244	273	299	329	359	390	446	506	565	626
84"	166	194	225	257	289	318	350	380	411	473	537	601	666
90"	173	205	238	272	306	336	369	402	437	503	569	637	706
96"	181	214	248	284	320	352	389	423	459	529	603	672	744
108"	194	231	272	310	350	386	423	464	502	579	655	736	815
120"	214	253	297	340	385	426	468	512	554	641	727	815	903

CONTINUOUS CORD LOOP SYSTEM "REQUIRED" FOR SIZES TO THE RIGHT OF THE THICK BLACK LINE.

OPTIONS: NO EXTRA CHARGE	
<ul style="list-style-type: none"> • Color-Coordinated Rails • Cordless Lift & Lock • Cordless Lift & Lock Two-On-One Headrail – price as 2 separate shades and add together • Cordless Lift & Lock Three-On-One Headrail – price as 3 separate shades and add together 	<ul style="list-style-type: none"> • Control Positions – left or right side of the shade (Exception: for Two-on-One Headrail, cords must be on opposite ends of the headrail) • 3" Extension Bracket and 1/2" Spacer Blocks – maximum of 3 spacer blocks per bracket • Hold Down Brackets • Cut-Outs – up to 3" wide (see page 19 for details) • Special Cord Lengths – standard cord is 40% of the height of the shade unless otherwise specified • Hardware Color Override

OPTIONS: EXTRA CHARGE	
<p>See "SIZE STANDARDS" for complete option details.</p> <ul style="list-style-type: none"> • Fabric-Wrapped Rail Optionadd \$23 • Top-Down & Top-Down/Bottom-Upadd \$80 • Continuous Cord Loop*add \$57 <ul style="list-style-type: none"> – Top-Down/Bottom-Up*add \$137 • Cordless Lift System*add \$80 <ul style="list-style-type: none"> – Two-On-One Headrail* price as 2 separate shades and add \$160 (not available in Top-Down/Bottom-Up) – Three-On-One Headrail* price as 3 separate shades and add \$239 (not available in Top-Down/Bottom-Up) – Top-Down/Bottom-Up*add \$160 	<ul style="list-style-type: none"> • Cordless Lift & Lock <ul style="list-style-type: none"> – Top-Down/Bottom-Up*add \$80 – Premium Headrail Upgrade*add \$15 (Premium Headrail not available with Top-Down/Bottom-Up or TriLight) • Cordless Extension Pole #40-0036-000\$39 • Rectangular Shade and Arch – price as 2 separate shades; One Arch and One Rectangular • TriLight Shades – see pages 23-28 • Angle Cutadd \$128

*NOTE: FABRIC-WRAPPED RAILS ARE OPTIONAL FOR A SURCHARGE ON CONTINUOUS CORD LOOP, CORDLESS LIFT, CORDLESS LIFT & LOCK, AND MOTORIZED SHADES. COLOR-COORDINATED RAILS ARE AVAILABLE AT NO ADDITIONAL CHARGE.

See page 17 for motorization surcharges

GROUP 3-SS (Standard Rectangular)

• SOFTSTYLE BEGINNINGS DOUBLE CELL SEMI-OPAQUE (S51)

WIDTH TO:	24"	30"	36"	42"	48"	54"	60"	66"	72"	84"	96"	108"	120"
HEIGHT TO:													
36"	\$99	109	126	141	156	167	183	196	210	240	271	299	331
42"	106	122	137	156	170	187	202	219	236	269	303	336	372
48"	111	130	149	166	185	201	219	236	256	291	329	366	403
54"	119	135	156	175	196	216	235	254	273	314	355	395	439
60"	128	147	169	190	212	233	254	277	298	342	385	431	476
66"	134	158	181	203	228	251	275	298	323	371	421	467	517
72"	143	165	190	216	242	265	290	316	342	393	446	497	549
78"	151	175	204	232	260	287	315	342	371	425	484	540	597
84"	158	186	216	246	275	303	333	362	393	450	512	573	635
90"	166	194	227	259	291	321	352	384	417	481	544	607	674
96"	172	203	236	270	306	336	370	402	439	506	574	641	710
108"	186	219	259	294	333	368	402	442	479	552	626	701	777
120"	203	242	284	324	366	406	447	488	529	610	693	777	862

CONTINUOUS CORD LOOP SYSTEM "REQUIRED" FOR SIZES TO THE RIGHT OF THE THICK BLACK LINE.

OPTIONS: NO EXTRA CHARGE	
<ul style="list-style-type: none"> • Color-Coordinated Rails • Cordless Lift & Lock • Cordless Lift & Lock Two-On-One Headrail – price as 2 separate shades and add together • Cordless Lift & Lock Three-On-One Headrail – price as 3 separate shades and add together 	<ul style="list-style-type: none"> • Control Positions – left or right side of the shade (Exception: for Two-on-One Headrail, cords must be on opposite ends of the headrail) • 3" Extension Bracket and 1/2" Spacer Blocks – maximum of 3 spacer blocks per bracket • Hold Down Brackets • Cut-Outs – up to 3" wide (see page 19 for details) • Special Cord Lengths – standard cord is 40% of the height of the shade unless otherwise specified • Hardware Color Override

OPTIONS: EXTRA CHARGE	
<p>See "SIZE STANDARDS" for complete option details.</p> <ul style="list-style-type: none"> • Fabric-Wrapped Rail Optionadd \$23 • Top-Down & Top-Down/Bottom-Upadd \$80 • Continuous Cord Loop*add \$57 <ul style="list-style-type: none"> – Top-Down/Bottom-Up*add \$137 • Cordless Lift System*add \$80 <ul style="list-style-type: none"> – Two-On-One Headrail* price as 2 separate shades and add \$160 (not available in Top-Down/Bottom-Up) – Three-On-One Headrail* price as 3 separate shades and add \$239 (not available in Top-Down/Bottom-Up) – Top-Down/Bottom-Up*add \$160 	<ul style="list-style-type: none"> • Cordless Lift & Lock <ul style="list-style-type: none"> – Top-Down/Bottom-Up*add \$80 – Premium Headrail Upgrade*add \$15 (Premium Headrail not available with Top-Down/Bottom-Up or TriLight) • Cordless Extension Pole #40-0036-000\$39 • Rectangular Shade and Arch – price as 2 separate shades; One Arch and One Rectangular • TriLight Shades – see pages 23-28 • Angle Cutadd \$128

*NOTE: FABRIC-WRAPPED RAILS ARE OPTIONAL FOR A SURCHARGE ON CONTINUOUS CORD LOOP, CORDLESS LIFT, CORDLESS LIFT & LOCK, AND MOTORIZED SHADES. COLOR-COORDINATED RAILS ARE AVAILABLE AT NO ADDITIONAL CHARGE.

See page 17 for motorization surcharges

GROUP 4-SS (Standard Rectangular)

• SOFTSTYLE 3/4" SEMI-OPAQUE (S21)

WIDTH TO:	24"	30"	36"	42"	48"	54"	60"	66"	72"	84"	96"	108"	120"
HEIGHT TO:													
36"	\$120	134	153	169	188	202	218	238	254	290	328	362	399
42"	128	146	166	188	207	225	245	266	285	324	365	405	448
48"	134	158	179	201	223	242	265	285	308	352	397	442	488
54"	142	164	190	212	238	258	284	306	331	377	427	476	529
60"	154	177	204	227	255	280	305	333	359	413	465	520	573
66"	163	191	217	247	275	303	332	360	389	448	506	564	623
72"	172	198	227	258	291	319	349	380	413	473	538	599	660
78"	183	212	247	280	314	344	378	413	448	513	582	650	719
84"	191	224	258	296	332	365	402	437	473	544	617	691	765
90"	200	235	274	313	352	386	424	462	502	579	654	733	812
96"	208	247	285	327	369	404	447	486	528	609	693	773	856
108"	224	266	313	356	402	444	486	533	578	666	754	846	937
120"	247	291	341	392	443	490	539	589	637	737	836	937	1038

CONTINUOUS CORD LOOP SYSTEM "REQUIRED" FOR SIZES TO THE RIGHT OF THE THICK BLACK LINE.

OPTIONS: NO EXTRA CHARGE	
<ul style="list-style-type: none"> • Color-Coordinated Rails • Cordless Lift & Lock • Cordless Lift & Lock Two-On-One Headrail – price as 2 separate shades and add together • Cordless Lift & Lock Three-On-One Headrail – price as 3 separate shades and add together 	<ul style="list-style-type: none"> • Control Positions – left or right side of the shade (Exception: for Two-on-One Headrail, cords must be on opposite ends of the headrail) • 3" Extension Bracket and 1/2" Spacer Blocks – maximum of 3 spacer blocks per bracket • Hold Down Brackets • Cut-Outs – up to 3" wide (see page 19 for details) • Special Cord Lengths – standard cord is 40% of the height of the shade unless otherwise specified • Hardware Color Override

OPTIONS: EXTRA CHARGE	
<p>See "SIZE STANDARDS" for complete option details.</p> <ul style="list-style-type: none"> • Fabric-Wrapped Rail Optionadd \$23 • Top-Down & Top-Down/Bottom-Upadd \$80 • Continuous Cord Loop*add \$57 <ul style="list-style-type: none"> – Top-Down/Bottom-Up*add \$137 • Cordless Lift System*add \$80 <ul style="list-style-type: none"> – Two-On-One Headrail* price as 2 separate shades and add \$160 (not available in Top-Down/Bottom-Up) – Three-On-One Headrail* price as 3 separate shades and add \$239 (not available in Top-Down/Bottom-Up) – Top-Down/Bottom-Up*add \$160 	<ul style="list-style-type: none"> • Cordless Lift & Lock <ul style="list-style-type: none"> – Top-Down/Bottom-Up*add \$80 – Premium Headrail Upgrade*add \$15 (Premium Headrail not available with Top-Down/Bottom-Up or TriLight) • Cordless Extension Pole #40-0036-000\$39 • Rectangular Shade and Arch – price as 2 separate shades; One Arch and One Rectangular • TriLight Shades – see pages 23-28 • Angle Cutadd \$128

*NOTE: FABRIC-WRAPPED RAILS ARE OPTIONAL FOR A SURCHARGE ON CONTINUOUS CORD LOOP, CORDLESS LIFT, CORDLESS LIFT & LOCK, AND MOTORIZED SHADES. COLOR-COORDINATED RAILS ARE AVAILABLE AT NO ADDITIONAL CHARGE.

See page 17 for motorization surcharges

GROUP 5-SS (Standard Rectangular)

• SOFTSTYLE DOUBLE CELL SEMI-OPAQUE (S31)

WIDTH TO:	24"	30"	36"	42"	48"	54"	60"	66"	72"	84"	96"	108"	120"
HEIGHT TO:													
36"	\$126	140	161	180	200	214	233	251	268	307	347	383	423
42"	135	155	174	200	217	239	257	280	302	343	387	429	475
48"	143	167	191	212	235	256	280	302	328	372	420	468	516
54"	151	172	201	225	251	276	300	324	349	401	454	505	561
60"	163	188	216	243	271	298	324	354	380	437	492	549	607
66"	171	202	231	258	291	321	352	381	413	474	538	596	660
72"	183	210	243	276	308	338	371	403	437	501	570	635	701
78"	193	225	260	297	333	365	402	437	474	544	618	690	763
84"	202	238	276	314	352	387	425	462	501	576	654	733	812
90"	211	249	290	331	372	411	449	491	532	614	694	775	861
96"	219	258	302	345	390	428	473	515	561	646	734	819	907
108"	238	280	331	376	425	469	515	565	612	706	799	896	992
120"	258	308	362	414	468	520	571	625	676	780	885	992	1101

CONTINUOUS CORD LOOP SYSTEM "REQUIRED" FOR SIZES TO THE RIGHT OF THE THICK BLACK LINE.

OPTIONS: NO EXTRA CHARGE	
<ul style="list-style-type: none"> • Color-Coordinated Rails • Cordless Lift & Lock • Cordless Lift & Lock Two-On-One Headrail – price as 2 separate shades and add together • Cordless Lift & Lock Three-On-One Headrail – price as 3 separate shades and add together 	<ul style="list-style-type: none"> • Control Positions – left or right side of the shade (Exception: for Two-on-One Headrail, cords must be on opposite ends of the headrail) • 3" Extension Bracket and 1/2" Spacer Blocks – maximum of 3 spacer blocks per bracket • Hold Down Brackets • Cut-Outs – up to 3" wide (see page 19 for details) • Special Cord Lengths – standard cord is 40% of the height of the shade unless otherwise specified • Hardware Color Override

OPTIONS: EXTRA CHARGE	
<p>See "SIZE STANDARDS" for complete option details.</p> <ul style="list-style-type: none"> • Fabric-Wrapped Rail Optionadd \$23 • Top-Down & Top-Down/Bottom-Upadd \$80 • Continuous Cord Loop*add \$57 <ul style="list-style-type: none"> – Top-Down/Bottom-Up*add \$137 • Cordless Lift System*add \$80 <ul style="list-style-type: none"> – Two-On-One Headrail* price as 2 separate shades and add \$160 (not available in Top-Down/Bottom-Up) – Three-On-One Headrail* price as 3 separate shades and add \$239 (not available in Top-Down/Bottom-Up) – Top-Down/Bottom-Up*add \$160 	<ul style="list-style-type: none"> • Cordless Lift & Lock <ul style="list-style-type: none"> – Top-Down/Bottom-Up*add \$80 – Premium Headrail Upgrade*add \$15 (Premium Headrail not available with Top-Down/Bottom-Up or TriLight) • Cordless Extension Pole #40-0036-000\$39 • Rectangular Shade and Arch – price as 2 separate shades; One Arch and One Rectangular • TriLight Shades – see pages 23-28 • Angle Cutadd \$128

*NOTE: FABRIC-WRAPPED RAILS ARE OPTIONAL FOR A SURCHARGE ON CONTINUOUS CORD LOOP, CORDLESS LIFT, CORDLESS LIFT & LOCK, AND MOTORIZED SHADES. COLOR-COORDINATED RAILS ARE AVAILABLE AT NO ADDITIONAL CHARGE.

See page 17 for motorization surcharges

GROUP 6-SS (Standard Rectangular)

• SOFTSTYLE 9/16" BLACKOUT (S13)

WIDTH TO:	24"	30"	36"	42"	48"	54"	60"	66"	72"	84"	96"	108"	120"
HEIGHT TO:													
36"	\$126	140	159	175	194	212	230	249	268	305	344	382	423
42"	134	151	172	193	212	235	252	274	296	340	382	425	471
48"	147	167	191	213	236	260	282	308	332	380	432	481	534
54"	156	176	204	231	257	281	307	334	361	416	470	526	583
60"	170	188	218	249	274	303	330	361	390	449	509	569	629
66"	176	201	231	263	295	323	353	387	418	481	548	614	680
72"	188	214	250	284	317	350	382	420	452	524	596	666	740
78"	198	227	263	299	336	372	407	446	481	557	635	710	789
84"	207	237	277	317	354	392	429	471	509	591	671	752	835
90"	218	251	296	335	377	419	459	503	546	632	718	807	896
96"	227	263	308	351	397	440	481	528	573	664	758	851	945
108"	245	286	336	385	436	484	529	583	630	731	834	937	1043
120"	263	310	365	418	486	525	580	636	689	799	911	1026	1136

CONTINUOUS CORD LOOP SYSTEM "REQUIRED" FOR SIZES TO THE RIGHT OF THE THICK BLACK LINE.

OPTIONS: NO EXTRA CHARGE	
<ul style="list-style-type: none"> • Color-Coordinated Rails • Cordless Lift & Lock • Cordless Lift & Lock Two-On-One Headrail – price as 2 separate shades and add together • Cordless Lift & Lock Three-On-One Headrail – price as 3 separate shades and add together 	<ul style="list-style-type: none"> • Control Positions – left or right side of the shade (Exception: for Two-on-One Headrail, cords must be on opposite ends of the headrail) • 3" Extension Bracket and 1/2" Spacer Blocks – maximum of 3 spacer blocks per bracket • Hold Down Brackets • Cut-Outs – up to 3" wide (see page 19 for details) • Special Cord Lengths – standard cord is 40% of the height of the shade unless otherwise specified • Hardware Color Override

OPTIONS: EXTRA CHARGE	
<p>See "SIZE STANDARDS" for complete option details.</p> <ul style="list-style-type: none"> • Fabric-Wrapped Rail Optionadd \$23 • Top-Down & Top-Down/Bottom-Upadd \$80 • Continuous Cord Loop*add \$57 <ul style="list-style-type: none"> – Top-Down/Bottom-Up*add \$137 • Cordless Lift System*add \$80 <ul style="list-style-type: none"> – Two-On-One Headrail* price as 2 separate shades and add \$160 (not available in Top-Down/Bottom-Up) – Three-On-One Headrail* price as 3 separate shades and add \$239 (not available in Top-Down/Bottom-Up) – Top-Down/Bottom-Up*add \$160 	<ul style="list-style-type: none"> • Cordless Lift & Lock <ul style="list-style-type: none"> – Top-Down/Bottom-Up*add \$80 – Premium Headrail Upgrade*add \$15 (Premium Headrail not available with Top-Down/Bottom-Up or TriLight) • Cordless Extension Pole #40-0036-000\$39 • Rectangular Shade and Arch – price as 2 separate shades; One Arch and One Rectangular • TriLight Shades – see pages 23-28 • Angle Cutadd \$128

*NOTE: FABRIC-WRAPPED RAILS ARE OPTIONAL FOR A SURCHARGE ON CONTINUOUS CORD LOOP, CORDLESS LIFT, CORDLESS LIFT & LOCK, AND MOTORIZED SHADES. COLOR-COORDINATED RAILS ARE AVAILABLE AT NO ADDITIONAL CHARGE.

See page 17 for motorization surcharges

GROUP 7-SS (Standard Rectangular)

SOFT STYLE 3/4" BLACKOUT (S23)

WIDTH TO:	24"	30"	36"	42"	48"	54"	60"	66"	72"	84"	96"	108"	120"
HEIGHT TO:													
36"	\$148	165	187	207	229	251	272	293	315	359	405	450	499
42"	159	179	204	228	251	277	297	323	350	401	450	501	557
48"	173	196	226	252	278	307	333	362	392	448	509	567	630
54"	185	208	239	273	303	332	361	394	425	490	555	620	687
60"	202	222	257	293	323	357	389	425	460	529	601	672	742
66"	208	236	273	310	349	381	416	457	492	567	646	725	802
72"	222	253	294	334	374	413	450	496	532	617	704	784	873
78"	234	267	310	353	396	439	480	526	567	656	749	837	929
84"	244	280	327	374	418	462	506	557	601	697	792	886	984
90"	257	296	350	395	444	494	541	592	644	746	846	951	1056
96"	267	310	362	414	468	519	567	622	676	782	894	1003	1114
108"	288	336	396	454	513	570	624	687	743	862	983	1105	1229
120"	310	365	431	492	572	618	684	751	812	942	1075	1209	1340

CONTINUOUS CORD LOOP SYSTEM "REQUIRED" FOR SIZES TO THE RIGHT OF THE THICK BLACK LINE.

OPTIONS: NO EXTRA CHARGE

- Color-Coordinated Rails
- Cordless Lift & Lock
- Cordless Lift & Lock Two-On-One Headrail – price as 2 separate shades and add together
- Cordless Lift & Lock Three-On-One Headrail – price as 3 separate shades and add together
- Control Positions – left or right side of the shade (Exception: for Two-on-One Headrail, cords must be on opposite ends of the headrail)
- 3" Extension Bracket and 1/2" Spacer Blocks – maximum of 3 spacer blocks per bracket
- Hold Down Brackets
- Cut-Outs – up to 3" wide (see page 19 for details)
- Special Cord Lengths – standard cord is 40% of the height of the shade unless otherwise specified
- Hardware Color Override

OPTIONS: EXTRA CHARGE

- See "SIZE STANDARDS" for complete option details.
- Fabric-Wrapped Rail Optionadd \$23
 - Top-Down & Top-Down/Bottom-Upadd \$80
 - Continuous Cord Loop*add \$57
 - Top-Down/Bottom-Up*add \$137
 - Cordless Lift System*add \$80
 - Two-On-One Headrail* price as 2 separate shades and add \$160 (not available in Top-Down/Bottom-Up)
 - Three-On-One Headrail* price as 3 separate shades and add \$239 (not available in Top-Down/Bottom-Up)
 - Top-Down/Bottom-Up*add \$160
 - Cordless Lift & Lock
 - Top-Down/Bottom-Up*add \$80
 - Premium Headrail Upgrade*add \$15 (Premium Headrail not available with Top-Down/Bottom-Up or TriLight)
 - Cordless Extension Pole #40-0036-000\$39
 - Rectangular Shade and Arch – price as 2 separate shades; One Arch and One Rectangular
 - TriLight Shades – see pages 23-28
 - Angle Cutadd \$128

*NOTE: FABRIC-WRAPPED RAILS ARE OPTIONAL FOR A SURCHARGE ON CONTINUOUS CORD LOOP, CORDLESS LIFT, CORDLESS LIFT & LOCK, AND MOTORIZED SHADES. COLOR-COORDINATED RAILS ARE AVAILABLE AT NO ADDITIONAL CHARGE.

See page 17 for motorization surcharges

GROUP 8-SS (Standard Rectangular)

- SOFTSTYLE SUBDUE 3/4" SINGLE CELL BLACKOUT (S61)
- SOFTSTYLE DOUBLE CELL BLACKOUT (S32)

WIDTH TO:	24"	30"	36"	42"	48"	54"	60"	66"	72"	84"	96"	108"	120"
HEIGHT TO:													
36"	\$152	169	192	212	235	257	279	300	323	369	417	462	512
42"	163	184	209	234	257	285	306	332	359	412	462	515	571
48"	177	202	232	258	287	315	341	372	402	460	523	582	647
54"	190	214	247	280	312	340	371	404	437	504	570	636	706
60"	207	227	265	300	332	368	399	437	473	544	617	690	762
66"	214	243	280	317	357	392	427	468	506	582	663	743	823
72"	227	259	302	343	384	424	462	508	547	634	722	805	896
78"	240	274	317	362	407	450	492	540	582	674	770	860	954
84"	250	288	336	384	428	475	520	571	617	716	813	910	1011
90"	265	305	359	405	457	507	555	609	660	765	869	977	1085
96"	274	317	372	425	481	532	582	638	694	803	918	1030	1143
108"	296	345	407	466	528	586	641	706	763	885	1009	1134	1262
120"	317	376	442	506	588	635	701	771	834	967	1104	1241	1376

CONTINUOUS CORD LOOP SYSTEM "REQUIRED" FOR SIZES TO THE RIGHT OF THE THICK BLACK LINE.

OPTIONS: NO EXTRA CHARGE	
<ul style="list-style-type: none"> • Color-Coordinated Rails • Cordless Lift & Lock • Cordless Lift & Lock Two-On-One Headrail – price as 2 separate shades and add together • Cordless Lift & Lock Three-On-One Headrail – price as 3 separate shades and add together 	<ul style="list-style-type: none"> • Control Positions – left or right side of the shade (Exception: for Two-on-One Headrail, cords must be on opposite ends of the headrail) • 3" Extension Bracket and 1/2" Spacer Blocks – maximum of 3 spacer blocks per bracket • Hold Down Brackets • Cut-Outs – up to 3" wide (see page 19 for details) • Special Cord Lengths – standard cord is 40% of the height of the shade unless otherwise specified • Hardware Color Override

OPTIONS: EXTRA CHARGE	
<p>See "SIZE STANDARDS" for complete option details.</p> <ul style="list-style-type: none"> • Fabric-Wrapped Rail Optionadd \$23 • Top-Down & Top-Down/Bottom-Upadd \$80 • Continuous Cord Loop*add \$57 <ul style="list-style-type: none"> – Top-Down/Bottom-Up*add \$137 • Cordless Lift System*add \$80 <ul style="list-style-type: none"> – Two-On-One Headrail* price as 2 separate shades and add \$160 (not available in Top-Down/Bottom-Up) – Three-On-One Headrail* price as 3 separate shades and add \$239 (not available in Top-Down/Bottom-Up) – Top-Down/Bottom-Up*add \$160 	<ul style="list-style-type: none"> • Cordless Lift & Lock <ul style="list-style-type: none"> – Top-Down/Bottom-Up*add \$80 – Premium Headrail Upgrade*add \$15 (Premium Headrail not available with Top-Down/Bottom-Up or TriLight) • Cordless Extension Pole #40-0036-000\$39 • Rectangular Shade and Arch – price as 2 separate shades; One Arch and One Rectangular • TriLight Shades – see pages 23-28 • Angle Cutadd \$128

*NOTE: FABRIC-WRAPPED RAILS ARE OPTIONAL FOR A SURCHARGE ON CONTINUOUS CORD LOOP, CORDLESS LIFT, CORDLESS LIFT & LOCK, AND MOTORIZED SHADES. COLOR-COORDINATED RAILS ARE AVAILABLE AT NO ADDITIONAL CHARGE.

See page 17 for motorization surcharges

2" HYBRID PLEAT (Standard Rectangular)

NOTE: A control option must be selected.

• 2" HYBRID PLEAT - SEMI-OPAQUE

WIDTH TO:	18"	24"	28"	32"	36"	42"	48"	54"	60"	66"	72"	78"	84"	90"	96"	108"	120"
HEIGHT TO:																	
30"	\$148	154	169	176	183	205	217	233	245	295	311	330	346	359	376	449	525
36"	154	157	175	183	193	214	230	247	263	314	332	352	368	385	403	480	560
42"	157	171	182	190	202	224	241	260	276	333	352	374	390	409	428	512	597
48"	162	176	188	199	211	235	268	275	292	350	373	395	414	434	453	545	632
54"	165	183	194	206	218	244	275	285	306	370	391	417	437	460	480	572	666
61"	169	189	204	217	229	257	292	303	319	390	412	443	466	491	511	606	705
66"	183	202	219	233	244	267	294	312	335	409	430	461	483	511	534	636	739
73"	184	209	225	240	251	278	300	329	352	428	453	487	513	542	562	669	
78"	214	242	260	279	299	325	353	386	414	443	471	502	530	561	587	699	
84"	219	248	268	286	306	336	368	403	430	461	492	525	553	585	615		
90"	225	257	276	299	316	349	379	416	448	479	512	548	578	611	640		
96"	230	264	284	306	328	359	393	431	464	498	531	568	600	634			
108"	250	290	315	341	368	407	448	492	531	570	612	655					
120"	269	315	348	377	408	453	500	551	598	644	691						

OPTIONS: NO EXTRA CHARGE

- Color-Coordinated Rails
- Cordless Lift & Lock
- Cordless Lift & Lock Two-On-One Headrail – price as 2 separate shades and add together
- Cordless Lift & Lock Three-On-One Headrail – price as 3 separate shades and add together
- Control Positions – left or right side of the shade (Exception: for Two-on-One Headrail, cords must be on opposite ends of the headrail)
- 3" Extension Bracket and 1/2" Spacer Blocks – maximum of 3 spacer blocks per bracket
- Hold Down Brackets
- Hardware Color Override

OPTIONS: EXTRA CHARGE

- See "SIZE STANDARDS" for complete option details.
- Fabric-Wrapped Rail Optionadd \$23
 - Top-Down & Top-Down/Bottom-Upadd \$80
 - Continuous Cord Loop*add \$57
 - Top-Down/Bottom-Up*add \$137
 - Cordless Lift System*add \$80
 - Two-On-One Headrail* price as 2 separate shades and add \$160 (not available in Top-Down/Bottom-Up)
 - Three-On-One Headrail* price as 3 separate shades and add \$239 (not available in Top-Down/Bottom-Up)
 - Top-Down/Bottom-Up*add \$160
 - Cordless Lift & Lock
 - Top-Down/Bottom-Up*add \$80
 - Premium Headrail Upgrade*add \$15 (Premium Headrail not available with Top-Down/Bottom-Up or TriLight)
 - Cordless Extension Pole #40-0036-000\$39
 - TriLight Shades – see pages 23-28

*NOTE: FABRIC-WRAPPED RAILS ARE OPTIONAL FOR A SURCHARGE ON CONTINUOUS CORD LOOP, CORDLESS LIFT, CORDLESS LIFT & LOCK, AND MOTORIZED SHADES. COLOR-COORDINATED RAILS ARE AVAILABLE AT NO ADDITIONAL CHARGE.
NOTE: 2" HYBRID PLEAT IS NOT AVAILABLE WITH POWERWAND MOTORIZATION.

See page 17 for motorization surcharges

2" HYBRID PLEAT (Standard Rectangular)

NOTE: A control option must be selected.

• 2" HYBRID PLEAT - BLACKOUT (GCR)

WIDTH TO:	18"	24"	28"	32"	36"	42"	48"	54"	60"	66"	72"	78"	84"	90"	96"	108"	120"
HEIGHT TO:																	
30"	\$187	200	212	220	231	257	271	295	310	370	391	414	435	454	471	564	659
36"	192	208	219	230	243	269	287	311	329	395	416	441	462	484	505	605	707
42"	197	215	227	242	253	282	301	328	349	418	440	470	491	516	538	646	750
48"	201	220	239	249	263	295	316	346	366	440	466	496	520	548	571	684	795
54"	208	229	247	259	277	307	332	359	385	464	491	525	550	579	605	722	838
61"	212	240	255	271	285	322	349	379	399	491	519	557	585	616	640	764	885
66"	229	253	278	293	306	334	359	394	421	511	545	579	610	641	672	801	929
73"	235	260	283	301	315	349	376	412	440	538	569	613	644	681	708	843	
78"	269	304	328	351	376	409	444	487	520	557	591	634	669	704	740	878	
84"	287	329	356	385	411	454	494	545	585	626	669	716	755	798	840		
90"	316	361	392	422	454	497	547	597	642	687	738	784	832	878	924		
96"	338	396	436	474	511	570	629	695	750	811	870	933	991	1050			
108"	392	472	520	571	625	700	779	863	938	1014	1096	1176					
120"	432	528	588	652	717	811	906	1007	1099	1190	1290						

OPTIONS: NO EXTRA CHARGE

- Color-Coordinated Rails
- Cordless Lift & Lock
- Cordless Lift & Lock Two-On-One Headrail – price as 2 separate shades and add together
- Cordless Lift & Lock Three-On-One Headrail – price as 3 separate shades and add together
- Control Positions – left or right side of the shade (Exception: for Two-on-One Headrail, cords must be on opposite ends of the headrail)
- 3" Extension Bracket and 1/2" Spacer Blocks – maximum of 3 spacer blocks per bracket
- Hold Down Brackets
- Hardware Color Override

OPTIONS: EXTRA CHARGE

- See "SIZE STANDARDS" for complete option details.
- Fabric-Wrapped Rail Optionadd \$23
 - Top-Down & Top-Down/Bottom-Upadd \$80
 - Continuous Cord Loop*add \$57
 - Top-Down/Bottom-Up*add \$137
 - Cordless Lift System*add \$80
 - Two-On-One Headrail* price as 2 separate shades and add \$160 (not available in Top-Down/Bottom-Up)
 - Three-On-One Headrail* price as 3 separate shades and add \$239 (not available in Top-Down/Bottom-Up)
 - Top-Down/Bottom-Up*add \$160
 - Cordless Lift & Lock
 - Top-Down/Bottom-Up*add \$80
 - Premium Headrail Upgrade*add \$15 (Premium Headrail not available with Top-Down/Bottom-Up or TriLight)
 - Cordless Extension Pole #40-0036-000\$39
 - TriLight Shades – see pages 23-28

*NOTE: FABRIC-WRAPPED RAILS ARE OPTIONAL FOR A SURCHARGE ON CONTINUOUS CORD LOOP, CORDLESS LIFT, CORDLESS LIFT & LOCK, AND MOTORIZED SHADES. COLOR-COORDINATED RAILS ARE AVAILABLE AT NO ADDITIONAL CHARGE.
NOTE: 2" HYBRID PLEAT IS NOT AVAILABLE WITH POWERWAND MOTORIZATION.

See page 17 for motorization surcharges

SIMPLICITY SURCHARGE AND OPTIONS
EXTRA CHARGE – SPECIFY ON ORDER
USE APPROPRIATE HONEYCOMB SHADE GRID FOR SHADE PRICE, THEN ADD EXTRA CHARGE(S) BELOW.

- **Standard Simplicity Motorization** (Battery wand included in the price)add \$274 per shade
 - 5 Channel Remote Control (Black Part #CS5138 or White Part #CS5138W).....add \$46 each
 - 14 Channel Remote – Available in White Only (Part #CS52136).....add \$69 each
 - 48" Extension Wire (Part #CS5133Z)add \$8 each
 - DC Power Supply (Part #CS5151).....add \$38 each

- **Simplicity Rechargeable Motorization**add \$274 per shade
 - 2-on-1 Headrailprice as 2 separate shades
 - 5 Channel Remote Control (Black Part #CS5138 or White Part #CS5138W).....add \$46 each
 - 14 Channel Remote – Available in White Only (Part #CS52136).....add \$69 each
 - 48" Extension Wire (Part #CS5133Z)add \$8 each
 - Solar Panel (Part #CS52096)add \$166 each
 - Plug-In Charger (Part #CS5199).....add \$35 each

- **Simplicity Rechargeable Top-Down/Bottom-Up**add \$274 per shade + TD/BU Surcharge \$80 per shade
 - 14 Channel Remote – Available in White Only (Part #CS52136).....add \$69 each
 - 48" Extension Wire (Part #CS5133Z)add \$8 each
 - Solar Panel (Part #CS52096)add \$166 each
 - Plug-In Charger (Part #CS5199).....add \$35 each

- **PowerWand™**add \$126 per shade
 - PowerWand™ Options (must be specified): **No Charge**
 - 1) Control Side (Left or Right)
 - 2) Wand Color (Black or White)
 - 3) Wand Length:
 - 1 foot (12")
 - 2 feet (24")
 - 3 feet (36")
 - 4 feet (48")
 - 5 feet (60")
 - Plug-In Charger (Part #CS5199).....add \$35 each

Note: 2" Hybrid Pleat is Not Available with PowerWand™ Motorization

REMOTELIFT 2.0 SURCHARGE AND OPTIONS

- **RemoteLift 2.0**.....add \$316
- **Remote Control #2984495100**add \$60
- **Wireless Wall Switch #2986350100**.....add \$82
- **RemoteLift Top-Down**add \$49
- **Satellite Battery Pack #KIT2520** – select with wire length below:
 - Satellite Battery Pack (15" Wire) #2989899000add \$70
 - Satellite Battery Pack (4' Wire) #2989900000add \$76
 - Satellite Battery Pack (10' Wire) #2989901000add \$88
 - Satellite Battery Pack (20' Wire) #2989902000add \$97
- **18V DC Power Supply #7806000000** – select with wire length below:
 - DC Power Supply (15" Wire) #2989899000add \$102
 - DC Power Supply (4' Wire) #2989900000add \$104
 - DC Power Supply (10' Wire) #2989901000add \$108
 - DC Power Supply (20' Wire) #2989902000add \$112
- **Daisy Chain cable option requires DC Power Supply**
Daisy Chain Adapter (Select with wire length below) #2989875000
 - (with 15" cable) #2989899000add \$51
 - (with 4' cable) #2989900000add \$57
 - (with 10' cable) #2989901000add \$62
 - (with 20' cable) #2989902000add \$68
- **Momenta** (must be submitted as part order)
 - **Momenta App Bridge Kit #2920072100** add \$128 NET Cost
 - **Momenta Extender Kit #2920075100**add \$47 NET Cost

REMOTELIFT 2.0 SPECIFICATIONS HAVE BEEN UPDATED. PLEASE VERIFY SIZE RESTRICTIONS ON PAGE 31 PRIOR TO ORDERING.

RECTANGULAR CONFIGURATION SPECIFICATIONS

NOTE: Use metal tape measure for all measurements. Measures to 1/8 inch.

STANDARD RECTANGLE – STANDARD CORDLOCK

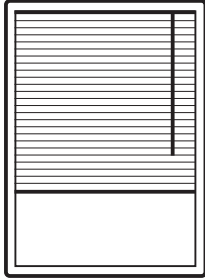

- Headrail Color – color coordinated with fabric
- Installs with standard snap-in brackets
- End mount brackets also available
- Standard cord length is 40% of the height of the shade unless otherwise specified

2" Hybrid Pleat is not available with standard cordlock.

STANDARD RECTANGULAR – SIZE STANDARDS

	All Single Cell Semi-Opaque	All Double Cell Semi-Opaque	Subdue Blackout (S61)	All other Blackout Fabrics
Min. Width (net)*	8"	8"	8"	8"
Max. Width	60"	60"	60"	60"
Max. Width-End Mount	36"	36"	36"	36"
Min. Height	12"	12"	12"	12"
Max. Height*	120"	120"	120"	120"
Max. Area (sq. ft.)	50	40	40	60

* For shades under 12" widths, the maximum height is 80"

NOTE: Standard Cordlock is **not available** with 2" Hybrid Pleat Fabrics

FINISHED DIMENSIONS

Adjustments are taken from ordered dimensions.

Inside (IB) Mount	
Headrail unit	- 3/16"
Shade height	ordered height
Fabric width	- 3/8"
Outside (OB) Mount	
Headrail unit	ordered width
Shade height	ordered height
Fabric width	- 3/16"
End (EB) Mount	
Headrail unit	- 3/16"
Shade height	ordered height
Fabric width	- 3/8"
2 on 1 Headrail	
Gap between panels	- 1/4"

NOTE: Measurements may vary ± 1/8"

MOUNTING REQUIREMENTS

Use a metal tape measure for all measurements.

Inside (IB) Mount	
Minimum mounting depth:	
Standard installation bracket	1-1/4"
Swivel bracket	1/2"
Minimum mounting depth, flush mount:	
Standard installation bracket	2-1/4"
Swivel bracket	2"
End mount bracket	2"
Outside (OB) Mount	
Minimum flat vertical surface	1"

NOTE: Inside mount with hold down brackets deductions:

Headrail -1/2"

Fabric -5/8"

Bottomrail -1/2"

2 ON 1 HEADRAIL (PRICE AS 2 SEPARATE SHADES)

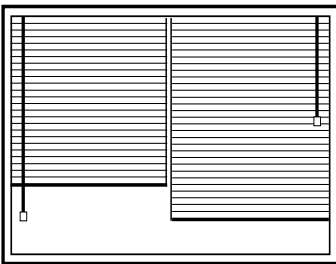

Cover patio doors and other large expanses by placing two independently operated shades side-by-side on the same headrail. Note: there will be a 1/4" minimum to a 1/2" maximum light gap between the two shades.

Finished Dimensions & Mounting Requirements:

see "Standard Rectangle" or "Continuous Cord" section.

STANDARD CORDLOCK TWO-ON-ONE – SIZE STANDARDS

	All Single Cell Semi-Opaque	All Double Cell Semi-Opaque	Subdue Blackout (S61)	All other Blackout Fabrics
Min. Width (per panel)	8"	8"	8"	8"
Min. Width (overall)	16"	16"	16"	16"
Max. Width (per panel)	60"	60"	60"	60"
Max. Width (overall)	120"	120"	120"	120"
Max. Width (end mount)	36"	36"	36"	36"
Min. Height	12"	12"	12"	12"
Max. Height	120"	120"	120"	120"
Max. Area (sq. ft.)	50	40	40	60

* For shades under 12" widths, the maximum height is 80"

NOTE: Standard Cordlock is **not available** with 2" Hybrid Pleat Fabrics

RECTANGULAR CONFIGURATION SPECIFICATIONS

NOTE: Use metal tape measure for all measurements. Measures to 1/8 inch.

TOP-DOWN OR TOP-DOWN/BOTTOM-UP – STANDARD CORDLOCK

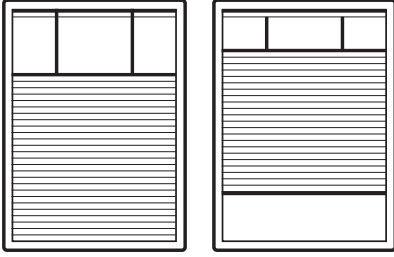

Conveniently open shades from the top down or from both top and bottom.

Installs with standard snap-in brackets

Top-Down/Bottom-Up features one cord connector tassel per pull cord.

Finished Dimensions & Mounting Requirements:

- See "Standard Rectangle" or "Cordless Lift" section.
- End mount brackets also available.

NOTE: Measurements may vary \pm 1/8"

NOTES:

- The standard TD/BU control positions are: RIGHT operates the top-middle moving rail and LEFT operates the bottom rail. REVERSE CONTROLS also are available (operate opposite as described above). Specify REVERSE CONTROLS when ordering.
- Standard cord length is 40% of the height of the shade unless otherwise specified.

STANDARD CORDLOCK TOP-DOWN – SIZE STANDARDS

	All Single Cell Semi-Opaque	All Double Cell Semi-Opaque	Subdue Blackout (\$61)	All other Blackout Fabrics
Min. Width (net)*	10"	10"	10"	10"
Max. Width	60"	60"	60"	60"
Max. Width-End Mount	36"	36"	36"	36"
Min. Height	12"	12"	12"	12"
Max. Height*	96"	96"	96"	96"
Max. Area (sq. ft.)	50	40	40	60

* For shades under 12" widths, the maximum height is 80"

NOTE: Standard Cordlock is **not available** with 2" Hybrid Pleat Fabrics

STANDARD CORDLOCK TOP-DOWN/BOTTOM-UP – SIZE STANDARDS

	All Single Cell Semi-Opaque	All Double Cell Semi-Opaque	Subdue Blackout (\$61)	All other Blackout Fabrics
Min. Width (net)*	10"	10"	10"	10"
Max. Width	72"	72"	72"	72"
Max. Width-End Mount	36"	36"	36"	36"
Min. Height	12"	12"	12"	12"
Max. Height*	96"	96"	96"	96"
Max. Area (sq. ft.)	50	40	40	60

* For shades under 12" widths, the maximum height is 80"

NOTE: Standard Cordlock is **not available** with 2" Hybrid Pleat Fabrics

On top-down/bottom-up shades a fabric insert is standard. This is an extra two-cell fabric gasket attached to the top headrail and acts as a seal to eliminate light leakage between the headrail and center rail when the shade is closed.

CUT-OUTS

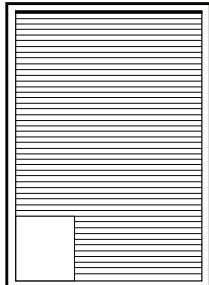

The portion of the shade above the cut-out will not stack tightly when the shade is raised.

Available on standard cordlock, continuous cord loop and RemoteLift bottom-up shades only.

Not available on 2" Hybrid Pleat shades.

CUT-OUTS - SIZE STANDARDS

Min. Cut-out Width	1/8"
Max. Cut-out Width	3"
Min. Shade Width	12"
Max. Shade Width	120"
Min. Shade Height	12"
Max. Shade Height	120"

RECTANGULAR CONFIGURATION SPECIFICATIONS

NOTE: Use metal tape measure for all measurements. Measures to 1/8 inch.

CORDLESS LIFT SYSTEM

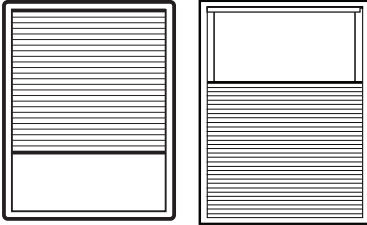

Uses steel snap-in brackets. Cordless easily lifts and lowers using the bottomrail handle. No lift cord is necessary.



All Cordless shades can be ordered with the fabric covered headrail and bottomrail for a surcharge, or with the color coordinated non-wrapped rails at no additional charge. Must be specified when order is placed.

Cordless cellular shades come with a color-coordinated textured handle pre-inserted, a clear textured handle or clear plastic insert are optional.

Shades over 42" will have two handles. Single handle available, must be selected during order entry.

Cut-Outs are not available.

	CORDLESS LIFT – SIZE STANDARDS			
	Cellular			2" Hybrid Pleat
	All Semi-Opaque Fabrics	Subdue Blackout (S61)	All other Blackout Fabrics	Semi-Opaque & Blackout
Min. Width (net)	16"	16"	16"	16"
Max. Width	120"	84"	96"	120"
Max. Width – End Mount	48"	48"	48"	42"
Min. Height	12"	12"	12"	12"
Max. Height	84"	84"	84"	84"
Max Area (sq. ft.)	70	49	56	60

Note: Cut-outs are not available on Cordless Lift shades.

	CORDLESS LIFT TOP-DOWN/BOTTOM-UP – SIZE STANDARDS			
	Cellular			2" Hybrid Pleat
	All Semi-Opaque Fabrics	Subdue Blackout (S61)	All other Blackout Fabrics	Semi-Opaque & Blackout
Min. Width (net)	16"	16"	16"	16"
Max. Width	96"	84"	96"	120"
Max. Width – End Mount	48"	48"	48"	42"
Min. Height	12"	12"	12"	12"
Max. Height	84"	84"	84"	84"
Max Area (sq. ft.)	56	49	56	60

Note: Cut-outs are not available on Cordless Lift shades.

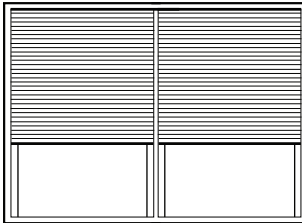

Top Down Bottom Up shades are now available with white striker plates and magnet caps when shades are ordered with fabric-wrapped rails. Zinc striker plates & magnets comes standard on shades ordered with color-coordinated rails. Striker plate & magnet placement:

Shades under 42" Wide – one magnet on each end of the shade

Shades 42" - 78" wide – one magnet on each end of the shade and one offset 3" from the center cord

Shades 78" - 96" wide – one magnet on each end of the shade and one in the center of the shade.

Shades over 96" wide – one magnet on each end of the shade and one at 3" to the left and right of the center routes.

	CORDLESS LIFT TWO-ON-ONE – SIZE STANDARDS			
	Cellular			2" Hybrid Pleat
	All Semi-Opaque Fabrics	Subdue Blackout (S61)	All other Blackout Fabrics	Semi-Opaque & Blackout
Min Width (per panel)	16"	16"	16"	16"
Min Width (overall)	32"	32"	32"	32"
Max Width (per panel)	100"	100"	100"	100"
Max Width (overall)	120"	120"	120"	120"
Min Height	12"	12"	12"	12"
Max Height	84"	84"	84"	84"
Max Area (per panel) (Sq/Ft)	70	49	70	60

* Two-On-One Headrail is not available in Top-Down/Bottom-Up or Trilight

Note: End mount not available. Not available with Hold Down Brackets

Note: Cut-outs are not available on Cordless Lift shades.

	CORDLESS LIFT THREE-ON-ONE – SIZE STANDARDS			
	Cellular			2" Hybrid Pleat
	All Semi-Opaque Fabrics	Subdue Blackout (S61)	All other Blackout Fabrics	Semi-Opaque & Blackout
Min Width (per panel)	16"	16"	16"	16"
Min Width (overall)	48"	48"	48"	48"
Max Width (per panel)	100"	120"	100"	120"
Max Width (overall)	174"	174"	174"	174"
Min Height	12"	12"	12"	12"
Max Height	84"	84"	84"	84"
Max Area (per panel) (Sq/Ft)	70	49	56	60

* Three-On-One Headrail is not available in Top-Down/Bottom-Up or Trilight

Note: End mount not available. Not available with Hold Down Brackets

Note: Cut-outs are not available on Cordless Lift shades.

FINISHED DIMENSIONS

Adjustments are taken from ordered dimensions.

	SoftStyle	2" Hybrid Pleat
Inside (IB) Mounts		
Headrail unit	- 1/4"	- 1/4"
Shade height	ordered height	ordered height
Fabric width	- 3/8"	- 3/8"
End (EB) Mounts		
Headrail unit	- 1/2"	- 1/2"
Shade height	ordered height	ordered height
Fabric width	- 5/8"	- 5/8"
Outside (OB) Mount		
Headrail unit	ordered width	ordered width
Shade height	ordered height	ordered height
Fabric width	- 1/8"	- 1/8"
2-on-1 & 3-on-1 Headrail		
Gap between panels	-1/4"	-1/4"

NOTE: Measurements may vary ± 1/8"

MOUNTING REQUIREMENTS

Use a metal tape measure for all measurements.

	SoftStyle	2" Hybrid Pleat
Inside (IB) & End (EB) Mounts		
Minimum mounting depth	3/4"	3/4"
Minimum mounting depth, flush mount:	2-1/8"	2-1/8"
Outside (OB) Mount		
Minimum flat vertical surface	1-1/2"	1-1/2"

NOTE: Inside mount with hold down brackets deductions:

Headrail -1/2"

Fabric -5/8"

Bottomrail -1/2"

RECTANGULAR CONFIGURATION SPECIFICATIONS

NOTE: Use metal tape measure for all measurements. Measures to 1/8 inch.

CORDLESS LIFT & LOCK SYSTEM

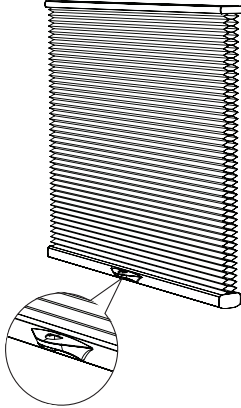

Press a button on the bottom rail to lift and lower the shade. Release the button to securely lock the shade into place.

No exposed cords on bottom up shades. Lift cords on Top-Down/Bottom-Up are on the far sides of the shade. Child-safe option.

All Cordless shades can be ordered with the fabric covered headrail and bottom rail **for a surcharge**, or with the color coordinated non -wrapped rails at **no additional charge. Must be specified** when order is placed.

Cordless Lift & Lock shades can be ordered with the Premium headrail **for a surcharge**. Premium headrail option is not available with Top-Down/Bottom-Up or TriLight.

CORDLESS LIFT & LOCK – SIZE STANDARDS			
	Cellular		2" Hybrid Pleat
	All Semi-Opaque Fabrics	All Blackout Fabrics	Semi-Opaque & Blackout
Min. Width (net)	9-1/2"	9-1/2"	9-1/2"
Max. Width	84"	84"	84"
Max. Width – End Mount	48"	48"	48"
Min. Height	12"	12"	12"
Max. Height	84"	84"	84"
Max Area (sq. ft.)	49	49	49

Top-Down/bottom-Up Lift & Lock shades under 42" will have one magnet in the middle.

Shades over 42" will have one magnet in the middle, and one approximately 3" from each end to provide better closure between the middle rail and top rail.

CORDLESS LIFT & LOCK TWO-ON-ONE & THREE-ON-ONE – SIZE STANDARDS			
	Cellular		2" Hybrid Pleat
	All Semi-Opaque Fabrics	All Blackout Fabrics	Semi-Opaque & Blackout
Min. Width (net - per panel)	9-1/2"	9-1/2"	9-1/2"
Min Width (overall)	20"	20"	20"
Max. Width (per panel)	84"	84"	84"
Max. Width (overall)	168"	168"	168"

Two-on-One

Min. Width (net - per panel)	9-1/2"	9-1/2"	9-1/2"
Min Width (overall)	20"	20"	20"
Max. Width (per panel)	84"	84"	84"
Max. Width (overall)	168"	168"	168"

Three-on-One

Min. Width (net - per panel)	9-1/2"	9-1/2"	9-1/2"
Min Width (overall)	30"	30"	30"
Max. Width (per panel)	84"	84"	84"
Max. Width (overall)	168"	168"	168"
Min. Height	12"	12"	12"
Max. Height	84"	84"	84"
Max Area (per panel) (sq. ft.)	49	49	49

NOTE: 2-on-1 or 3-on-1 Headrail is **not available** in Top-Down/Bottom-Up or Trilight or End Mount

CORDLESS LIFT & LOCK TOP-DOWN/BOTTOM-UP – SIZE STANDARDS

	Cellular		2" Hybrid Pleat
	All Semi-Opaque Fabrics	All Blackout Fabrics	Semi-Opaque & Blackout
Min. Width (net)	16"	16"	16"
Max. Width	84"	84"	84"
Max. Width – End Mount	48"	48"	42"
Min. Height	12"	12"	12"
Max. Height	84"	84"	84"
Max Area (sq. ft.)	49	49	49

FINISHED DIMENSIONS – STANDARD

Adjustments are taken from ordered dimensions.

	SoftStyle	2" Hybrid Pleat
Inside (IB) Mounts		
Headrail unit (includes end caps)	- 1/4"	- 1/4"
Shade height	ordered height	ordered height
Fabric width	- 3/8"	- 3/8"
End (EB) Mounts		
Headrail unit (includes end caps)	- 1/2"	- 1/2"
Shade height	ordered height	ordered height
Fabric width	- 5/8"	- 5/8"
Outside (OB) Mount		
Headrail unit (includes end caps)	ordered width	ordered width
Shade height	ordered height	ordered height
Fabric width	- 1/8"	- 1/8"
2-on-1 & 3-on-1 Headrail		
Gap between panels	-1/4"	-1/4"

NOTE: Measurements may vary ± 1/8"

MOUNTING REQUIREMENTS

Use a metal tape measure for all measurements.

	Standard Headrail	SoftStyle	2" Hybrid Pleat
Inside (IB) Mount			
Minimum mounting depth		1-1/4"	1-1/4"
Minimum mounting depth, flush mount:		2-1/4"	2-1/4"
End (EB) Mount			
Minimum flat vertical surface		2"	2"
Outside (OB) Mount			
Minimum flat vertical surface		1"	1"

	Premium Headrail	SoftStyle	2" Hybrid Pleat
Inside (IB) & End (EB) Mounts			
Minimum mounting depth		3/4"	3/4"
Minimum mounting depth, flush mount:		2-1/8"	2-1/8"
Outside (OB) Mount			
Minimum flat vertical surface		1-1/2"	1-1/2"

NOTE: Inside mount with hold down brackets deductions:

Headrail -1/2"

Fabric -5/8"

Bottomrail -1/2"

RECTANGULAR CONFIGURATION SPECIFICATIONS

NOTE: Use metal tape measure for all measurements. Measures to 1/8 inch.

CONTINUOUS CORD LOOP SYSTEM

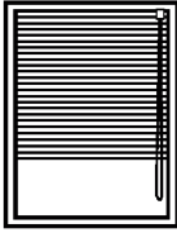

Uses steel snap-in brackets.

Continuous cord loop system easily lifts any shade – even large or hard-to-reach – and stops the shade exactly where you want. No more tangled cords!

All continuous cord loop shades can be ordered with the fabric covered headrail and bottomrail for a surcharge, or with the color coordinated non-wrapped rails at no additional charge. **Must be specified** when order is placed.

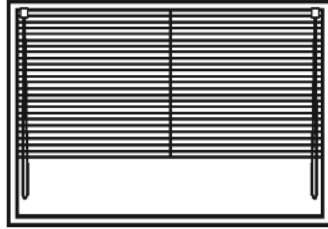
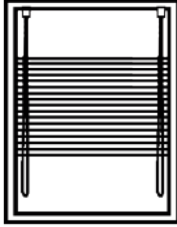

SHADE HEIGHT	CORD LOOP DROP
up to 18"	18" loop
18" to 42"	24" loop
42-1/8" - 54"	36" loop
54-1/8" - 72"	48" loop
72-1/8" - 90"	60" loop
90-1/8" - 110"	72" loop
110-1/8" - 130"	96" loop
130-1/8" - 144"	120" loop

FINISHED DIMENSIONS – STANDARD

Adjustments are taken from ordered dimensions.

SoftStyle 2" Hybrid Pleat*

Inside (IB) Mount		
Headrail unit	- 1/4"	- 1/4"
Shade height	ordered height	ordered height
Fabric width	- 3/8"	- 5/8"
End (EB) Mounts		
Headrail unit	- 1/2"	- 1/2"
Shade height	ordered height	ordered height
Fabric width	- 5/8"	- 7/8"
Outside (OB) Mount		
Headrail unit	ordered width	ordered width
Shade height	ordered height	ordered height
Fabric width	- 1/8"	- 3/8"

*An extra 1/4" deduction will be taken from the fabric with the Top-Down/ Bottom-Up option for Hybrid Pleat

NOTE: Measurements may vary ± 1/8"

FINISHED DIMENSIONS – 2 ON 1

Adjustments are taken from ordered dimensions.

SoftStyle 2" Hybrid Pleat

Inside (IB) Mount		
Headrail unit	- 1/4"	- 1/4"
Shade height	ordered height	ordered height
Fabric width (includes gap deduction)	- 5/8"	- 7/8"
Outside (OB) Mount		
Headrail unit	ordered width	ordered width
Shade height	ordered height	ordered height
Fabric width	- 1/8"	- 3/8"
2 on 1 Headrail		
Gap between panels	- 1/4"	- 1/4"

NOTE: Measurements may vary ± 1/8"

CONTINUOUS CORD LOOP – SIZE STANDARDS

	Cellular			2" Hybrid Pleat
	All Semi-Opaque Fabrics	Subdue Blackout (S61)	All other Blackout Fabrics	Semi-Opaque & Blackout
Min. Width (net)*	18"	18"	18"	18"
Max. Width	120"	120"	120"	120"
Max. Width – End Mount	48"	48"	48"	42"
Min. Height	12"	12"	12"	12"
Max. Height*	120"	120"	120"	120"
Max. Area (sq. ft.)	100	90	100	60

CONTINUOUS CORD LOOP TWO-ON-ONE – SIZE STANDARDS

	Cellular		2" Hybrid Pleat
	All Semi-Opaque Fabrics	All Blackout Fabrics	Semi-Opaque & Blackout
Min. Width (per panel)	18"	18"	18"
Min. Width (overall)	36"	36"	36"
Max. Width (per panel)	100"	96"	102"
Max. Width (overall)	120"	120"	120"
Min. Height	12"	12"	12"
Max. Height	120"	120"	120"
Max. Area (sq. ft.)	83	80	60

Note: End mount not available.

CONTINUOUS CORD LOOP TOP-DOWN/BOTTOM-UP – SIZE STANDARDS

	Cellular			2" Hybrid Pleat
	All Semi-Opaque Fabrics	Subdue Blackout (S61)	All other Blackout Fabrics	Semi-Opaque & Blackout
Min. Width (net)*	24"	24"	24"	24"
Max. Width	120"	120"	120"	120"
Max. Width – End Mount	48"	48"	48"	42"
Min. Height	12"	12"	12"	12"
Max. Height*	120"	120"	120"	120"
Max. Area (sq. ft.)	100	90	100	60

On top-down/bottom-up Cellular shades a fabric insert is standard (Does not apply to Hybrid Pleat). This is an extra two-cell fabric gasket attached to the top headrail and acts as a seal to eliminate light leakage between the headrail and center rail when the shade is closed.

Right control operates the center moving rail; left control operates the bottomrail. Reverse controls are available.

NOTE: Inside mount with hold down brackets deductions:
 Headrail -1/2"
 Fabric -5/8"
 Bottomrail -1/2"

MOUNTING REQUIREMENTS

Use a metal tape measure for all measurements.

SoftStyle 2" Hybrid Pleat

Inside (IB) Mounts		
Minimum mounting depth	3/4"	3/4"
Minimum mounting depth, flush mount:	2-1/8"	2-1/8"
Outside (OB) Mount		
Minimum flat vertical surface	1-1/2"	1-1/2"

SMART FACTS



- The beautiful combination of a sheer pleated shade on top and cellular or 2" Hybrid Pleat shade on the bottom provides maximum versatility in a single window covering.
- Wide array of color options from whites, neutrals, and muted tones to bold colors.
- Four sheer pleated styles in multiple colors to meet most decorating tastes.
- Semi-opaque and blackout cellular fabrics are available in multiple sizes, providing a choice for every window size and desired light and privacy control.
- Cellular fabric provides superior insulation for reduced heating and cooling bills. It also absorbs sound, making rooms more comfortable.
- The continuous cord loop option lifts any shade -- even large or hard-to-reach -- and positions it exactly where you want without any dangling cords.
- The Cordless and Cordless Lift & Lock options provide safe, simple operation by raising and lowering the shade using handles instead of cords. Ideal in homes with children and pets.

SELECTING A TRILIGHT SHADE

1. Choose a fabric, cell size and color for the bottom shade.
2. Choose a sheer pleated fabric for the top shade. See Sheer Pleated Color Chart.
3. Refer to the cellular and 2" Hybrid Pleat price grids on pages 7-16 to determine your bottom shade price.
4. Refer to the sheer pleated grids on page 25 to find your top shade price. Add the bottom shade, sheer pleated and control option prices together to determine your final price.
 - TriLight Shades are available as standard rectangle only.
 - Continuous Cord Loop – right operates the middle rail; left operates the bottom rail. Reverse controls are available; grouped controls are NOT available.

SHEER PLEATED COLOR CHART

Sheer Pleated Price Group A		
Style Name	Color #	Color Name
Nova Sheer	P33-824	Blush
Nova Sheer	P33-820	Bridal White
Nova Sheer	P33-823	Crème
Nova Sheer	P33-821	Glacier White
Nova Sheer	P33-822	Light Lemon
Nova Sheer	P33-825	Tea

Sheer Pleated Price Group B		
Style Name	Color #	Color Name
Carousel Sheer	P32-804	Blush
Carousel Sheer	P32-800	Bridal White
Carousel Sheer	P32-803	Crème
Carousel Sheer	P32-801	Glacier White
Carousel Sheer	P32-802	Light Lemon

Sheer Pleated Price Group A		
Style Name	Color #	Color Name
Willa Sheer	P05-506	Bisque
Willa Sheer	P05-508	Chocolate
Willa Sheer	P05-504	Crystal
Willa Sheer	P05-502	Heirloom
Willa Sheer	P05-501	Ice
Willa Sheer	P05-507	Latte
Willa Sheer	P05-505	Light Taupe
Willa Sheer	P05-500	Snow White
Willa Sheer	P05-503	Soft Ivory
Willa Sheer	P05-509	Twilight

Sheer Pleated Price Group B		
Style Name	Color #	Color Name
Lyssa Sheer	P04-405	Blush
Lyssa Sheer	P04-400	Bridal White
Lyssa Sheer	P04-402	Crème
Lyssa Sheer	P04-401	Glacier White
Lyssa Sheer	P04-403	Light Lemon
Lyssa Sheer	P04-407	Tea

SHEER PLEATED MAXIMUM WIDTHS		% UV BLOCKAGE
Nova Sheer	96"	60
Carousel Sheer	96"	60
Willa Sheer	83"	50
Lyssa Sheer	96"	60

NOTE: A control option must be selected.



Determine the top shade price by using the charts below.
Add the sheer pleated, bottom shade and control option prices together to determine your final price.

GROUP A (Sheer Pleated)

- Nova Sheer (96")
- Willa Sheer (83")

WIDTH TO:	24"	30"	36"	42"	48"	54"	60"	66"	72"	84"	96"
HEIGHT TO:											
36"	\$46	51	56	64	71	77	83	88	95	109	122
42"	49	55	61	71	77	83	90	99	105	120	136
48"	52	58	67	75	83	90	99	107	114	133	148
54"	55	61	72	81	88	98	107	114	125	142	162
60"	57	66	77	85	94	105	113	123	135	155	174
66"	60	71	82	90	103	111	121	134	143	164	188
72"	64	74	85	98	109	119	130	141	153	175	199
78"	67	78	90	102	114	126	138	149	163	188	212
84"	70	82	93	107	120	133	144	158	170	195	223
90"	73	85	99	111	126	139	153	166	181	209	236
96"	75	88	104	117	133	144	160	174	189	217	247

GROUP B (Sheer Pleated)

- Carousel Sheer (96")
- Lyssa Sheer (96")

WIDTH TO:	24"	30"	36"	42"	48"	54"	60"	66"	72"	84"	96"
HEIGHT TO:											
36"	\$54	60	70	77	85	92	101	107	116	131	148
42"	57	65	75	85	92	101	110	119	127	145	164
48"	61	71	81	90	101	110	119	129	139	160	181
54"	65	75	86	98	107	118	129	140	149	173	196
60"	70	80	92	104	113	127	138	149	162	187	211
66"	74	85	99	110	123	136	147	161	173	199	227
72"	77	89	104	117	131	144	158	172	186	214	243
78"	81	93	108	122	139	153	167	182	197	227	258
84"	84	99	113	129	144	160	175	191	206	237	270
90"	88	104	119	136	153	169	184	201	218	252	285
96"	90	107	125	142	160	175	193	211	228	264	300

OPTIONS: NO EXTRA CHARGE

- Cordless Lift – Single handle on shades over 42" wide
- Extension Brackets
- End Mount Brackets
- Hold Down Brackets
- Spacer Blocks
- Special Cord Loop Length
- Color Coordinated Rails

CONTROL OPTIONS

A CONTROL OPTION MUST BE SELECTED.

- Cordless Lift & Lock System.....No Charge
- Cordless Lift System.....add \$80
- Continuous Cord Loopadd \$57
- Fabric-Wrapped Rail Optionadd \$23

TRILIGHT CONFIGURATION SPECIFICATIONS

TRILIGHT – CONTINUOUS CORD LOOP

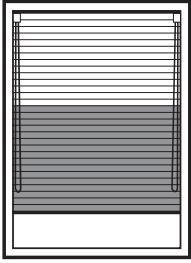

Features same headrail as continuous cord loop system.

Options:

- Color-Coordinated painted rails – no extra charge
– rails, end caps, cord loops, and cord tensioner will color-coordinate to the bottom (honeycomb) fabric
- Fabric wrapped rails - surcharge applies
– fabric wrap rails, end caps, cord loops, and cord tensioner will color-coordinate to the bottom (honeycomb) fabric
- Headrail can be fabric wrapped to match the top (sheer) fabric – surcharge applies
– Bottomrail, middle rail, end caps, cord loops, and cord tensioner will color-coordinate to the bottom (honeycomb) fabric

NOTES:

- Right loop control operates the middle rail, left loop control operates the bottomrail.

Cut-outs are not available on TriLight Shades.

CONTINUOUS CORD LOOP SIZE STANDARDS

	All Semi- Opaque Fabrics	All Blackout Fabrics	2" Hybrid Pleat
Min. Width (net)	24"	24"	24"
Max. Width*	83" - 96"	83" - 96"	83" - 96"
Max. Width-End Mount	48"	48"	42"
Min. Height	12"	12"	12"
Max. Height	96"	96"	96"
Max. Area (sq. ft.)	64	50	60
*See sheer pleated maximum width limitations			

FINISHED DIMENSIONS

Adjustments are taken from ordered dimensions.
Measurements may vary +/- 1/8".

	SoftStyle	2" Hybrid Pleat
Inside (IB) Mounts		
Headrail unit	- 1/4"	- 1/4"
Shade height	ordered height	ordered height
Fabric width	- 3/8"	- 7/8"
End (EB) Mounts		
Headrail unit	- 1/2"	- 1/2"
Shade height	ordered height	ordered height
Fabric width	- 5/8"	- 1-1/8"
Outside (OB) Mount		
Headrail unit	ordered width	ordered width
Shade height	ordered height	ordered height
Fabric width	- 1/8"	- 5/8"

MOUNTING REQUIREMENTS

Use a metal tape measure for all measurements.

	SoftStyle	2" Hybrid Pleat
Inside (IB) & End (EB) Mounts		
Minimum mounting depth	3/4"	3/4"
Minimum mounting depth, flush mount:	2-1/8"	2-1/8"
Outside (OB) Mount		
Minimum flat vertical surface	1-1/2"	1-1/2"

NOTE: Inside mount with hold down brackets deductions:

- Headrail -1/2"
- Fabric -5/8"
- Bottomrail -1/2"

TRILIGHT CONFIGURATION SPECIFICATIONS

TRILIGHT – CORDLESS

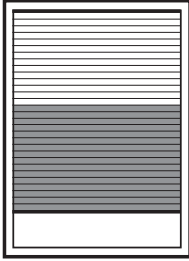

Sheer pleated lifts and lowers from the middle rail. Honeycomb and 2" Hybrid Pleat lift and lower from the bottomrail. No lift cords are necessary.

Options:

- Color-Coordinated painted rails - no extra charge – Headrail, bottomrail, and middle rail, end caps, cord loops, and handles will color-coordinate to the bottom (honeycomb) fabric
- Fabric wrapped rails - surcharge applies – Fabric wrapped headrail, bottomrail, and middle rail, end caps, cord loops, and handles will coordinate to the bottom (honeycomb) fabric
- Headrail can be fabric wrapped to match the top (sheer) fabric - surcharge applies – Bottomrail, end caps, cord loops, and handles will color-coordinate to the bottom (honeycomb) fabric

NOTES:

- Shades over 42" will have two handles in the middle rail and two handles in the bottomrail. Single handle available, must be selected during order entry.

Cut-outs are not available on TriLight Shades.

CORDLESS LIFT SYSTEM – SIZE STANDARDS			
	All Semi-Opaque Fabrics	All Blackout Fabrics	2" Hybrid Pleat
Min. Width (net)	16"	16"	16"
Max. Width**	83" - 96"	83"	83" - 96"
Max. Width-End Mount	48"	48"	42"
Min. Height	12"	12"	12"
Max. Height	84"	84"	84"
Max. Area (sq. ft.)	56	49	60

*See sheer pleated maximum width limitations.

FINISHED DIMENSIONS

Adjustments are taken from ordered dimensions. Measurements may vary +/- 1/8".

	SoftStyle	2" Hybrid Pleat
Inside (IB) Mounts		
Headrail unit	- 1/4"	- 1/4"
Shade height	ordered height	ordered height
Fabric width	- 3/8"	- 3/8"
End (EB) Mounts		
Headrail unit	- 1/2"	- 1/2"
Shade height	ordered height	ordered height
Fabric width	- 5/8"	- 5/8"
Outside (OB) Mount		
Headrail unit	ordered width	ordered width
Shade height	ordered height	ordered height
Fabric width	- 1/8"	- 1/8"

MOUNTING REQUIREMENTS

Use a metal tape measure for all measurements.

	SoftStyle	2" Hybrid Pleat
Inside (IB) & End (EB) Mounts		
Minimum mounting depth	3/4"	3/4"
Minimum mounting depth, flush mount:	2-1/8"	2-1/8"
Outside (OB) Mount		
Minimum flat vertical surface	1-1/2"	1-1/2"

NOTE: Inside mount with hold down brackets deductions:
 Headrail -1/2"
 Fabric -5/8"
 Bottomrail -1/2"

TRILIGHT CONFIGURATION SPECIFICATIONS

TRILIGHT – CORDLESS LIFT & LOCK

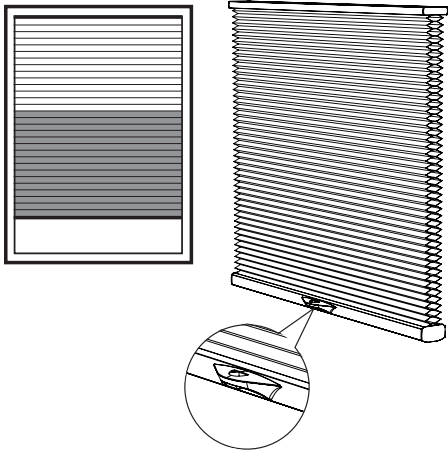

CORDLESS LIFT & LOCK – SIZE STANDARDS			
	All Semi- Opaque Fabrics	All Blackout Fabrics	2" Hybrid Pleat Fabrics
Min. Width (net)	12"	12"	12"
Max. Width	84"	84"	84"
Max. Width - End Mount	48"	48"	42"
Min. Height	12"	12"	12"
Max. Height	84"	84"	84"
Max. Area (sq. ft.)	49	49	49

*Maximum width on Whisper Sheer is 83", all other patterns 84".

Options:

- Color-Coordinated painted rails - no extra charge
 - Headrail, bottomrail, and middle rail, end caps, cord loops, and handles will color-coordinate to the bottom (honeycomb) fabric
- Fabric wrapped rails - surcharge applies
 - fabric wrapped headrail, bottomrail, and middle rail, end caps, cord loops, and handles will coordinate to the bottom (honeycomb) fabric

Must be specified when order is placed.

FINISHED DIMENSIONS

Adjustments are taken from ordered dimensions.
Measurements may vary +/- 1/8".

	SoftStyle	2" Hybrid Pleat
Inside (IB) Mounts		
Headrail unit	-1/4"	-1/4"
Shade height	Ordered Height	Ordered Height
Fabric width	-3/8"	-3/8"
End (EB) Mounts		
Headrail unit	-1/2"	-1/2"
Shade height	Ordered Height	Ordered Height
Fabric width	-5/8"	-5/8"
Outside (OB) Mount		
Headrail unit	Ordered Width	Ordered Width
Shade height	Ordered Height	Ordered Height
Fabric width	-1/8"	-1/8"

MOUNTING REQUIREMENTS

Use a metal tape measure for all measurements.

	SoftStyle	2" Hybrid Pleat
Inside (IB) & End (EB) Mounts		
Minimum mounting depth	1-1/4"	1-1/4"
Minimum mounting depth, flush mount:	2-1/4"	2-1/4"
End (OB) Mount		
Minimum flat vertical surface	2"	2"
Outside (OB) Mount		
Minimum flat vertical surface	1"	1"

NOTE: Inside mount with hold down brackets deductions:
Headrail -1/2"
Fabric -5/8"
Bottomrail -1/2"

MOTORIZATION CONFIGURATION SPECIFICATIONS

NOTE: Use metal tape measure for all measurements. Measures to 1/8 inch.

REMOTELIFT™ 2.0 BATTERY-OPERATED MOTORIZATION

- Fits rectangular window openings
- Remote control battery-operated operation
- Two stacking options: 1) standard bottom-up 2) top-down
- Features same headrail as used on Cordless Lift and Continuous Cord Loop. Fabric wrapped rails available for a surcharge or, non-fabric wrapped rails at no additional cost. Must be specified at the time the order is placed.

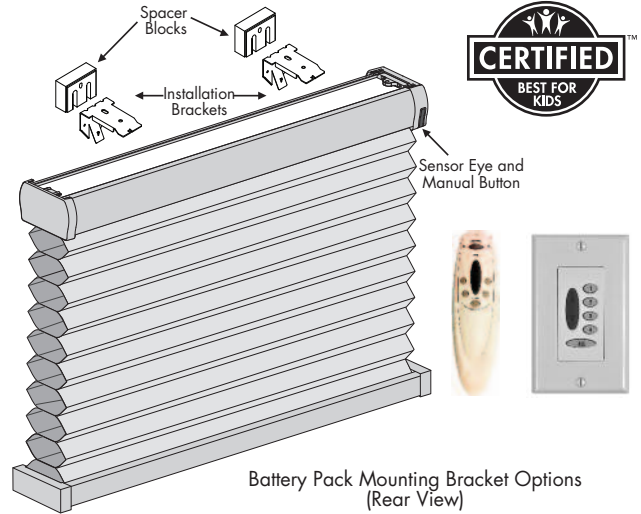

REMOTELIFT 2.0 – SIZE STANDARDS		
	All SoftStyle Fabrics	2" Hybrid Pleat
Minimum Width	18"	18"
Maximum Width	Refer to chart on page 31	
Max. Width, End Mount	36"	48"
Minimum Height	12"	12"
Maximum Height	Refer to chart on page 31	

** Max square footage for 2" Hybrid Pleat is 60 sq. feet

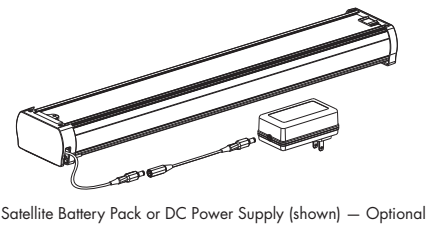
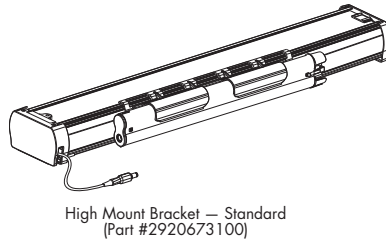
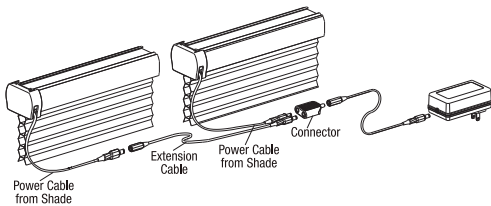

FINISHED DIMENSIONS

Adjustments are taken from ordered dimensions.

	SoftStyle	2" Hybrid Pleat
Inside (IB) Mounts		
Headrail unit	- 1/4"	- 1/4"
Shade height	ordered height	ordered height
Fabric width	- 3/8"	- 3/8"
End (EB) Mounts		
Headrail unit	- 1/2"	- 1/2"
Shade height	ordered height	ordered height
Fabric width	- 5/8"	- 5/8"
Outside (OB) Mount		
Headrail unit	ordered width	ordered width
Shade height	ordered height	ordered height
Fabric width	- 1/8"	- 1/8"

NOTE: Measurements may vary ± 1/8"

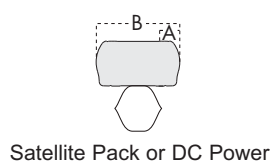
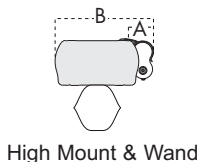

MOUNTING REQUIREMENTS

Use a metal tape measure for all measurements.

	SoftStyle	2" Hybrid Pleat
Inside (IB) & End (EB) Mounts		
Minimum mounting depth	1-1/2"	1-1/2"
Minimum mounting depth, flush mount:	2-7/8"	2-7/8"
Outside (OB) Mount		
Minimum flat vertical surface	1-1/2"	1-1/2"

With (Optional) Satellite Battery Pack or DC Power Supply

	SoftStyle	2" Hybrid Pleat
Inside (IB) & End (EB) Mounts		
Minimum mounting depth	3/4"	3/4"
Minimum mounting depth, flush mount:	2-1/8"	2-1/8"
Outside (OB) Mount		
Minimum flat vertical surface	1-1/2"	1-1/2"

IB with HDB deductions: Headrail -1/2"
Fabric -5/8"
Bottomrail -1/2"

REMOTELIFT 2.0 ORDERING NOTES

- Hardware colors will complement the fabric. Refer to the Hardware Color Guide for colors and more information.
- Specify left-side or right-side placement for sensor eye.
- Remote controls are ordered separately. Specify the number of remotes you desire.
- To operate multiple shades independently in Radio Frequency, additional remotes will need to be ordered if you have more than 4 shades.
- If ordering a satellite battery pack, specify wire length – 15', 4', 10' or 20'.
- If ordering the DC power supply, specify wire length – 15', 4', 10' or 20'.
- Specify "Channel 2" operation for independent operation of adjacent shades.

MOTORIZATION CONFIGURATION SPECIFICATIONS

REMOTELIFT™ 2.0 SYSTEM OPTIONS

BATTERY WAND

Battery wands are the standard power source whether inside (IB), outside (OB) or end (EB) mount, if applicable. Battery wands are mounted on the rear of the headrail. The redesigned battery wand will allow for batteries to be changed without removing the window covering from the window.

- 12 AA 1.5V alkaline batteries.
- Battery life is approximately one year, depending on usage.
- Replace batteries when the window covering(s) begin to operate slowly.



18V Battery Wand
(Part #7520062000)

SATELLITE BATTERY PACK

The satellite battery pack is an optional power source. The battery pack connects to the same side of the headrail where the receiver eye or satellite eye is located. The satellite battery pack is the best choice when the window covering is mounted in a high window, restricting access to a battery wand.

- 18V satellite battery pack:
 - Available in 15", 4', 10' and 20' wire lengths.
 - 12 AA 1.5V alkaline batteries.
- Battery life is approximately one year, depending on usage.
- Replace batteries when the window covering(s) begin to operate slowly.
- Mounting options: top of headrail, next to molding or under the sill.
- Satellite battery pack cover can be painted.



18V Satellite Battery Pack
(Part # KIT2791)

Wire Part #'s:
15" (Part #2989899000)
4ft (Part #2989900000)
10ft (Part #2989901000)
20ft (Part #2989902000)

DC POWER SUPPLY

The DC power supply is an optional power source. The DC power supply plugs into any standard household outlet.

- 18V DC power supply:
 - Available in 15", 4', 10' and 20' wire lengths.
- Eliminates need to change batteries.



18V DC Power Supply
(Part #7806000000)

DAISY CHAIN

The optional Daisy Chain Adapter allows up to 3 shades to run off of one DC power supply. You must specify the cable wire length when order is placed.

Note: Keep in mind which side the sensor eye is positioned on each side when determining daisy-chain length.



Daisy-Chain Adapter/Connector
(Part #2989875000)

SIZE STANDARDS – REMOTELIFT™ 2.0 MOTORIZATION

REMOTELIFT 2.0 MAXIMUM HEIGHTS – STANDARD AND TOP-DOWN																
CODE	SHADE WIDTH TO:	24"	30"	36"	42"	48"	54"	60"	66"	72"	78"	84"	90"	96"	108"	120"
Max Square Footage:		55 Square Feet														35 Square Feet
S50	SOFTSTYLE BEGINNINGS SEMI-OPAQUE - SINGLE CELL	108"	108"	108"	108"	108"	108"	108"	108"	108"	100"	94"	88"	90"	46"	42"
Max Square Footage:		55 Square Feet														35 Square Feet
S51	SOFTSTYLE BEGINNINGS SEMI-OPAQUE - DOUBLE CELL	108"	108"	108"	108"	108"	108"	108"	108"	108"	100"	94"	88"	90"	46"	42"
Max Square Footage:		55 Square Feet														35 Square Feet
S11	SOFTSTYLE SEMI-OPAQUE - SMALL SINGLE CELL	108"	108"	108"	108"	108"	108"	108"	108"	108"	100"	94"	88"	90"	46"	42"
Max Square Footage:		55 Square Feet														40 Square Feet
S21	SOFTSTYLE SEMI-OPAQUE - LARGE SINGLE CELL	108"	108"	108"	108"	108"	108"	108"	108"	108"	100"	94"	88"	90"	54"	48"
Max Square Footage:		30 Square Feet														20 Square Feet
S31	SOFTSTYLE SEMI-OPAQUE - DOUBLE CELL	108"	108"	108"	102"	90"	80"	72"	64"	60"	54"	50"	48"	44"	26"	24"
Max Square Footage:		45 Square Feet														20 Square Feet
S13	SOFTSTYLE BLACKOUT - SMALL SINGLE CELL	108"	108"	108"	108"	108"	108"	108"	98"	90"	82"	76"	72"	68"	26"	24"
Max Square Footage:		50 Square Feet														20 Square Feet
S23	SOFTSTYLE BLACKOUT - LARGE SINGLE CELL	108"	108"	108"	108"	108"	108"	108"	108"	100"	90"	84"	80"	74"	26"	24"
Max Square Footage:		25 Square Feet														
S32	SOFTSTYLE BLACKOUT - DOUBLE CELL	108"	108"	100"	84"	74"	66"	60"	54"	50"	46"	42"	40"	36"	n/a	
Max Square Footage:		25 Square Feet														
S61	SOFTSTYLE SUBDUE BLACKOUT - SINGLE CELL	108"	108"	100"	84"	74"	66"	60"	54"	50"	46"	42"	40"	36"	n/a	

Max Square Footage:		35 Square Feet														
HPF	2" HYBRID PLEAT - SEMI-OPAQUE	108"	108"	108"	108"	104"	92"	84"	76"	70"	64"	60"	56"	52"	n/a	
Max Square Footage:		30 Square Feet														
HPR	2" HYBRID PLEAT - BLACKOUT	108"	108"	108"	102"	90"	80"	72"	64"	60"	54"	50"	48"	44"	n/a	

NOTE: SPECIFICATIONS HAVE BEEN UPDATED. PLEASE REVIEW WHEN ORDERING.

REMOTELIFT 2.0

RemoteLift 2.0 uses a combination of two different types of wireless signals to control window coverings: radio waves and an infrared signal.

By combining these two signal methods, RemoteLift 2.0 gives consumers the best features and control in the industry. Whether opening a single window covering or partially closing a roomful of coverings at the same time, RemoteLift 2.0 provides the ultimate in control.

WHAT IS RADIO FREQUENCY?

Radio frequency (RF) in today's world simply refers to the use of radio waves of a given frequency to wirelessly send data from a transmitter to a receiver. RemoteLift 2.0 uses radio waves in the 2.4GHz (pronounced "gigahertz") frequency range to send commands from the remote or to the receiver at the window covering.

Radio waves, due to their nature, pass through solid objects and radiate in every direction. That means a remote sending an RF signal does not need to be pointed at a window covering in order to control it. The remote does not have to be in the same room as the window covering it operates nor does the satellite eye need to be visible.

People use products that send radio frequency signals every day. From cell phones and keyless car FOBs, to baby monitors and even garage door openers. Each device sends out RF signals (radio waves) to a receiver on the other end. If the receiver on the other end doesn't "hear" the signal being sent, nothing happens (or a cell phone call gets dropped).

Operational Distance of Radio Waves

Range of operation may vary due to common household construction, layout and other wireless devices in the home. Much like reception with a cell phone, there may be better locations within a home to use radio frequency than others.

WHAT IS INFRARED?

An infrared (IR) signal uses an invisible beam of energy to send commands from a limited distance (usually less than 30 feet) to an electronic device. Similar to a flashlight, a clear line of sight between the device sending the signal and the device receiving the signal is necessary. Likewise, an infrared beam reflects off solid surfaces, bouncing around a room, which could activate a window covering unintentionally.

Products that use an infrared signal as a means of communication are so common, people seldom think about it. The most common device that uses an infrared signal sent from a remote in today's world is the television. By pointing the TV remote at the television and pressing a button, the television responds by changing channels, changing the volume level or powering off.

Operational Distance of Infrared Signals

The maximum operational distance an infrared signal can travel is 30 feet or less in a straight line. There cannot be any physical obstructions (like a drapery, top-treatment or cornice) between the remote and the receiver eye.

Also, an infrared signal can be compromised by direct sunlight or bright interior light. Keep all infrared receivers out of direct sunlight for better operation.

REMOTELIFT™ 2.0 MOTORIZATION: OVERVIEW

REMOTELIFT 2.0

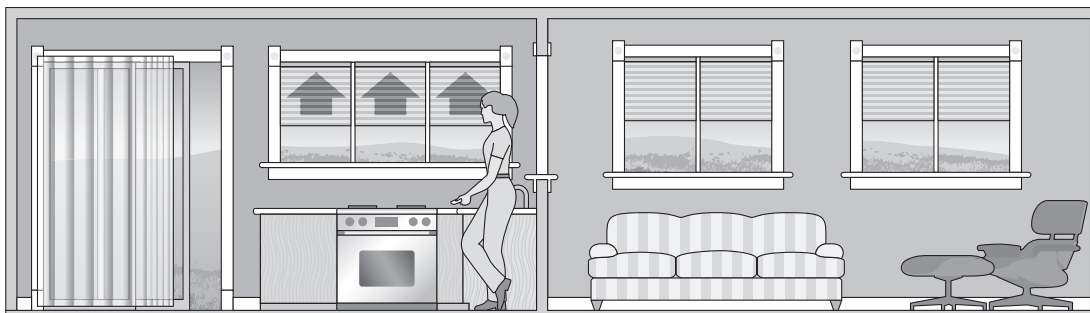

Operation of a group of window coverings using radio frequency.

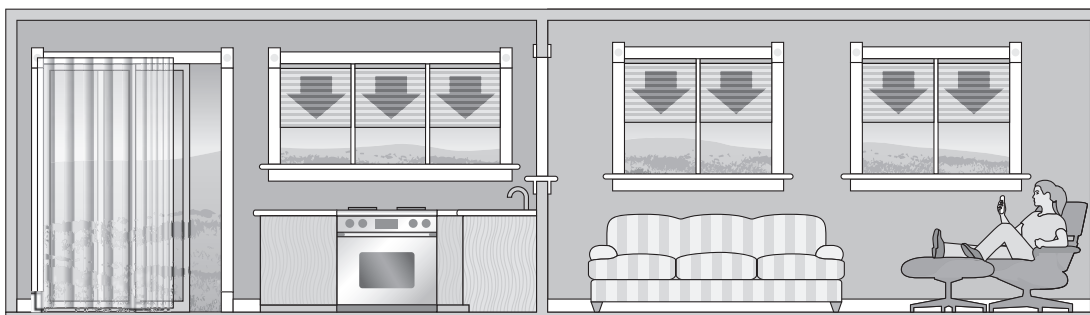

Operation of multiple groups of window coverings using radio frequency.

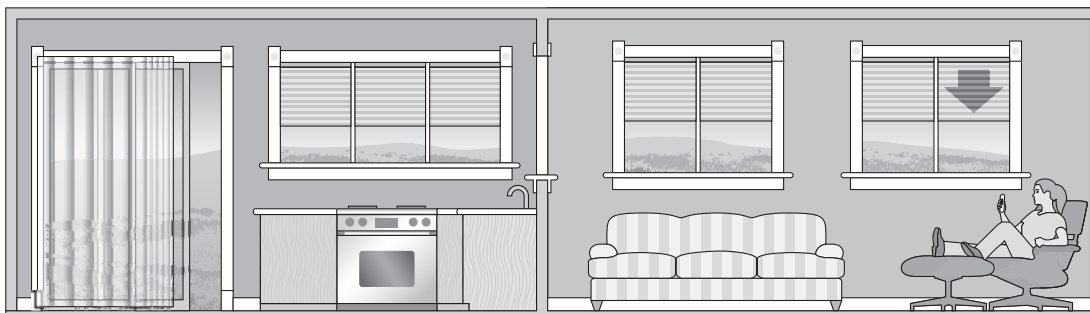

Operation of a single window covering using infrared or radio frequency.

SIMPLICITY MOTORIZATION SPECIFICATIONS POWERWAND™ MOTORIZATION SPECIFICATIONS

SIMPLICITY AND POWERWAND MOTORIZATION



- Features the same headrail and bottomrail as Cordless Lift, Continuous Cord Loop, and RemoteLift 2.0. Fabric wrapped rails are available **for a surcharge**. Color-coordinated rails are available at **no additional charge**. Must be specified when ordering.

Standard SIMPLICITY, SIMPLICITY Rechargeable & POWERWAND - SIZE STANDARDS		
	All Cellular Fabrics	2" Hybrid Pleat *
Minimum Width - Bottom-Up	18"	18"
Minimum Width - Top-Down/Bottom-Up	24"	24"
Maximum Width	96"	96"
Maximum Width, End Mount ***	36"	36"
Minimum Height	12"	12"
Maximum Height	96"	96"

** PowerWand **not available** with 2" Hybrid Pleat fabrics

*** Rechargeable Simplicity Top-Down/Bottom-Up **not available** as End Mount

NOTE: Size Standards are the same for standard Simplicity, Rechargeable Simplicity **Bottom-Up**, and PowerWand

NOTE: Min Width for Rechargeable Simplicity Top-Down/Bottom-Up is 24"

NOTE: Max height varies by width and fabric type. Refer to chart on page 39.

SIMPLICITY Rechargeable 2-on-1 HEADRAIL - SIZE STANDARDS		
	All Cellular Fabrics	2" Hybrid Pleat
Minimum Width (per panel)	20"	20"
Minimum Width (overall)	40"	40"
Maximum Width (per panel)	96"	96"
Maximum Width (overall)	144"	144"
Minimum Height	12"	12"
Maximum Height	96"	96"

NOTE: Simplicity 2-on-1 **ONLY** available with **Rechargeable** battery. **Not available** with standard Simplicity, PowerWand or Top-Down/Bottom-Up

NOTE: Max height varies by width and fabric type. Refer to chart on page 39.

FINISHED DIMENSIONS

Standard, Rechargeable Bottom-Up and Top-Down/Bottom-Up, and PowerWand

Adjustments are taken from ordered dimensions.

	Cellular	Hybrid Pleat
Inside (IB) Mounts		
Headrail unit	- 1/4"	- 1/4"
Shade height	ordered height	ordered height
Fabric width	- 3/8"	- 3/8"
Outside (OB) Mount		
Headrail unit	ordered width	ordered width
Shade height	ordered height	ordered height
Fabric width	- 1/8"	- 1/8"
End (EB) Mount*		
Headrail unit	- 1/2"	ordered width
Shade height	ordered height	ordered height
Fabric width	- 5/8"	- 1/8"

* End Mount is **not available** with Top-Down/Bottom-Up

Simplicity Rechargeable ONLY

2-on-1 Headrail		
Gap between panels	-1/4"	-1/4"

NOTE: 2-on-1 Headrail is **not available** with Top-Down/Bottom-Up

NOTE: Measurements may vary ± 1/8"

NOTE: PowerWand is **not available** with Hybrid Pleat fabrics

MOUNTING REQUIREMENTS

Standard, Rechargeable Bottom-Up, and PowerWand

Use a metal tape measure for all measurements.

Cellular & Hybrid Pleat	
Inside (IB) Mount	
Minimum mounting depth	3/4"
Minimum mounting depth, flush mount:	2-1/8"
Outside (OB) Mount	
Minimum flat vertical surface	1-1/2"

Rechargeable Top-Down/Bottom-Up Mounting Requirements

Use a metal tape measure for all measurements.

Cellular & Hybrid Pleat	
Inside (IB) Mount	
Minimum mounting depth	3/4"
Minimum mounting depth, flush mount	
Over 36" wide	2-1/4"
Under 36" wide (spacer blocks required)	3"

Outside (OB) Mount	
Minimum flat vertical surface	1-1/2"

STANDARD SIMPLICITY MOTORIZATION: OVERVIEW

Standard Simplicity Motorization

- Standard Simplicity Motorization features either a battery powered motor utilizing a single battery wand or plug-in DC transformer. Simplicity motors are compact and use a radio controlled remote to raise or lower the shades.
- Either batteries or 12 Volt DC power supply/transformer is available. The battery wand can be clipped to the headrail or wall or ceiling mounted utilizing battery wand clips. The 12 volt battery wand measures 17", and comes with eight AA alkaline batteries, and is white in color. The battery wire is 10" long. The DC power supply is white and comes with a 80" wire, must be plugged into a standard outlet to power the motor and can power a single shade.
- A 48" extension wire is available (Part #CS5133Z).



SIMPLICITY RECHARGEABLE MOTORIZATION: OVERVIEW

Simplicity Rechargeable

- The Rechargeable Simplicity motor program features an integrated rechargeable lithium ion battery in the motor casing and is fully concealed by the inner tube.
- Rechargeable battery is included with the motor. The average battery charge will last 6-12 months based on an average sized shade raised and lowered once per day. The life of the battery charge will vary based on the type of window covering selected, the size and weight of the window covering and the number of times the shade is operated on a daily basis. The battery can be recharged up to 500 times. It takes approximately 5 hours to recharge the motor when fully depleted.

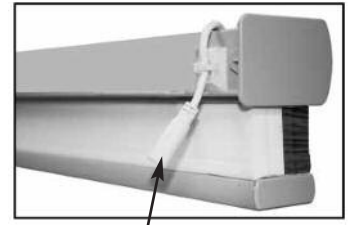

Charging Port

Battery Charger

- An 8.4 Volt charger requires a standard power outlet to recharge the battery. The charger must be specified when ordering Simplicity Rechargeable Motorized shade option. The charger plugs into the charging port of the motor. The charger is black and comes with a 156" wire. The dimensions are 1" wide x 2-1/2" length x 1-3/4" deep. Sold separately.



(Part #CS5199)

Solar Panel Recharge Option

- Plugs in to any Simplicity Rechargeable motorized shading (does not work with PowerWand™). Provides constant trickle charge to 7.4v Li-ION Rechargeable battery packs. Does not require direct sunlight, but performs best in regular direct sunlight applications. Will prolong the life of the charge of the 7.4v rechargeable battery packs, and in some applications will maintain charge indefinitely.
- Life of charge is subject to application variables such as, size and weight of shade, frequency of use, amount of direct sunlight exposure, etc.



(Part #CS52096)

Dimensions of panel
18 1/2" x 1 1/2"

5 Channel Remote

- The remote can operate up to five shadings simultaneously, individually or in groups. Remotes and holders are available in white or black. The remote comes with a holder which can be mounted to a wall for easy storage. The range of the remote is approximately 80 feet.



White
(Part #CS5138W)

Black
(Part #CS5138)

Please Note:

- Not all motors run at the same rate of speed.
- Simplicity motors have a "Favorites" position setting. To set a "Favorites" position, follow instructions provided in the installation instructions.

SIMPLICITY RECHARGEABLE TOP-DOWN/BOTTOM-UP: OVERVIEW

Rechargeable Simplicity Motors

- The Simplicity TDBU Motor program features a battery powered motor utilizing a rechargeable battery hidden inside the shade head rail. If shades are less than 36" in width, an external snap-on battery pack is necessary.

Top-Down/Bottom-Up Simplicity 14 Channel Remote

- The TDBU remote has 14-channels and an ALL option. Each channel has a setting able to operate the middle rail and a setting able to operate the bottom rail. The TDBU remote is required for TDBU motors, but can be used with other motors as well. The 14 Channel TDBU remote can operate up to fourteen shades individually or 14 groups (not recommended). Simplicity Rechargeable Motorized Cellular Shades are programmed at the factory with the "up and down" limits. Please ensure each shade is linked to the remote prior to installation.
- Simplicity TDBU remotes and holders are white in color. The remote comes with a holder which can be mounted to a wall for easy storage. The range of the remote is approximately 80 feet. The 14 Channel remote can be utilized on all Simplicity motorized shades.



(Part #CS52136)

Simplicity Rechargeable Battery for Top-Down/Bottom-Up

- For shades 36" and wider the rechargeable battery is fully concealed in the head rail and is recharged via a charging port on the back of the shade. Shades under 36" in width require an externally mounted battery pack. Both the internal and external rechargeable batteries come fully charged from the factory.



Internal Battery charging port



External Battery Pack

Battery Charger

- Utilizes the same 8.4 Volt charger as Simplicity Rechargeable Bottom-Up and PowerWand



(Part #CS5199)

Solar Panel Recharge Option

- Uses the same Solar Panel recharge option as Simplicity Rechargeable Bottom-up.



(Part #CS52096)

Dimensions of panel
18½" x 1½"

POWERWAND™ MOTORIZATION: OVERVIEW

PowerWand™ Motorization

- Honeycomb Shades can be fabricated with the PowerWand™ Rechargeable Push Button Control option. The PowerWand™ Rechargeable option is an easy, cord free motorized operation for the budget savvy homeowner. PowerWand™ Rechargeable uses Simplicity motors and components.

PowerWand™ Rechargeable Shades Operation

- Press the up or down button on the pendant to raise or lower the shading to your desired position. No programming is required with PowerWand™ as upper and lower limits are set at the factory. If desired, upper and lower limits can be adjusted in the field.
- Please refer to the installation instructions for instructions on resetting the upper and lower limits and setting a favorites position can be programmed on-site.

PowerWand™ Appearance

- The PowerWand™ Rechargeable wand and pendant is attached to the head rail and requires no additional mounting.
- The wand and pendant hangs down the front of the shades from the head rail.
- Pendant is 2-1/2" long.
- The pendant does not need to be mounted to the wall to operate the shade.



PowerWand™ Options

- Wand is available in Black or White (there is no default)
- Wand is available in 1 foot increments from 1 to 5 feet (there is no default)
- Wand is available on either the right or left side of the shade (there is no default)



White



Black Shown with Plug-In Charger

PowerWand™ Battery Life

- The battery life will vary based on the type of window covering selected, the size and weight of the window covering and the number of times you operate the blind on a daily basis.

Battery Charger

- 8.4 Volt charger requires a standard power outlet to recharge the battery. The charger must be specified when ordering the PowerWand™ motorization option. The charger plugs into the charger port on the side of the pendant. The charger is black and comes with a 156" wire. The dimensions are 1" wide x 2-1/2" length x 1-3/4" deep.



(Part #CS5199)

Note: PowerWand™ is NOT AVAILABLE with 2" Hybrid Pleat Shades

SIZE STANDARDS – SIMPLICITY MOTORIZATION

SIMPLICITY MOTORIZATION (Bottom-Up and Top-Down/Bottom-Up*) & POWERWAND - MAXIMUM HEIGHTS				
CODE	SHADE WIDTH TO:	18" – 72" *	84"	96"
S50	SoftStyle Beginnings Semi-Opaque - Single Cell	96"	96"	96"
S51	SoftStyle Beginnings Semi-Opaque - Double Cell	96"	96"	96"
S11	SoftStyle Semi-Opaque - Small Single Cell	96"	96"	96"
S21	SoftStyle Semi-Opaque - Large Single Cell	96"	96"	96"
S31	SoftStyle Semi-Opaque - Double Cell	96"	90"	72"
S13	SoftStyle Blackout - Small Single Cell	96"	96"	96"
S23	SoftStyle Blackout - Large Single Cell	96"	96"	96"
S32	SoftStyle Blackout - Double Cell	96"	90"	72"
S61	SoftStyle Subdue Blackout - Single Cell	96"	90"	72"
HPF	2" Hybrid Pleat Semi-Opaque**	96"	96"	96"
HPR	2" Hybrid Pleat - Blackout**	96"	90"	72"

* **2-on-1 Minimum Panel Width 20"** (available with **Bottom-Up Simplicity Rechargeable ONLY**)

* **Top-Down/Bottom-Up Minimum Panel Width 24"** (available with **Simplicity Rechargeable ONLY**)

****2" Hybrid Pleat is Not Available with PowerWand Motorization**

- SOFTSTYLE 3/4" BEGINNINGS SEMI-OPAQUE (S50)
- SOFTSTYLE 3/4" SEMI-OPAQUE (S21)

GROUP A-SS (Vertical Application)

WIDTH TO:	24"	30"	36"	42"	48"	54"	60"	66"	72"	78"	84"	96"	108"	120"	132"	144"	156"	168"
HEIGHT TO:																		
36"	\$301	327	356	381	406	433	460	485	511	538	561	610	656	700	739	784	846	909
42"	322	352	382	414	441	470	503	530	559	590	615	663	709	762	805	859	927	996
48"	343	375	411	444	475	506	539	576	603	633	665	717	764	834	874	929	1004	1079
54"	359	400	437	476	507	538	572	605	637	666	700	754	814	876	931	987	1066	1146
60"	381	423	465	506	538	572	609	643	678	712	744	810	874	940	995	1062	1147	1233
66"	403	446	490	537	575	609	645	686	719	759	794	864	932	1004	1066	1142	1234	1326
72"	426	471	521	568	607	642	679	729	763	802	843	922	991	1068	1138	1218	1316	1414
78"	447	497	549	594	635	669	712	762	797	843	882	966	1041	1121	1196	1280	1383	1486
84"	470	522	575	624	668	709	754	803	842	891	931	1022	1104	1188	1263	1358	1465	1575
90"	489	547	601	652	699	744	791	844	888	938	983	1077	1166	1255	1339	1431	1546	1661
96"	511	570	624	676	726	773	822	880	925	978	1022	1124	1212	1309	1402	1493	1612	1734
102"	532	593	652	704	754	807	863	919	972	1022	1070	1177	1276	1371	1468	1569	1695	1822
108"	554	616	677	733	788	840	903	964	1015	1072	1121	1234	1337	1439	1540	1647	1780	1913
114"	575	639	702	763	818	875	940	1002	1061	1119	1169	1293	1399	1506	1617	1720	1857	1997
120"	594	665	734	815	874	932	1001	1070	1127	1191	1236	1364	1476	1589	1700	1811	1956	2103

Note: See "Configuration Specifications" charts for any size restrictions.

GROUP B-SS (Vertical Application)

- SOFTSTYLE 3/4" BLACKOUT (S23)
- SOFTSTYLE SUBDUE 3/4" SINGLE CELL BLACKOUT (S61)

WIDTH TO:	24"	30"	36"	42"	48"	54"	60"	66"	72"	78"	84"	96"	108"	120"	132"	144"	156"	168"
HEIGHT TO:																		
36"	\$354	382	419	448	477	507	541	570	602	633	660	715	772	822	867	921	994	1068
42"	377	413	449	486	519	552	589	624	657	693	723	779	834	895	946	1010	1090	1172
48"	401	439	483	522	555	595	635	678	708	744	781	843	899	979	1026	1093	1180	1269
54"	423	469	512	558	596	633	671	712	749	784	822	886	958	1031	1095	1161	1254	1348
60"	447	497	547	594	633	671	715	755	796	837	875	950	1027	1104	1171	1250	1349	1450
66"	476	525	576	632	675	715	759	807	845	894	932	1017	1097	1181	1254	1342	1449	1558
72"	501	554	611	668	713	754	798	857	896	943	991	1083	1164	1255	1338	1431	1546	1661
78"	526	583	644	697	747	788	837	895	939	992	1035	1134	1222	1320	1406	1505	1625	1747
84"	552	613	677	734	785	834	884	944	990	1048	1095	1200	1299	1397	1487	1595	1723	1852
90"	575	642	706	764	821	874	929	993	1044	1101	1154	1266	1369	1475	1573	1682	1817	1954
96"	601	669	733	794	853	909	967	1032	1088	1151	1202	1321	1427	1541	1647	1757	1896	2038
102"	625	697	764	825	885	948	1014	1079	1143	1203	1257	1385	1499	1613	1725	1846	1993	2143
108"	652	726	795	861	925	988	1062	1132	1194	1260	1320	1451	1570	1693	1812	1937	2093	2249
114"	676	753	823	896	962	1029	1104	1180	1247	1316	1373	1518	1645	1770	1903	2024	2186	2351
120"	697	781	854	928	1006	1086	1176	1256	1325	1399	1453	1604	1737	1868	2000	2129	2298	2472

Note: See "Configuration Specifications" charts for any size restrictions.

OPTIONS: NO EXTRA CHARGE

- Vertical Application – Left or Right stack location

VERTICAL APPLICATION STACK DESIGN SURCHARGES

- Center Opening – Price as two separate shades.
- Center Stacking.....add \$60 each

NOTE: Stack is 6-1/2" when fully open regardless of ordered width

Center Opening (Split Stack)

Price as two separate units, left and right

Center Stack

Add surcharge

2" HYBRID PLEAT SEMI-OPAQUE (Vertical Application)

• 2" HYBRID PLEAT – SEMI-OPAQUE (HPF)

WIDTH TO:	24"	30"	36"	42"	48"	54"	60"	66"	72"	84"	96"	108"	120"	132"	144"	156"	168"
HEIGHT TO:																	
36"	\$351	419	420	444	460	491	509	595	618	661	693	808	911	1002	1092	1190	1278
42"	396	426	436	457	479	504	527	615	639	688	719	828	937	1030	1124	1224	1317
48"	416	440	447	483	527	533	551	656	672	724	762	873	1002	1102	1202	1310	1408
54"	431	466	470	504	547	550	571	677	700	748	784	906	1024	1127	1229	1339	1438
60"	434	480	481	527	568	570	591	697	721	779	820	947	1070	1177	1283	1398	1503
66"	466	509	511	540	568	582	603	721	740	795	847	975	1102	1213	1322	1441	1549
72"	477	531	531	563	579	611	633	760	775	847	897	1024	1160	1275	1390	1516	1629
78"	551	603	613	639	663	694	721	757	778	843	901	1035	1167	1285	1400	1525	1641
84"	567	619	631	659	688	721	747	784	811	877	941	1080	1213	1333	1454	1586	1703
90"	587	642	644	673	701	741	774	811	840	906	976	1119	1258	1383	1508	1644	1767
96"	599	659	663	691	719	764	794	831	865	935	1003	1150	1299	1429	1556	1698	1824
108"	663	739	741	777	815	862	914	956	997	1084	1172	1340	1506	1657	1806	1967	2116
120"	711	800	830	873	917	973	1026	1083	1132	1227	1330	1518	1699	1869	2037	2221	2387

2" HYBRID PLEAT BLACKOUT (Vertical Application)

• 2" HYBRID PLEAT – BLACKOUT (HPR)

WIDTH TO:	24"	30"	36"	42"	48"	54"	60"	66"	72"	84"	96"	108"	120"	132"	144"	156"	168"
HEIGHT TO:																	
36"	\$399	425	429	454	470	501	519	608	630	676	706	825	929	1021	1113	1213	1304
42"	407	437	443	466	488	515	535	632	653	701	732	846	958	1054	1149	1252	1346
48"	423	451	457	490	548	553	561	669	686	739	777	889	1022	1125	1224	1336	1435
54"	438	478	477	516	564	561	580	691	713	764	801	928	1046	1151	1255	1367	1469
60"	443	488	490	535	598	585	602	712	737	795	833	964	1088	1197	1304	1423	1529
66"	473	520	520	549	601	597	617	739	755	814	862	994	1123	1235	1346	1466	1576
72"	488	542	543	571	611	621	643	775	790	863	912	1044	1181	1299	1415	1543	1659
78"	564	615	623	651	676	710	736	772	795	860	918	1055	1187	1306	1424	1552	1668
84"	612	671	685	717	750	790	823	863	895	973	1044	1196	1342	1477	1608	1754	1885
90"	672	740	746	781	815	861	898	943	977	1059	1140	1308	1470	1618	1763	1922	2066
96"	738	828	843	888	933	994	1042	1099	1147	1251	1350	1543	1737	1911	2084	2271	2441
108"	803	918	937	997	1055	1125	1202	1265	1327	1456	1587	1806	2024	2227	2426	2645	2843
120"	852	990	1048	1121	1188	1274	1355	1436	1513	1653	1809	2057	2292	2521	2749	2996	3220

OPTIONS: NO EXTRA CHARGE

- Vertical Application – Left or Right stack location

VERTICAL APPLICATION STACK DESIGN SURCHARGES

- Center Opening – Price as two separate shades.
- Center Stacking.....add \$60 each

NOTE: Stack is 6-1/2" when fully open regardless of ordered width

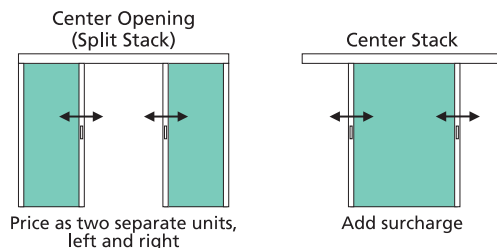

VERTICAL APPLICATION CONFIGURATION SPECIFICATIONS

NOTE: Use metal tape measure for all measurements. Measures to 1/8 inch.

- Fits rectangular window and door openings
- Opens and closes from side to side; ideal for sliding glass doors & French doors

Four fabric stacking options:

- 1) left stack
- 2) right stack
- 3) center opening ("split stack")
- 4) center stack

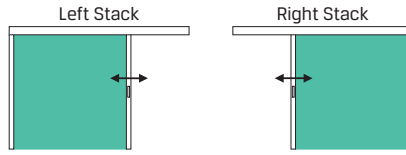

Top Rail Dimensions

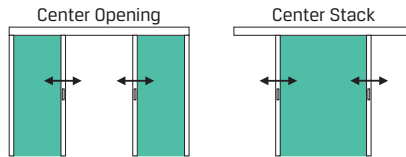
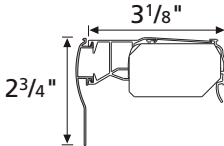

	VERTICAL APPLICATION – SIZE STANDARDS		
	Cellular		2" Hybrid Pleat
	Large Single Cell Semi-Opaque Fabrics	Large Single Cell Blackout Fabrics	Semi-Opaque & Blackout
Min. Width	12"	12"	12"
Max. Width Side & Center Stack	168"	168"	168"
Max. Width Split Stack	190"	190"	190"
Min. Height	24"	24"	24"
Max. Height	120"	120"	120"
Max Sq. ft. Side & Center Stack	120	120	100
Max Sq. ft. Split Stack	140	140	120

NOTE: Vertical Application **not available** with any Small Single or Double Cell Cellular fabric

Vertical Application not available with 9/16" Single or Double Cell fabrics.

NOTE: Stack is 6-1/2" space per side when fully opened, regardless of shade width.

FINISHED DIMENSIONS

Adjustments are taken from ordered dimensions.

	SoftStyle	2" Hybrid Pleat
Inside (IB) Mount		
Headrail unit	- 3/16"	- 3/16"
Shade height	- 1/2"	- 1/2"
Valance width (non-flush)	+ 1-1/4"	+ 1-1/4"
Valance width (flush)	- 1/8"	- 1/8"
Outside (OB) Mount		
Headrail unit	- 3/16"	- 3/16"
Shade height	ordered height	ordered height
Valance width	+ 1"	+ 1"
Standard Returns		
Outside Mount	3-1/8"	4-1/4"
Inside Non Flush Mount*	1-1/2"	1-1/2"

NOTE: Measurements may vary ± 1/8"

MOUNTING REQUIREMENTS

Use a metal tape measure for all measurements.

	SoftStyle	2" Hybrid Pleat
Inside (IB) Mount		
Minimum mounting depth	15/16"	15/16"
Minimum mounting depth, flush mount:	3-5/8"	4-1/2"
Outside (OB) Mount		
Minimum flat vertical surface	5/8"	5/8"

*For each spacer block, 1/2" will be added to the length of the valance returns. For extension brackets, 2" will be added unless otherwise specified.

COLOR-COORDINATED HARDWARE

- Hardware colors are currently limited to 10. Refer to the Hardware Color Guide for colors and more information.

EXCLUSIONS

- All 9/16" Single and Double Cell fabrics.

VERTICAL APPLICATION ORDERING NOTES

- Specify inside (IB), outside (OB), inside non flush mount, or flush mount.
- Specify stacking configuration – left stack, right stack, center opening, or center stack. On split stack shades, both panels will be of equal width, unless otherwise specified. Center stacks are a surcharge option.
- Inside non flush mount valance returns are 1-1/2" if returns are selected*
- Standard handle height is 40" to 50" from bottom of moving rail; specify any desired variation from this standard.
- Standard installation hardware (brackets) provided.

- Specify no-charge installation hardware:
 - Spacer blocks
 - Extension brackets
 - Shims (OB)
- Also refer to vertical application measuring in "General Information" section.

NOTE: Cut-outs can be done on movable and stationary rail. 1" is the only cut-out width available for Vertical Application shades. 6" is the maximum cut-out height and the height is measured from the floor to the top of the desired cut-out location.

Cut-outs are not available on 2" Hybrid Pleat.

- SOFTSTYLE 9/16" SEMI-OPAQUE (S11)
- SOFTSTYLE 3/4" BEGINNINGS SEMI-OPAQUE (S50)
- SOFTSTYLE 3/4" SEMI-OPAQUE (S21)

CLASSIC SKYLIGHT A-SS

WIDTH TO:	24"	30"	36"	42"	48"	54"	60"	66"	72"
HEIGHT TO:									
36"	\$192	217	243	274	296	328	351	379	403
42"	202	232	264	293	324	352	381	406	432
48"	213	248	277	311	351	379	415	445	468
54"	227	265	299	334	378	401	445	476	504
60"	235	279	317	355	410	437	478		
66"	249	296	337	379	431	461	501		
72"	259	310	355	399	449	484	531		

Prices in the 66" and 72" columns apply to side stack

↖ Skylight with Simplicity Motorization Maximum Width: 48"

CLASSIC SKYLIGHT B-SS

- SOFTSTYLE BEGINNINGS DOUBLE CELL SEMI-OPAQUE (S51)
- SOFTSTYLE DOUBLE CELL SEMI-OPAQUE (S31)

WIDTH TO:	24"	30"	36"	42"	48"	54"	60"	66"	72"
HEIGHT TO:									
36"	\$225	256	286	321	347	382	413	446	471
42"	236	271	309	344	379	414	448	478	507
48"	250	290	328	366	413	445	486	523	552
54"	268	310	351	391	444	469	523	559	593
60"	276	329	373	418	480	511	561		
66"	292	347	396	446	504	542	590		
72"	306	364	418	469	528	568	625		

Prices in the 66" and 72" columns apply to side stack

↖ Skylight with Simplicity Motorization Maximum Width: 48"

OPTIONS: EXTRA CHARGE	
• Classic Skylight Extension Pole (extends 5' to 10')	\$39

STANDARD SIMPLICITY SURCHARGE AND OPTIONS EXTRA CHARGE – SPECIFY ON ORDER USE APPROPRIATE ARCH GRID FOR SHADE PRICE, THEN ADD EXTRA CHARGE(S) BELOW.	
• Standard Simplicity Motorization (Battery wand included in the price)	add \$274 per shade
– 5 Channel Remote Control (Black Part #CS5138 or White Part #CS5138W)	add \$46 each
– 14 Channel TD/BU Remote – Available in White Only (Part #CS52136)	add \$69 each
– 48" Extension Wire (Part #CS5133Z)	add \$8 each
– DC Power Supply (Part #CS5151)	add \$38 each

SIMPLICITY RECHARGEABLE MOTORIZATION SURCHARGE AND OPTIONS EXTRA CHARGE – SPECIFY ON ORDER USE APPROPRIATE ARCH GRID FOR SHADE PRICE, THEN ADD EXTRA CHARGE(S) BELOW.	
• Simplicity Rechargeable Motorization	add \$274 per shade
– 5 Channel Remote Control (Black Part #CS5138 or White Part #CS5138W)	add \$46 each
– 14 Channel TD/BU Remote – Available in White Only (Part #CS52136)	add \$69 each
– 48" Extension Wire (Part #CS5133Z)	add \$8 each
– Solar Panel (Part #CS52096)	add \$166 each
– Plug-In Charger (Part #CS5199)	add \$35 each

- SOFTSTYLE 9/16" BLACKOUT (S13)
- SOFTSTYLE SUBDUE 3/4" SINGLE CELL BLACKOUT (S61)
- SOFTSTYLE 3/4" BLACKOUT (S23)
- SOFTSTYLE DOUBLE CELL BLACKOUT (S32)

CLASSIC SKYLIGHT C-SS

WIDTH TO:	24"	30"	36"	42"	48"	54"	60"	66"	72"
HEIGHT TO:									
36"	\$235	271	303	337	369	405	438	467	494
42"	252	287	327	364	404	440	476	508	539
48"	263	308	348	389	437	469	513	550	582
54"	285	329	375	415	475	497	553	593	630
60"	295	349	395	442	505	543	595		
66"	310	366	416	469	534	574	633		
72"	328	389	440	497	566	608	664		

Prices in the 66" and 72" columns apply to side stack

↖ Skylight with Simplicity Motorization Maximum Width: 48"

OPTIONS: EXTRA CHARGE

- Classic Skylight Extension Pole (extends 5' to 10')\$39

**STANDARD SIMPLICITY SURCHARGE AND OPTIONS
EXTRA CHARGE – SPECIFY ON ORDER
USE APPROPRIATE ARCH GRID FOR SHADE PRICE, THEN ADD EXTRA CHARGE(S) BELOW.**

- **Standard Simplicity Motorization** (Battery wand included in the price)add \$274 per shade
 - 5 Channel Remote Control (Black Part #CS5138 or White Part #CS5138W).....add \$46 each
 - 14 Channel TD/BU Remote – Available in White Only (Part #CS52136).....add \$69 each
 - 48" Extension Wire (Part #CS5133Z)add \$8 each
 - DC Power Supply (Part #CS5151).....add \$38 each

**SIMPLICITY RECHARGEABLE MOTORIZATION SURCHARGE AND OPTIONS
EXTRA CHARGE – SPECIFY ON ORDER
USE APPROPRIATE ARCH GRID FOR SHADE PRICE, THEN ADD EXTRA CHARGE(S) BELOW.**

- **Simplicity Rechargeable Motorization**add \$274 per shade
 - 5 Channel Remote Control (Black Part #CS5138 or White Part #CS5138W).....add \$46 each
 - 14 Channel TD/BU Remote – Available in White Only (Part #CS52136).....add \$69 each
 - 48" Extension Wire (Part #CS5133Z)add \$8 each
 - Solar Panel (Part #CS52096)add \$166 each
 - Plug-In Charger (Part #CS5199).....add \$35 each

CLASSIC SKYLIGHT CONFIGURATION SPECIFICATIONS

NOTE: Use metal tape measure for all measurements. Measures to 1/8 inch.

CLASSIC SKYLIGHT

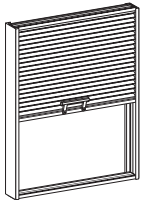

This easy to operate system holds shades in place. Perfect for skylights and other windows beyond reach.



- Hardware color: Aspen White (785)
- Manually operated with handle
- Ends of headrail, moving rail and anchor rail are enclosed by side tracks
- Features 2-cell fabric gasket attached to headrail; eliminates light leakage when shade is closed
- 5' adjustable extension pole – extends to 10'

CLASSIC SKYLIGHT – SIZE STANDARDS	
	SoftStyle
	All Fabrics
Min. Width	18"
Max. Width	60"
Min. Height	12"
Max. Height	72"
Max Area (sq. ft.)	25

* Classic Skylight not available with any 2" Hybrid Pleat fabrics

NOTE: Shades over 36" wide require support cords.
Rail stiffener is required when shade is over 42" wide.

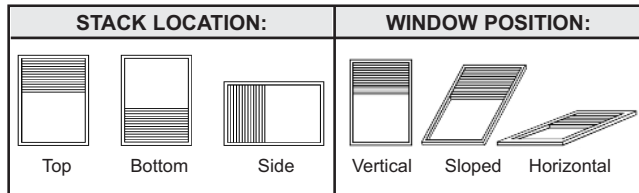

Note: Pleats will have a vertical orientation when side stack is ordered.

CLASSIC SKYLIGHT SIDE STACK – SIZE STANDARDS	
	SoftStyle
	All Fabrics
Min. Width	12"
Max. Width	72"
Min. Height	18"
Max. Height	60"
Max Area (sq. ft.)	25

* Classic Skylight not available with any 2" Hybrid Pleat fabrics

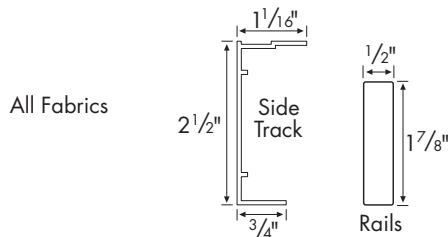

FINISHED DIMENSIONS

Adjustments are taken from ordered dimensions.

Inside (IB) Mount	
Headrail unit	- 3/16"
Shade height	ordered height
Fabric width	- 3/4"
Outside (OB) Mount	
Headrail unit	+ 3/4"
Shade height	ordered height
Fabric width	ordered width

NOTE: Measurements may vary ± 1/8"

NOTE: All finished dimensions include side tracks.

MOUNTING REQUIREMENTS

Use a metal tape measure for all measurements.

Inside (IB) Mount	
Minimum mounting depth IB:	1-1/4"
Minimum mounting depth, flush mount:	2-1/2"
Outside (OB) Mount	
Minimum flat vertical surface	1"

SKYLIGHT WITH SIMPLICITY MOTORIZATION CONFIGURATION SPECIFICATIONS

NOTE: Use metal tape measure for all measurements. Measures to 1/8 inch.

SKYLIGHT WITH SIMPLICITY MOTORIZATION



NOTE:

This is a different Skylight system than the Classic Skylight. Key differences include:

- Headrail and Bottomrail are identical and are the same rail used on standard shades with Simplicity Motorization
- Only available with fabric stack at the bottom of the window



Features

- Inside Mount only
- White Tiara (661) aluminum head and bottom rails. White vinyl side rails
- Use radio frequency controlled Simplicity motors
- The Simplicity wireless remote control operates individual or groups of shades

Operation & Installation Tips

- Shades installed into windows with metal casings may have a reduced radio frequency range, or may not operate at all
- Do not let the antenna on the motor touch any metal objects. This may interfere with signals from the remote control.
- Make sure to leave the top of the headrail open (motor exposed), do not cover; especially with metal materials. This could result in a reduced radio frequency range for the remote control or the shade may not operate at all.
- Skylights with Simplicity Motorization will NOT operate properly if installed in a completely horizontal application. The minimum recommended slope is 5%.

SKYLIGHT with SIMPLICITY MOTORIZATION - SIZE STANDARDS	
	All Cellular Fabrics
Minimum Width	18"
Maximum Width	48"
Minimum Height	12"
Maximum Height	72"

NOTE: Skylight with Simplicity Motorization is **not available** with 2" Hybrid Pleat Fabrics

NOTE: Size Standards are the same for Skylight with standard Simplicity and Rechargeable Simplicity

FINISHED DIMENSIONS

Adjustments are taken from ordered dimensions.

Inside (IB) Mount	
Headrail unit	- 3/16"
Shade height	ordered height
Fabric width	- 1-1/4"

NOTE: Measurements may vary $\pm 1/8"$

HEADRAIL & BOTTOMRAIL DIMENSIONS

Depth of Rail	2"
Depth of Rail & Bracket	2-1/4"
Depth of Rail, Side Tracks & Bracket	2-1/2"
Height of Rail	1-1/2"

NOTE: Skylight with Simplicity Motorization is available with standard Simplicity Motorization or Simplicity Rechargeable Motorization.

NOT AVAILABLE with PowerWand.

MOUNTING REQUIREMENTS

Use a metal tape measure for all measurements.

- Should not be more than 1/2" out of square to perform as intended
- The widest width of the window cannot exceed the narrowest width of the window by more than 3/8"
- The shade must be mounted with the fabric stack at the bottom or the lowest point in the window

Standard Motorization

Inside (IB) Mounts	
Minimum mounting depth, IB	2-1/2"

Rechargeable Motorization

Inside (IB) Mounts	
Minimum mounting depth, IB	
Over 20" wide	2-1/2"
Under 20" wide	3"

NOTE:

Skylight shades with Rechargeable Motorization **over 20" wide** feature an internal battery with charging port. Skylight shades with Rechargeable Motorization **under 20" wide** require an external battery pack which accounts for the additional mounting depth

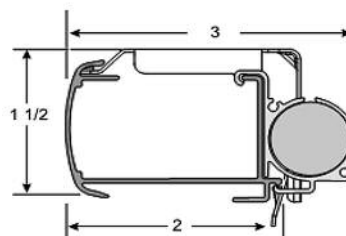

- SOFTSTYLE 9/16" SEMI-OPAQUE (S11)
- SOFTSTYLE 3/4" BEGINNINGS SEMI-OPAQUE (S50)
- SOFTSTYLE 3/4" SEMI-OPAQUE (S21)

ARCH A-SS

WIDTH TO:	24"	30"	36"	42"	48"	54"	60"	66"	72"	78"	84"
Stationary	\$80	91	104	122	141	160	184	211	237	270	306
Movable	116	133	152	174	198	228	257	292	328	376	431

ARCH B-SS

- SOFTSTYLE BEGINNINGS DOUBLE CELL SEMI-OPAQUE (S51)
- SOFTSTYLE DOUBLE CELL SEMI-OPAQUE (S31)

WIDTH TO:	24"	30"	36"	42"	48"	54"	60"	66"	72"	78"	84"
Stationary	\$92	106	122	144	163	189	216	247	278	316	357
Movable	135	155	177	203	233	268	302	343	383	441	505

ARCH C-SS

- SOFTSTYLE 9/16" BLACKOUT (S13)
- SOFTSTYLE 3/4" BLACKOUT (S23)
- SOFTSTYLE SUBDUE 3/4" SINGLE CELL BLACKOUT (S61)
- SOFTSTYLE DOUBLE CELL BLACKOUT (S32)

WIDTH TO:	24"	30"	36"	42"	48"	54"	60"	66"	72"	78"	84"
Stationary	\$109	125	144	166	193	222	254	289	328	373	419
Movable	158	183	207	238	273	314	355	403	449	519	594

OPTIONS: EXTRA CHARGE

- Top-Down Movable Arch Extension Pole (extends 5' to 10')\$39
- Arch and Elliptical Arch – price using width on Arch price charts for fabric desired.
- Rectangular Shade and Arch – price as 2 separate shades; One Arch and One Rectangular.

SPECIALTY SIZE STANDARDS & MEASURING INFORMATION

NOTE: Use metal tape measure for all measurements. Measures to 1/8 inch.

ARCHES

Refer to "Extra Charge Options" for Surcharge and Price Information

INSIDE MOUNT

Locate shape below.
Width: Measure exact width(s)
Height: Measure exact height(s)

OUTSIDE MOUNT

Locate shape below.
Width: Measure desired width(s)
Height: Measure desired height(s)

FAN-FOLD ARCHES

NON-MOVABLE ARCH (PERFECT ARCH = EXACT 1/2 CIRCLE, TEMPLATE REQUIRED)

FAN-FOLD STATIONARY PERFECT ARCH

Must be perfect arch.



Come standard with arch disc

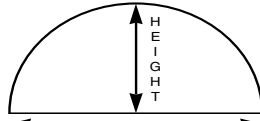

Width (Diameter)

SIZE STANDARDS

	SoftStyle
	All Fabrics
Min. Width	12"
Max. Width	84"
Min. Height	12"
Max. Height	42"

Not available with 2" Hybrid Pleat



MOVABLE ARCH (PERFECT ARCH = EXACT 1/2 CIRCLE, TEMPLATE REQUIRED)

FAN-FOLD OPERABLE PERFECT ARCH

Must be perfect arch. Specify L or R arch orientation when ordering.

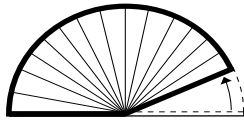

Shown Here – Fan Fold Left

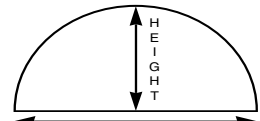

Width (Diameter)

SIZE STANDARDS

	SoftStyle
	All Fabrics
Min. Width	12"
Max. Width	84"
Min. Height	12"
Max. Height	42"

Not available with 2" Hybrid Pleat



Note: all fan-fold arches require the use of small, clear clips to be installed around the outer edge, which holds the fabric in place. The fabric must be slid out of the clips before the arch can be operated.

NON-MOVABLE ELLIPTICAL ARCH (TEMPLATE REQUIRED)

FAN-FOLD STATIONARY ELLIPTICAL ARCH

Non-perfect arch.

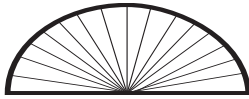

Come standard with arch disc

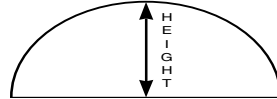

Width (Diameter)

SIZE STANDARDS

	SoftStyle
	All Fabrics
Min. Width	12"
Max. Width	84"
Min. Height	1/4 of width
Max. Height	1/2 of width

Not available with 2" Hybrid Pleat

Max height of straight sides is 10". Heights must be at least 25% of total width after the straight sides.



TOP-DOWN MOVABLE ARCH (TEMPLATE REQUIRED)

TOP-DOWN OPERABLE PERFECT ARCH

Must be perfect arch. (Template required)

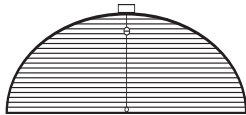

Fabric Pleats Oriented Horizontally.

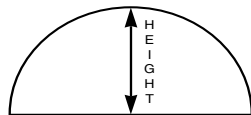

Width (Diameter)

SIZE STANDARDS

	SoftStyle
	All Fabrics
Min. Width	18"
Max. Width	84"
Min. Height	6"
Max. Height	48"

Not available with 2" Hybrid Pleat

Straight Side Specifications

- * If arch width is wider than 66", the max height=48"
- * If arch width is wider than 72", the max height=48"
- * Non-perfect arch: heights must be at least 25% of total width



Optional Top-Down Movable Arch Extension Pole
Extends 5' to 10' (Part #400037-0007)

Available as Inside (IB) Mount ONLY

Specify arch trim at order entry:
661 Tiara White
320 Rich Cream

TOP-DOWN OPERABLE ELLIPTICAL ARCH

Non-perfect arch. (Template required)

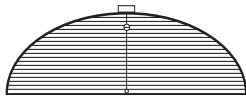

Fabric Pleats Oriented Horizontally.

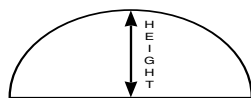

Width (Diameter)

SIZE STANDARDS

	SoftStyle
	All Fabrics
Min. Width	18"
Max. Width	84"
Min. Arch Height	1/4 width
Max. Height	48"

Not available with 2" Hybrid Pleat

Top-down arches will have a "flared" look to them when lowered. This is a natural characteristic of this product.

Arch trim kit included with Top-Down arches - available in White Tiara (661) & Rich Cream (320) - See the hardware guides for color example.

SPECIALTY SIZE STANDARDS & MEASURING INFORMATION

NOTE: Use metal tape measure for all measurements. Measures to 1/8 inch.

CIRCLES, QUARTER CIRCLES & ANGLE CUTS (TEMPLATE REQUIRED)

Refer to "Extra Charge Options" for Surcharge and Price Information

INSIDE MOUNT

Locate shape of window.
 Width: Measure exact width(s)
 Height: Measure exact height(s)
 Diagonal: Measure height of diagonal(s) (for Angle Cuts)

OUTSIDE MOUNT

Locate shape of window.
 Width: Measure desired width(s)
 Height: Measure desired height(s)
 Diagonal: Measure length of diagonal(s) (for Angle Cuts)

CIRCLES & QUARTER CIRCLE (TEMPLATE REQUIRED)

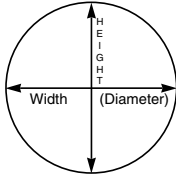

SIZE STANDARDS	
	All Fabrics
Min. Width (diameter)	12"
Max. Width (diameter)	42"
Min. Height	N/A
Max. Height	N/A

Not available with 2" Hybrid Pleat

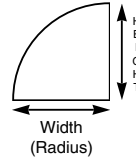

SIZE STANDARDS	
	All Fabrics
Min. Width	12"
Max. Width	42"
Min. Height	N/A
Max. Height	N/A

Not available with 2" Hybrid Pleat

ANGLE CUTS (TEMPLATE REQUIRED)

ANGLED TOP (TEMPLATE REQUIRED)

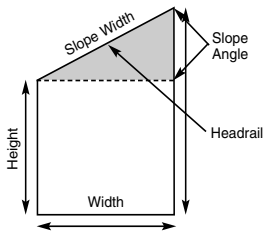

- Shades will raise to the shaded area indicated.
- Cordlock must always be at the lower end of the headrail

	SoftStyle Semi-Opaque Fabrics	SoftStyle Small Single Cell Blackout	SoftStyle Large Single Cell Blackout	SoftStyle Double Cell Blackout Fabric
--	-------------------------------	--------------------------------------	--------------------------------------	---------------------------------------

Maximum Height	84	72	72	84
Maximum Area (sq ft)	48	48	48	48

MINIMUM SLOPE WIDTH

0 - 30 Angle	12	12	12	12
30 - 45 Angle	14	14	14	14
45 - 60 Angle	N/A	17	N/A	

MAXIMUM SLOPE WIDTH

0 - 30 Angle	55	83	60	60
30 - 45 Angle	67	84	60	60
45 - 60 Angle	N/A	84	N/A	

Minimum Width	12	12	12	12
Maximum width				

0 - 30 Angle	48	70	48	48
30 - 45 Angle	48	60	48	48
45 - 60 Angle	N/A	42	N/A	

HEXAGON & OCTAGON (TEMPLATE REQUIRED)

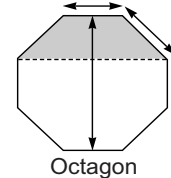
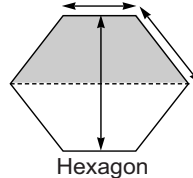

SIZE STANDARDS	
	All Fabrics*
Min. Width	8"
Max. Width	30"
Min. Height	8"
Max. Height	30"

*Not available with 2" Hybrid Pleat

- Minimum width and minimum height – 8"
- Maximum width and maximum height – 30"
- Operate from bottom to top or top to bottom
- Inside mounts will raise to the shaded area indicated above

TRAPEZOID (ALL PATTERNS) (TEMPLATE REQUIRED)

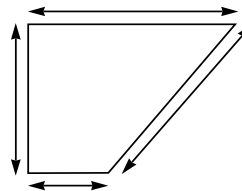

SIZE STANDARDS	
	All Fabrics*
Min. Width	8"
Max. Width	72"
Min. Height	9"
Max. Height	96"

*Not available with 2" Hybrid Pleat

- Minimum width – 8"
- Maximum width of long rail – 72"
- Maximum reduction for short rail – 9" per side
- Maximum height – 96"
- Maximum area (sq. ft.) – 40
- Opens in the direction of the longest rail (Top-Down or Bottom-Up)

OPTIONS: EXTRA CHARGE

- **Angle Cut**add \$199
(includes Angle Top, Hexagon, Octagon & Trapezoid)
- **Circle** – price as (width price x 1.3) using the Stationary Arch price chart for the fabric desired. Use exact width desired when ordering. (Template required.)
- **Quarter Circle** – price as (width price x 1.3) using the Stationary Arch price chart for the fabric desired. Use exact width desired when ordering.

SPECIALTY SIZE STANDARDS & MEASURING INFORMATION

NOTE: Use metal tape measure for all measurements. Measures to 1/8 inch.

ARCHES & QUARTER CIRCLES

FINISHED DIMENSIONS	
Adjustments are taken from ordered dimensions.	
Inside (IB) Mount	
Rail unit	- 3/16"
Arch height	ordered height
Fabric width	- 3/8"
Outside (OB) Mount	
Rail unit	+ 3/16"
Arch height	ordered height
Fabric width	ordered width
Max width for end mount is 36"	
NOTE: Measurements may vary \pm 1/8"	

MOUNTING REQUIREMENTS	
Use a metal tape measure for all measurements.	
Inside (IB) Mount	
Minimum mounting depth:	
Standard installation bracket	1-1/4"
Swivel bracket	1/2"
Minimum mounting depth, flush mount:	
Standard installation bracket	2-1/4"
Swivel bracket	2"
End mount bracket	2"
Outside (OB) Mount	
Minimum flat vertical surface	1"

CIRCLES

FINISHED DIMENSIONS	
Adjustments are taken from ordered dimensions.	
Inside (IB) Mount	
Rail unit	- 1/16"
Arch height	- 3/32"
Fabric width	- 3/8"
Outside (OB) Mount	
Rail unit	+ 3/32"
Arch height	+ 1/32"
Fabric width	ordered width
NOTE: Measurements may vary \pm 1/8"	

MOUNTING REQUIREMENTS	
Use a metal tape measure for all measurements.	
Inside (IB) Mount	
Minimum mounting depth	1-7/8"
Outside (OB) Mount	
Minimum flat vertical surface	5/8"

ANGLES

FINISHED DIMENSIONS	
Finished dimensions vary depending on the degree of the angle.	
NOTE: Measurements may vary \pm 1/8"	

MOUNTING REQUIREMENTS	
SAME AS STANDARD CORDLOCK SHADES	

SPECIALTY SHAPES

FINISHED DIMENSIONS	
Adjustments are taken from ordered dimensions.	
Inside (IB) Mount	
Rail unit	- 3/16"
Arch height	ordered height
Fabric width	- 3/8"
Outside (OB) Mount	
Rail unit	+ 3/16"
Arch height	ordered height
Fabric width	ordered width
NOTE: Measurements may vary \pm 1/8"	

MOUNTING REQUIREMENTS	
SAME AS ARCHES & QUARTER CIRCLES	

CELLULAR SIZE STANDARDS SUMMARY BY CONFIGURATION & FABRIC

STANDARD 3/4" RAIL SYSTEM

CELLULAR			2" HYBRID PLEAT
All Semi- Opaque Fabrics	Subdue Blackout (S61)	All other Blackout Fabrics	All Fabrics

Standard Cordlock

Min Width (net) *	8"	8"	8"	N/A
Max Width	60"	60"	60"	
Max Width - End Mount	36"	36"	36"	
Min Height	12"	12"	12"	
Max Height	120"	120"	120"	
Max Area (Sq/Ft)	40-50	40	60	

Standard Cordlock - Top-Down

Min Width (net) *	10"	10"	10"	N/A
Max Width	60"	60"	60"	
Max Width - End Mount	36"	36"	36"	
Min Height	12"	12"	12"	
Max Height	96"	96"	96"	
Max Area (Sq/Ft)	40-50	40	60	

Standard Cordlock - Top-Down/ Bottom-Up

Min Width (net) *	10"	10"	10"	N/A
Max Width	72"	72"	72"	
Max Width - End Mount	36"	36"	36"	
Min Height	12"	12"	12"	
Max Height	96"	96"	96"	
Max Area (Sq/Ft)	40-50	40	60	

Standard Cordlock - Two-On-One Headrail

Min Width (per panel) (net) *	8"	8"	8"	N/A
Min Width (overall)	16"	16"	16"	
Max Width (per panel)	60"	60"	60"	
Max Width (overall)	120"	120"	120"	
Max Width - End Mount	36"	36"	36"	
Min Height	12"	12"	12"	
Max Height	120"	120"	120"	
Max Area (Sq/Ft)	40-50	40	60	

Continuous Cord Loop

Min Width (net)	18"	18"	18"	18"
Max Width	120"	120"	120"	120"
Max Width – End Mount	48"	48"	48"	42"
Min Height	12"	12"	12"	12"
Max Height	120"	120"	120"	120"
Max Area (Sq/Ft)	100	90	100	60

Continuous Cord Loop - Top-Down/Bottom-Up

Min Width (net)	24"	24"	24"	24"
Max Width	120"	120"	120"	120"
Max Width – End Mount	48"	48"	48"	42"
Min Height	12"	12"	12"	12"
Max Height	120"	120"	120"	120"
Max Area (Sq/Ft)	100	90	100	60

Continuous Cord Loop - Two-On-One Headrail

Min Width (per panel) (net)	18"	18"	18"	18"
Min Width (overall)	36"	36"	36"	36"
Max Width (per panel)	100"	96"	96"	102"
Max Width (overall)	120"	120"	120"	120"
Min Height	12"	12"	12"	12"
Max Height	120"	120"	120"	120"
Max Area (Sq/Ft)	83	80	80	60

CELLULAR SIZE STANDARDS SUMMARY BY CONFIGURATION & FABRIC

CELLULAR			2" HYBRID PLEAT
All Semi- Opaque Fabrics	Subdue Blackout (S61)	All other Blackout Fabrics	All Fabrics

Cordless Lift System

Min Width (net)	16"	16"	16"	16"
Max Width	120"	84"	96"	120"
Max Width - End Mount	48"	48"	48"	42"
Min Height	12"	12"	12"	12"
Max Height	84"	84"	84"	84"
Max Area (Sq/Ft)	70	49	56	60

Cordless Lift System - Top-Down/ Bottom-Up

Min Width (net)	16"	16"	16"	16"
Max Width	96"	84"	96"	120"
Max Width - End Mount	48"	48"	48"	42"
Min Height	12"	12"	12"	12"
Max Height	84"	84"	84"	84"
Max Area (Sq/Ft)	56	49	56	60

Cordless Lift - Two-On-One Headrail

Min Width (per panel) (net)	16"	16"	16"	16"
Min Width (overall)	32"	32"	32"	32"
Max Width (per panel)	100"	84"	100"	104"
Max Width (overall)	120"	120"	120"	120"
Min Height	12"	12"	12"	12"
Max Height	84"	84"	84"	84"
Max Area (per panel) (Sq/Ft)	70	49	56	60

Cordless Lift - Three-On-One Headrail

Min Width (per panel) (net)	16"	16"	16"	16"
Min Width (overall)	48"	48"	48"	48"
Max Width (per panel)	120"	120"	120"	120"
Max Width (overall)	174"	174"	174"	174"
Min Height	12"	12"	12"	12"
Max Height	84"	84"	84"	84"
Max Area (per panel) (Sq/Ft)	70	49	58	60

Cordless Lift & Lock

Min Width (net)	9-1/2"	9-1/2"	9-1/2"	9-1/2"
Max Width	84"	84"	84"	84"
Max Width - End Mount	48"	48"	48"	48"
Min Height	12"	12"	12"	12"
Max Height	84"	84"	84"	84"
Max Area (Sq/Ft)	49	49	49	49

Cordless Lift & Lock - Top-Down/ Bottom-Up

Min Width (net)	16"	16"	16"	16"
Max Width	84"	84"	84"	84"
Max Width - End Mount	48"	48"	48"	42"
Min Height	12"	12"	12"	12"
Max Height	84"	84"	84"	84"
Max Area (Sq/Ft)	49	49	49	49

Cordless Lift & Lock - Two-On-One Headrail

Min Width (per panel) (net)	9-1/2"	9-1/2"	9-1/2"	9-1/2"
Min Width (overall)	20"	20"	20"	20"
Max Width (per panel)	84"	84"	84"	84"
Max Width (overall)	168"	168"	168"	168"
Min Height	12"	12"	12"	12"
Max Height	84"	84"	84"	84"
Max Area (per panel) (Sq/Ft)	49	49	49	49

Cordless Lift & Lock - Three-On-One Headrail

Min Width (per panel) (net)	9-1/2"	9-1/2"	9-1/2"	9-1/2"
Min Width (overall)	30"	30"	30"	30"
Max Width (per panel)	84"	84"	84"	84"
Max Width (overall)	168"	168"	168"	168"
Min Height	12"	12"	12"	12"
Max Height	84"	84"	84"	84"
Max Area (per panel) (Sq/Ft)	49	49	49	49

CELLULAR SIZE STANDARDS SUMMARY BY CONFIGURATION & FABRIC

CELLULAR			2" HYBRID PLEAT
All Semi- Opaque Fabrics	Subdue Blackout (S61)	All other Blackout Fabrics	All Fabrics

TriLight Shades - Continuous Cord Loop

Min Width (net)	24"	24"	24"	24"
Max Width	83" - 96"	83"-96"	83" - 96"	83" - 96"
Max Width - End Mount	48"	48"	48"	42"
Min Height	12"	12"	12"	12"
Max Height	96"	96"	96"	96"
Max Area (Sq/Ft)	64	50	50	60

* The cellular fabric (bottom panel) max width can be reduced by the ordered PLE fabric (top panel), if PLE max width < cellular max width.

** Willa Sheer maximum width is 83"

TriLight Shades - Cordless

Min Width (net)	16"	16"	16"	16"
Max Width	83" - 96"	83"-96"	83" - 96"	83" - 96"
Max Width - End Mount	48"	48"	48"	42"
Min Height	12"	12"	12"	12"
Max Height	84"	84"	84"	84"
Max Area (Sq/Ft)	56	49	49	60

* The cellular fabric (bottom panel) max width can be reduced by the ordered PLE fabric (top panel), if PLE max width < cellular max width.

** Willa Sheer maximum width is 83"

TriLight Shades - Cordless Lift & Lock

Min Width (net)	12"	12"	12"	12"
Max Width	84"	84"	84"	84"
Max Width - End Mount	48"	48"	48"	42"
Min Height	12"	12"	12"	12"
Max Height	84"	84"	84"	84"
Max Area (Sq/Ft)	49	49	49	49

* The cellular fabric (bottom panel) max width can be reduced by the ordered PLE fabric (top panel), if PLE max width < cellular max width.

** Willa Sheer maximum width is 83"

Vertical Application

Min Width	12"	12"	12"	12"
Max Width Side & Center Stack	168"	168"	168"	168"
Max Width Split Stack	190"	144"	190"	190"
Min Height	24"	24"	24"	24"
Max Height	120"	120"	120"	120"
Max Area Side & Center Stack	120	120	100	100
Max Area Split Stack	140	120	140	120

CELLULAR SIZE STANDARDS SUMMARY BY CONFIGURATION & FABRIC

CELLULAR			2" HYBRID PLEAT
All Semi- Opaque Fabrics	Subdue Blackout (S61)	All other Blackout Fabrics	All Fabrics

Classic Skylight

Min Width	18"	18"	18"	N/A
Max Width	60"	60"	60"	
Min Height	12"	12"	12"	
Max Height	72"	72"	72"	
Max Area (Sq/Ft)	25	25	25	

Classic Skylight – Side Stack

Min Width	12"	12"	12"	N/A
Max Width	72"	72"	72"	
Min Height	18"	18"	18"	
Max Height	60"	60"	60"	
Max Area (Sq/Ft)	25	25	25	

Skylight with Simplicity Motorization

Min Width	18"	18"	18"	N/A
Max Width	48"	48"	48"	
Min Height	12"	12"	12"	
Max Height	72"	72"	72"	
Max Area (Sq/Ft)	N/A	N/A	N/A	

Non-Movable Perfect Arch (Fan-Fold)

Min Width	12"	12"	12"	N/A
Max Width	84"	84"	84"	
Min Height	12"	12"	12"	
Max Height	42"	42"	42"	

Movable Perfect Arch (Fan-Fold)

Min Width	12"	12"	12"	N/A
Max Width	84"	84"	84"	
Min Height	12"	12"	12"	
Max Height	42"	42"	42"	

Non-Movable Elliptical Arch (Fan-Fold)

Min Width	12"	12"	12"	N/A
Max Width	84"	84"	84"	
Min Height	1/4 width	1/4 width	1/4 width	
Max Height	42"	42"	42"	

Top-Down Movable Perfect Arch

Min Width	18"	18"	18"	N/A
Max Width	84"	84"	84"	
Min Height	6"	6"	6"	
Max Height	48"	42"	48"	

Top-Down Movable Elliptical Arch

Min Width	18"	18"	18"	N/A
Max Width	84"	84"	84"	
Min Height	1/4 width	1/4 width	1/4 width	
Max Height	48"	42"	48"	

Angle

Min Width	12	12	12	N/A
Max Width	angle chart	angle chart	angle chart	
Max Height	angle chart	angle chart	angle chart	
Max Area (Sq/Ft)	48	30	48	

PRODUCT COMPONENTS – STANDARD RECTANGULAR

3/8" End Mount Bracket (Part #2980038000) – Not Shown
 3/4" End Mount Bracket (Part #2980050000) – Not Shown

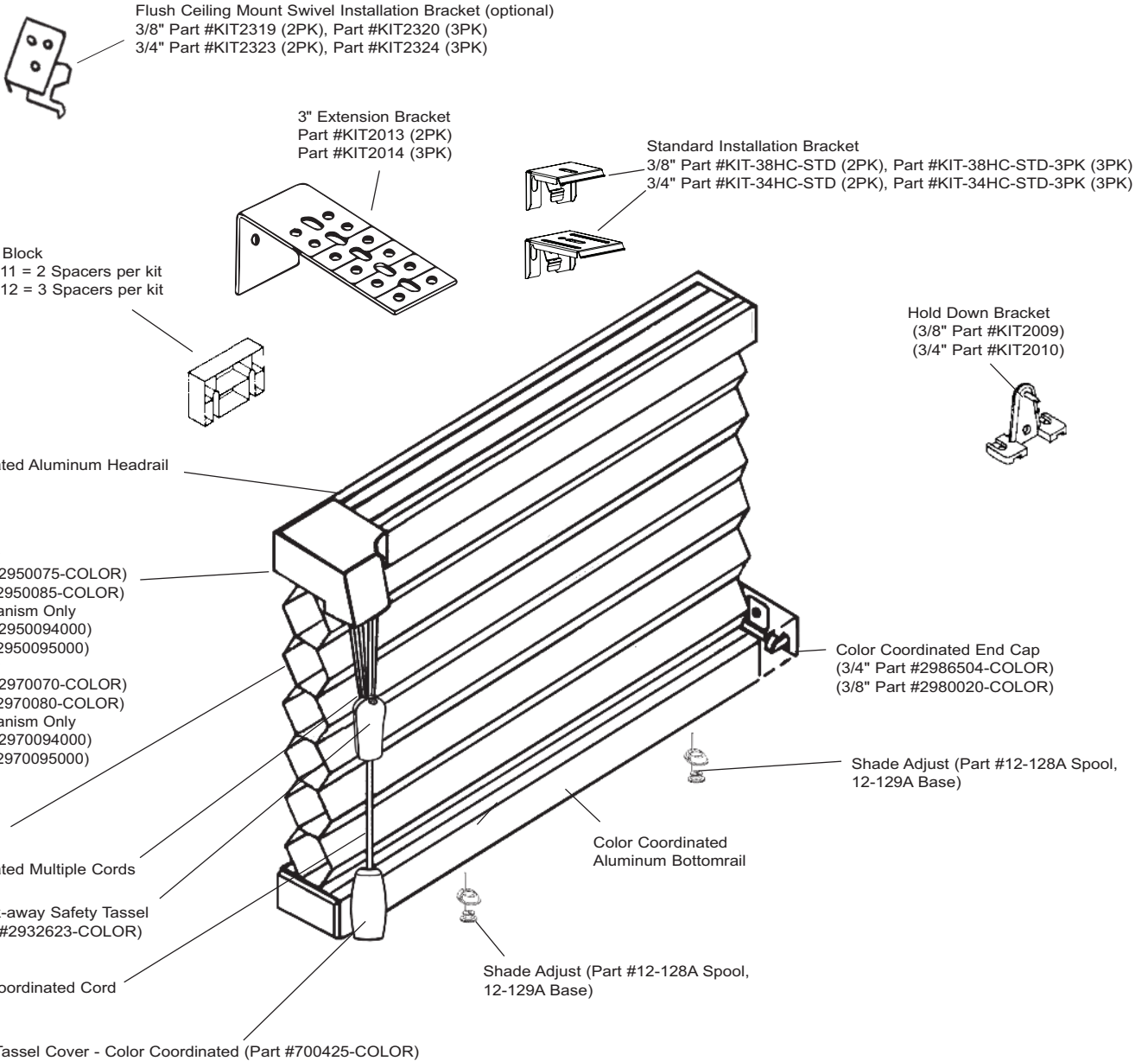

Arch Trim – White (Part #2280364661)
 – Rich Cream (Part #2280364320)

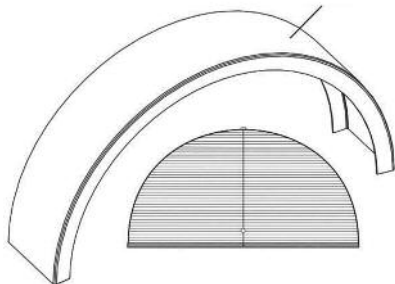

Child Safety Kit (Cord Cleat)
 (Part #KIT2728)

PRODUCT COMPONENTS – CORDLESS

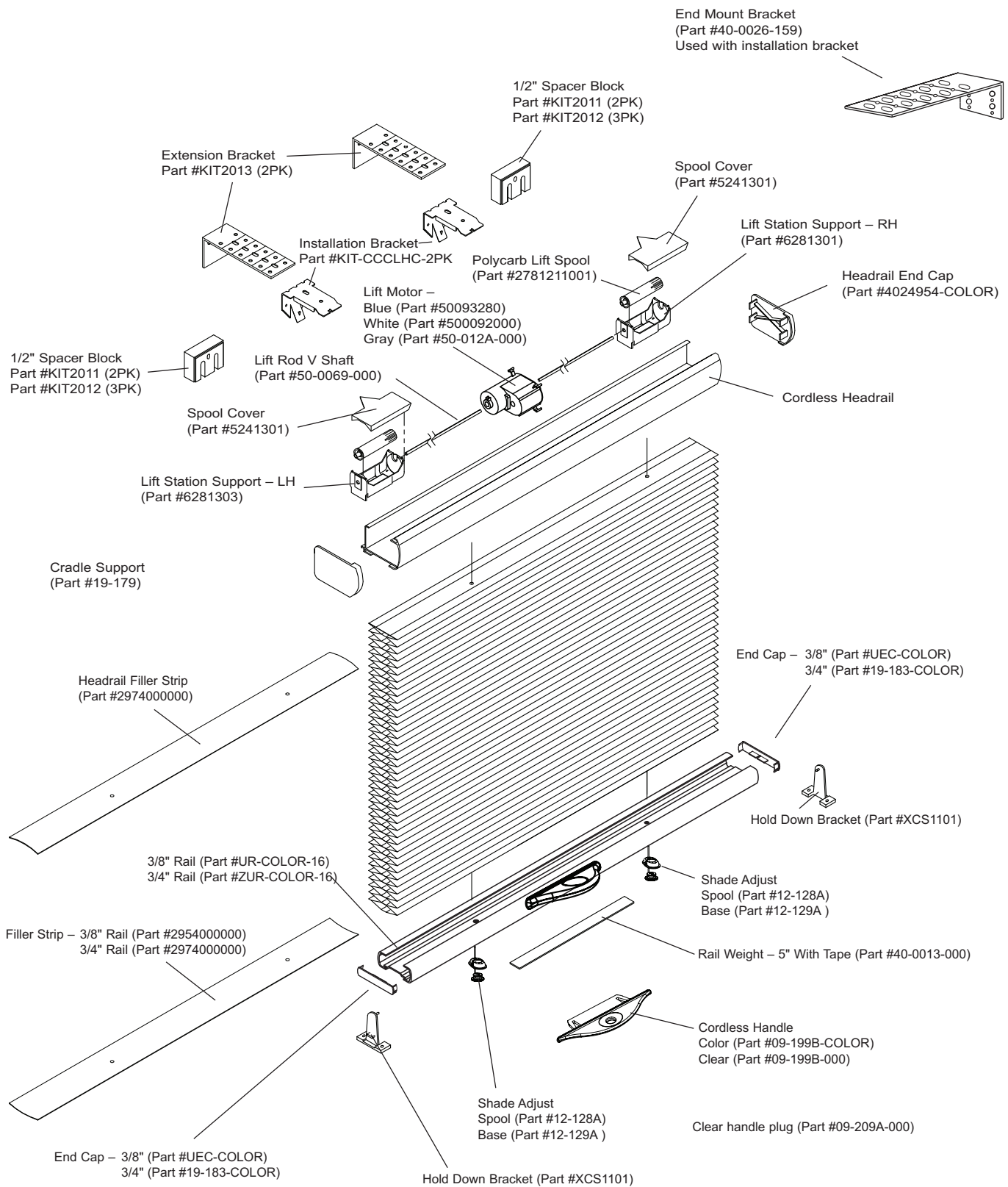

CORDLESS TOP-DOWN/BOTTOM-UP

Striker Plate:
Zinc: Part #CS5467PL-TDBU (Painted rails)
White: Part #CS5467PL-TDBU-W (Fabric covered rails)

Magnet:
Zinc: Part #CS5467 (Painted rails)
Magnet Cover - White: Part #CS5467CV-W (Fabric covered rails)
Magnet Lock: Part #CS5471
Magnet Screw: Part #CS5474

PRODUCT COMPONENTS – 2" HYBRID PLEAT

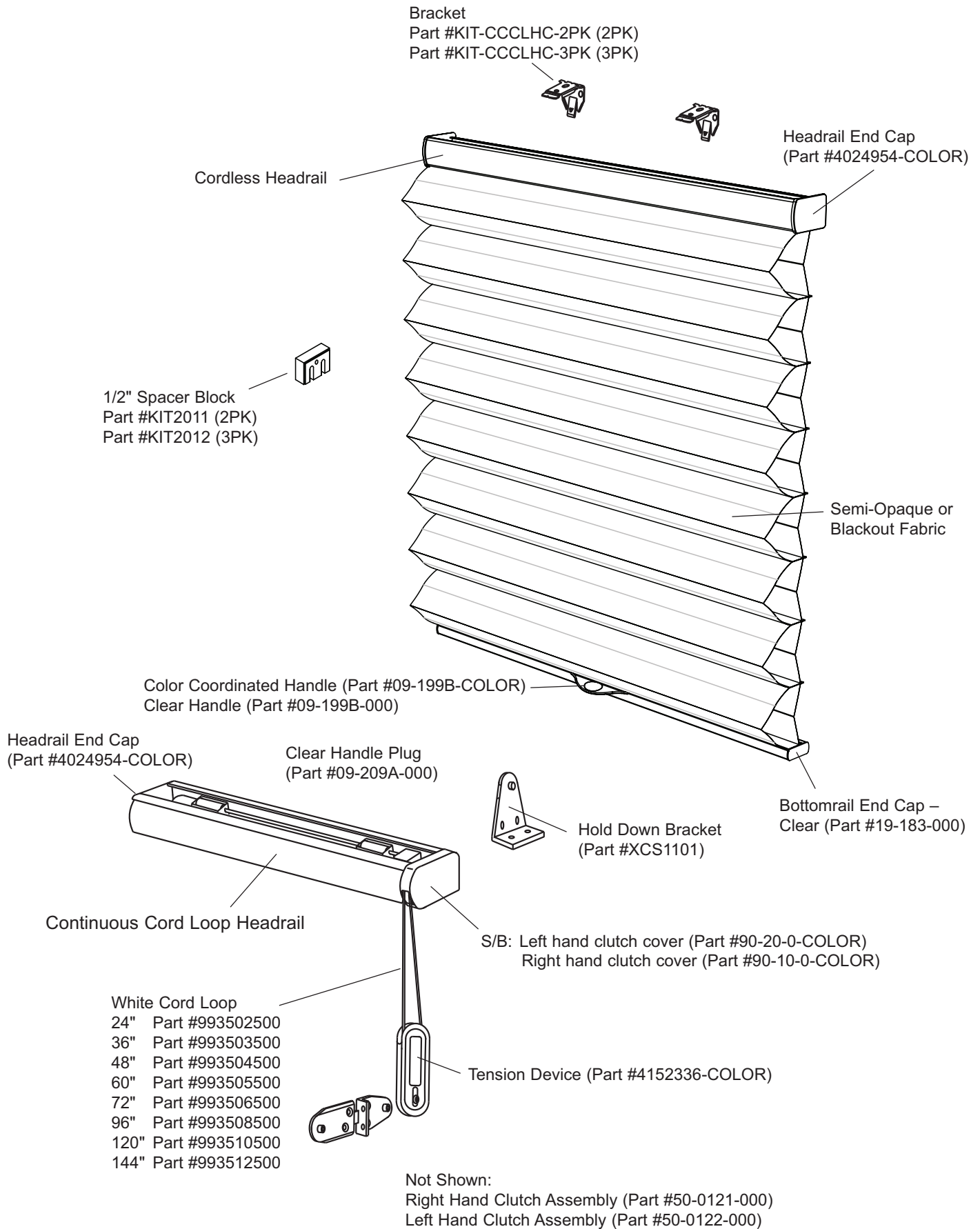

PRODUCT COMPONENTS – CORDLESS LIFT & LOCK

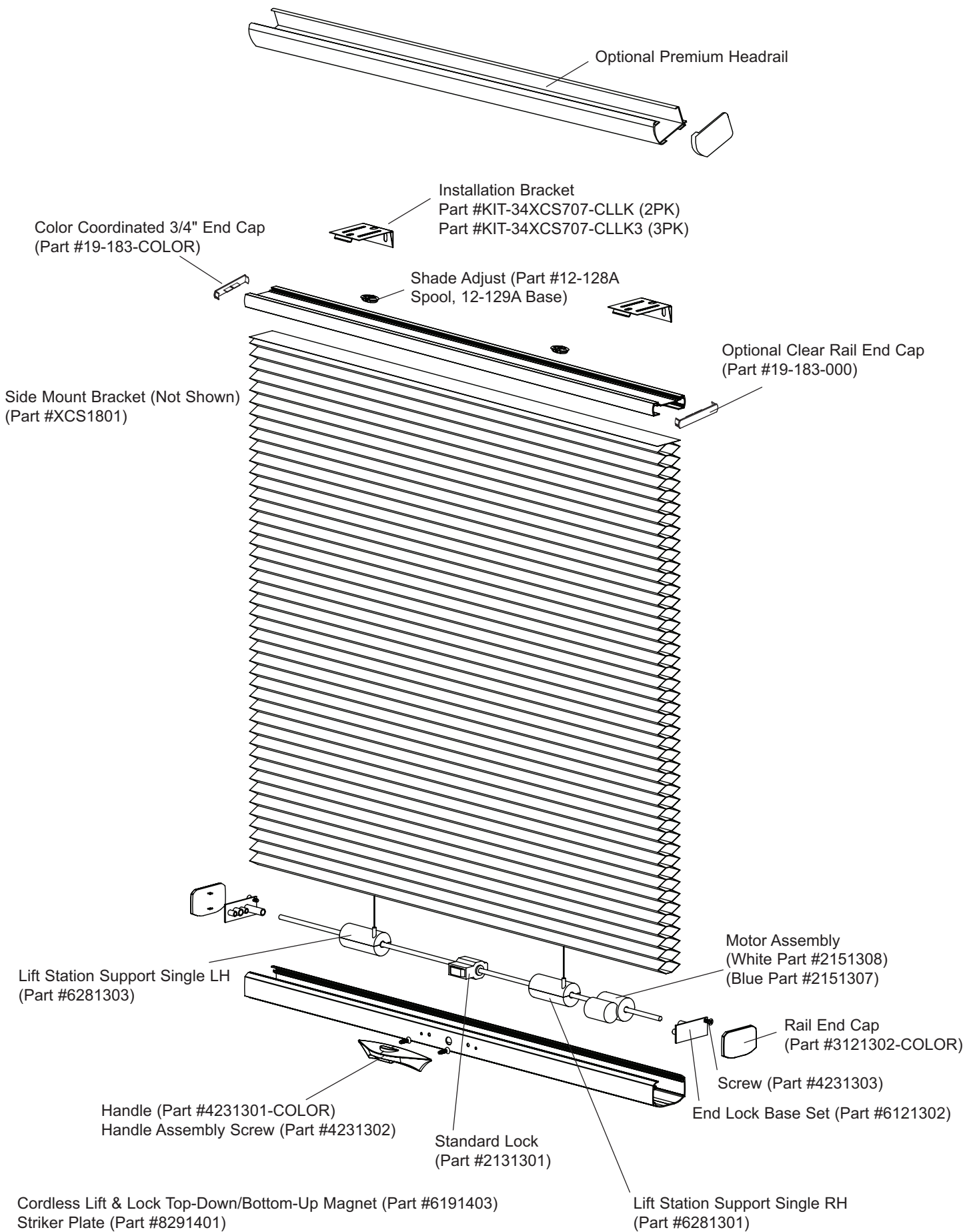

PRODUCT COMPONENTS – CONTINUOUS CORD

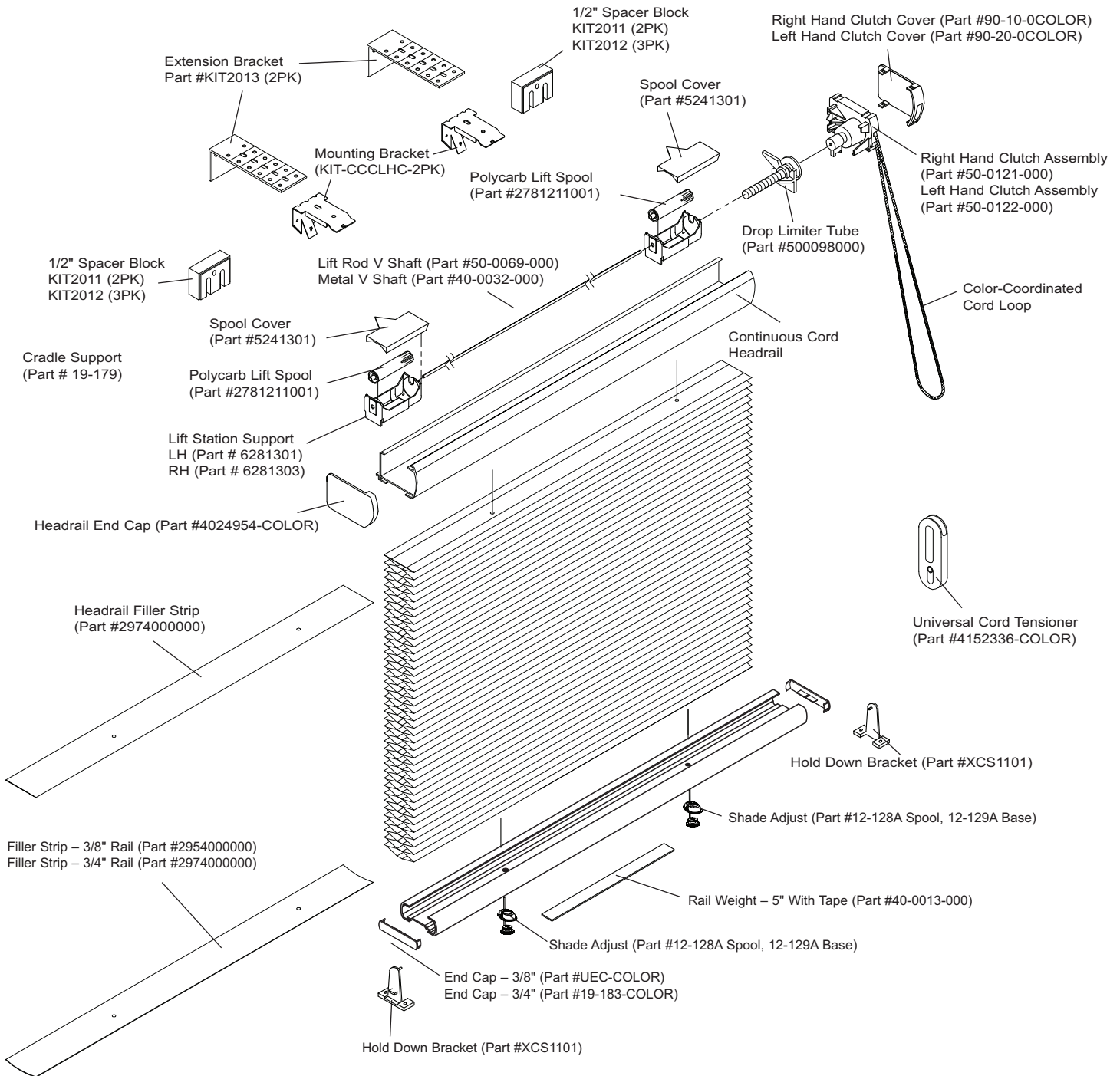

Universal Cord Tensioner Mounting Kit (Part #KIT2350)

Continuous Cord Top-Down/Bottom-Up Components

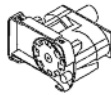

LH Rear Clutch Assembly (Part #CS4317)



Dual Bottom Limiter (Part #500199000)

TRILIGHT PRODUCT COMPONENTS – CORDLESS & CONTINUOUS CORD LOOP

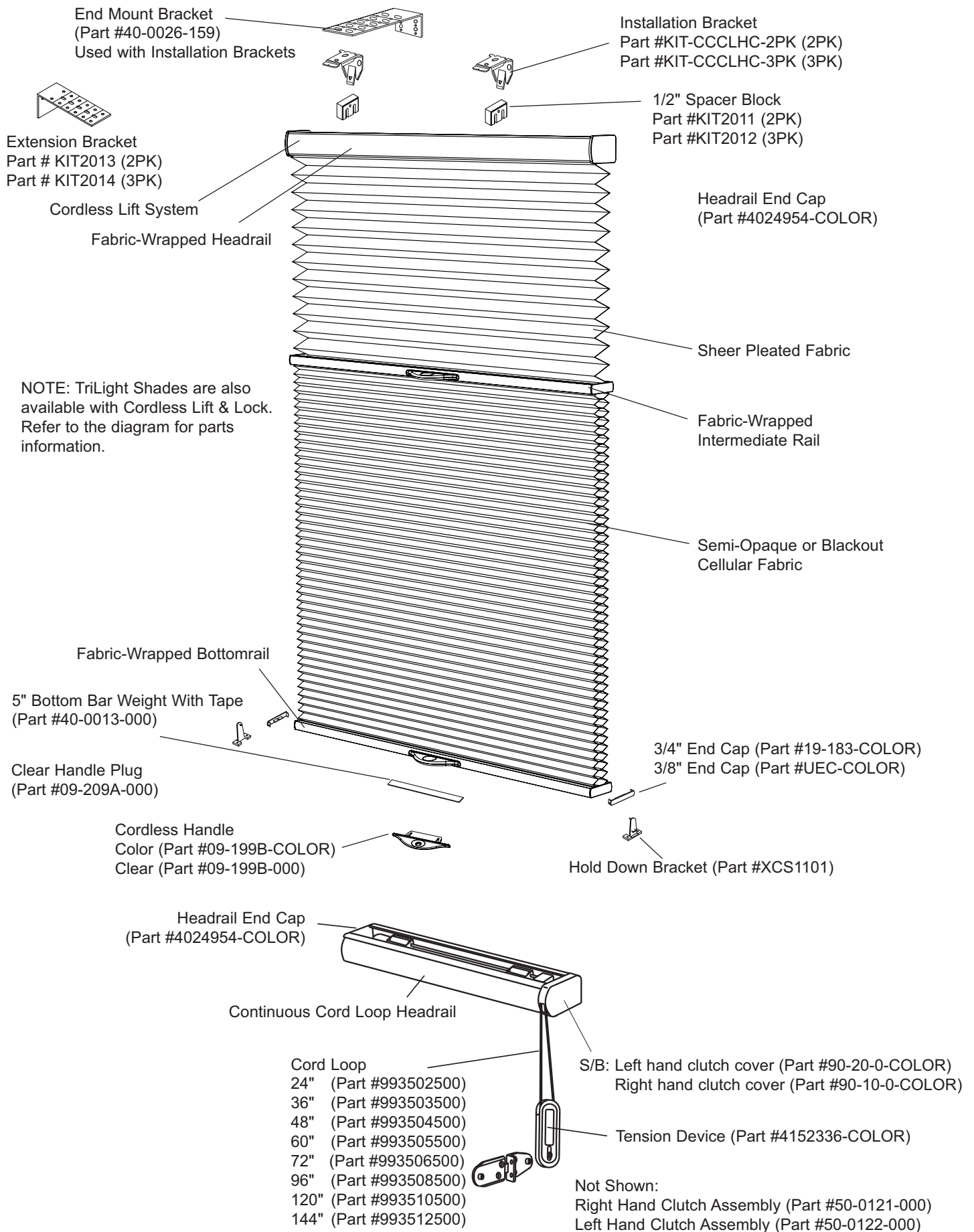

PRODUCT COMPONENTS – 2" HYBRID PLEAT TRILIGHT

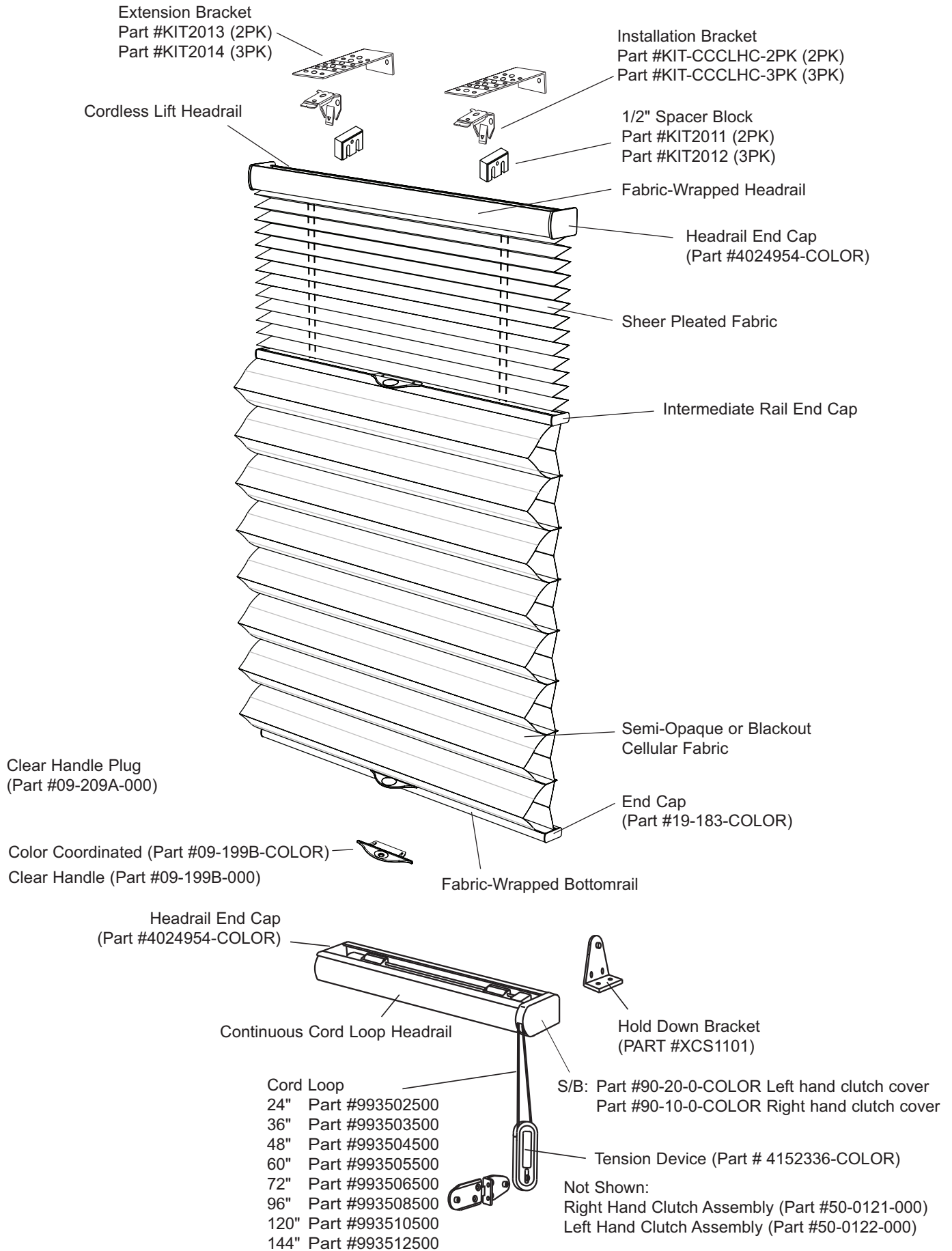

PRODUCT COMPONENTS – SIMPLICITY RECHARGEABLE MOTORIZATION

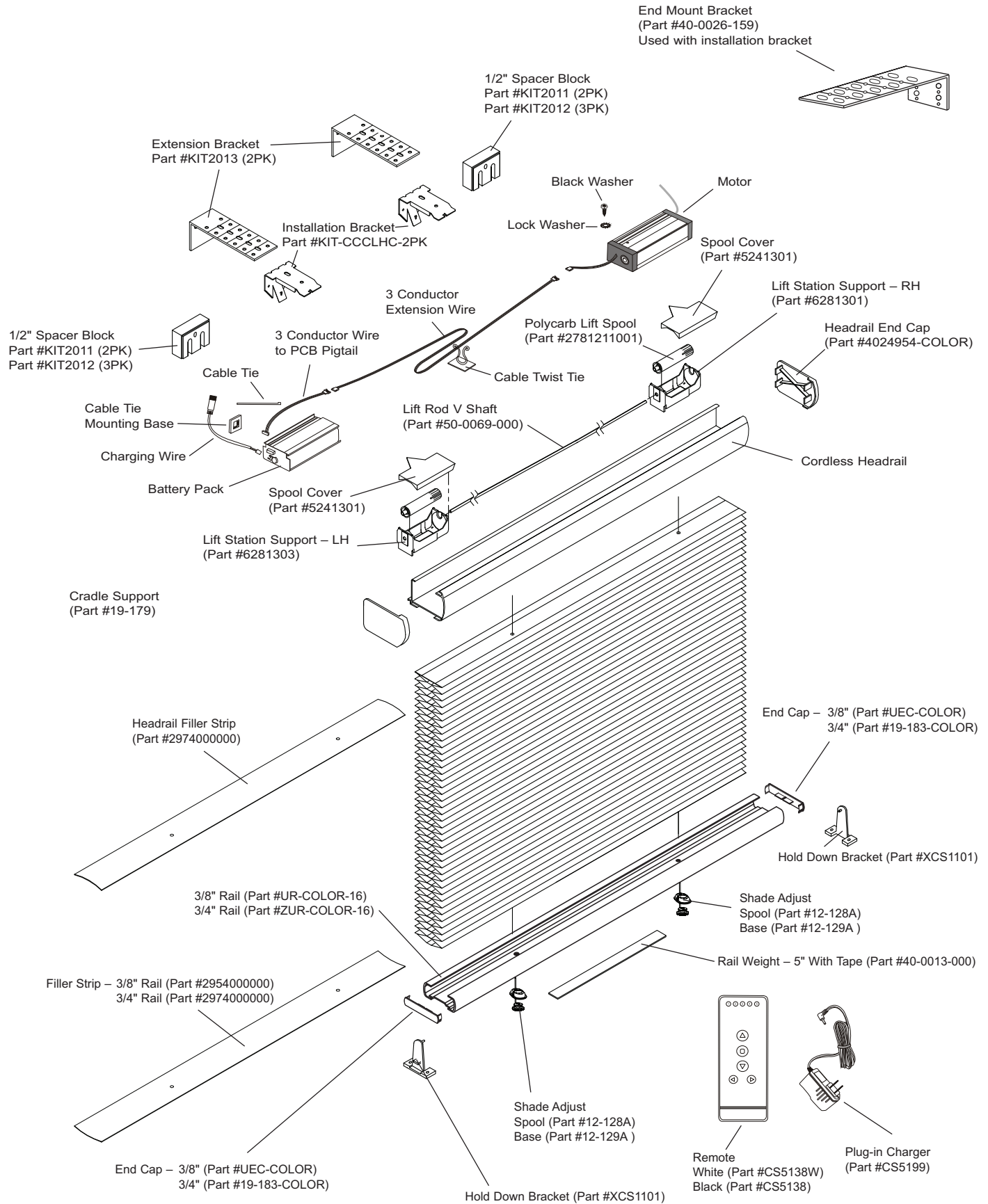

- Simplicity Top-Down/Bottom-Up Components**
- 14 Channel Remote (Part #CS52136)
 - Primary Motor (Part #CS52132)
 - Secondary Motor (Part #CS52133)
 - Internal Battery Pack (Part #CS52134)
 - Exterior Battery Pack (Part #CS52105)
 - 6 Conductor Extension Wire (Part #CS52122)

PRODUCT COMPONENTS – POWERWAND™ MOTORIZATION

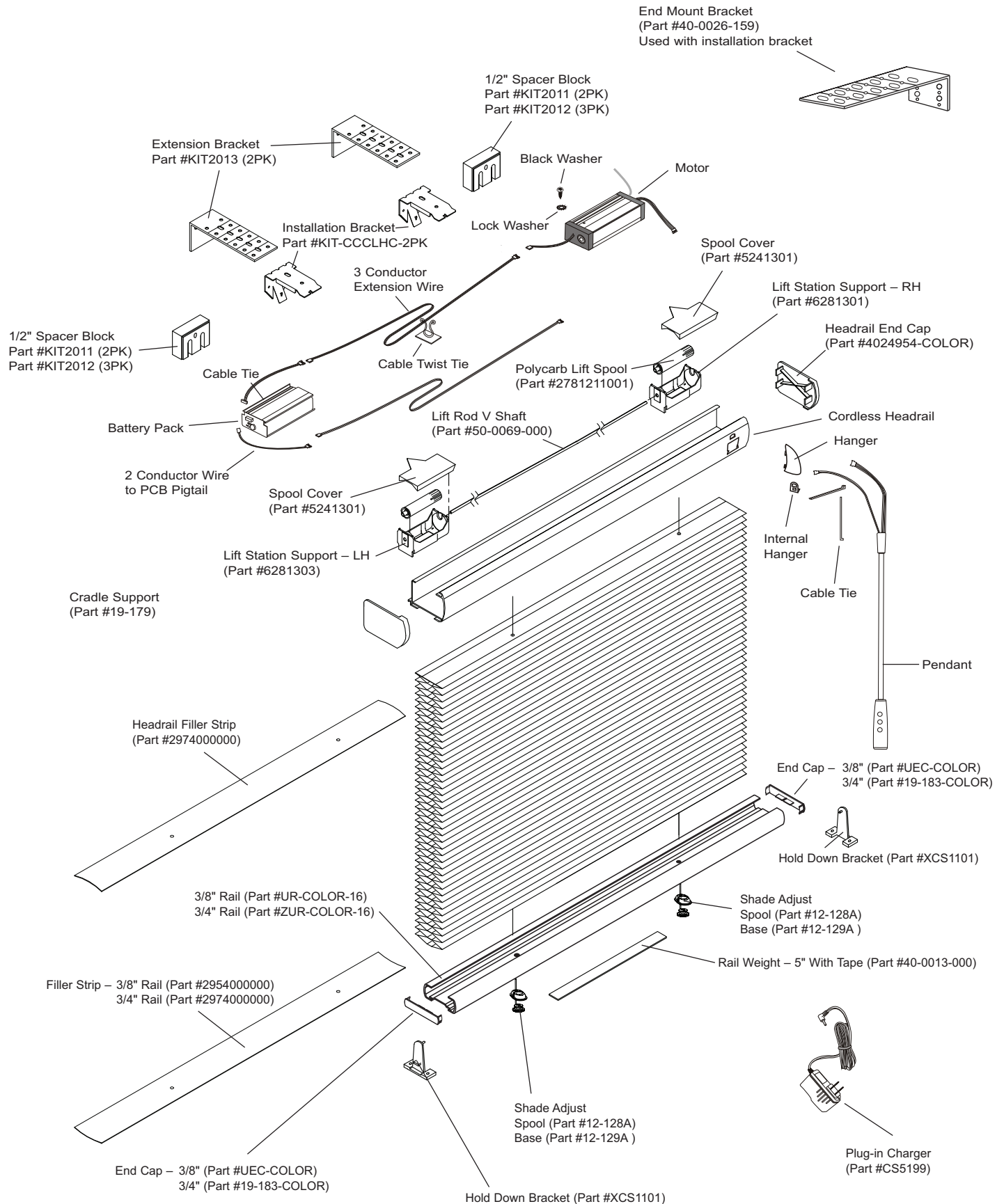

PRODUCT COMPONENTS – CELLULAR VERTICAL APPLICATION

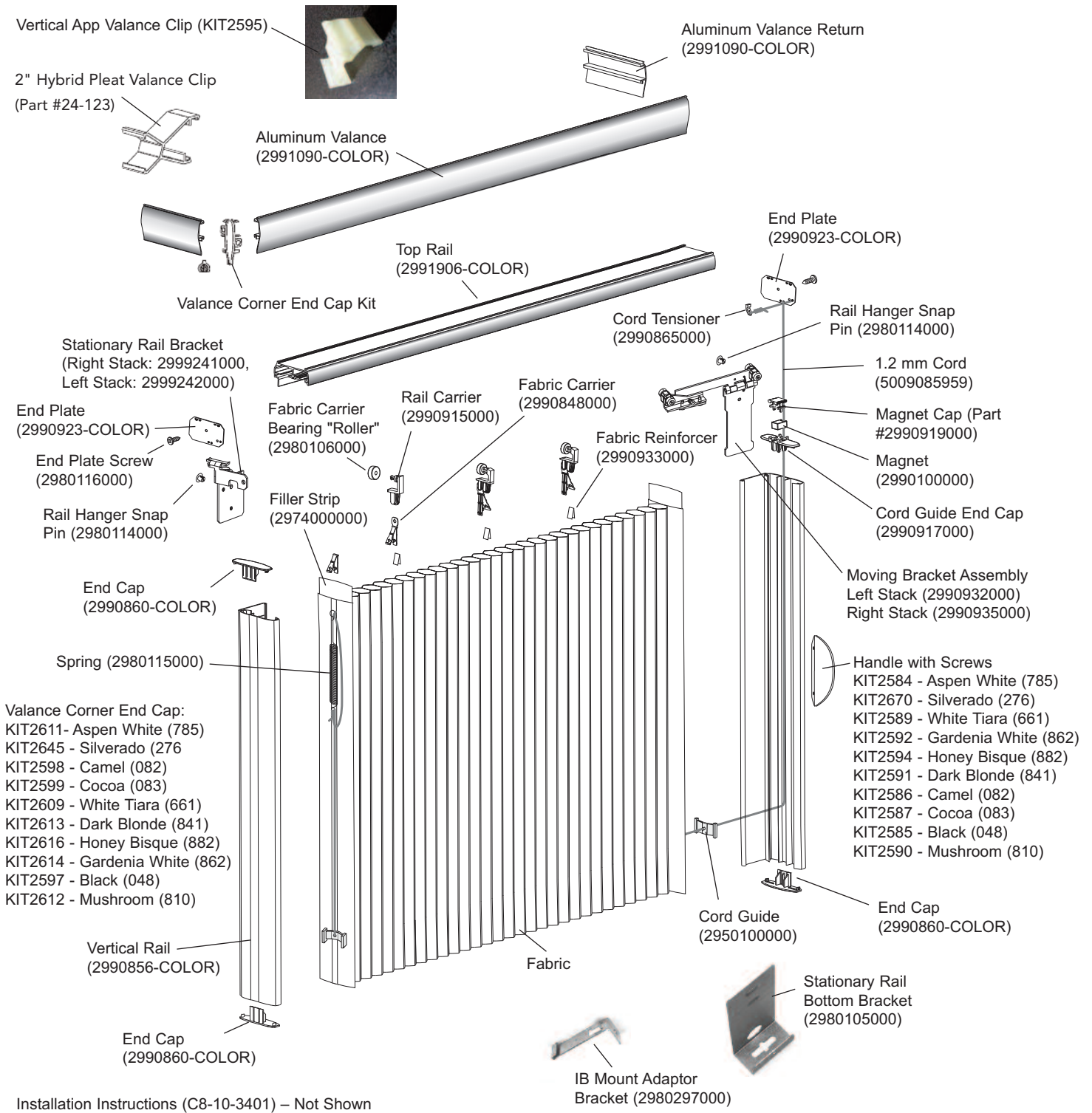

Installation Instructions (C8-10-3401) – Not Shown



White Magnetic Strip (split stack) (2990133000)



Extension Bracket (40-0026-159)



Installation Bracket with Screws (2990934000)



Mounting Screws #6 x 1.5 (2980153000)



Shim (2990938785)



1/2" Spacer Block KIT2011 = 2 Spacers/kit KIT2012 = 3 Spacers/kit

PRODUCT COMPONENTS – SKYLIGHT

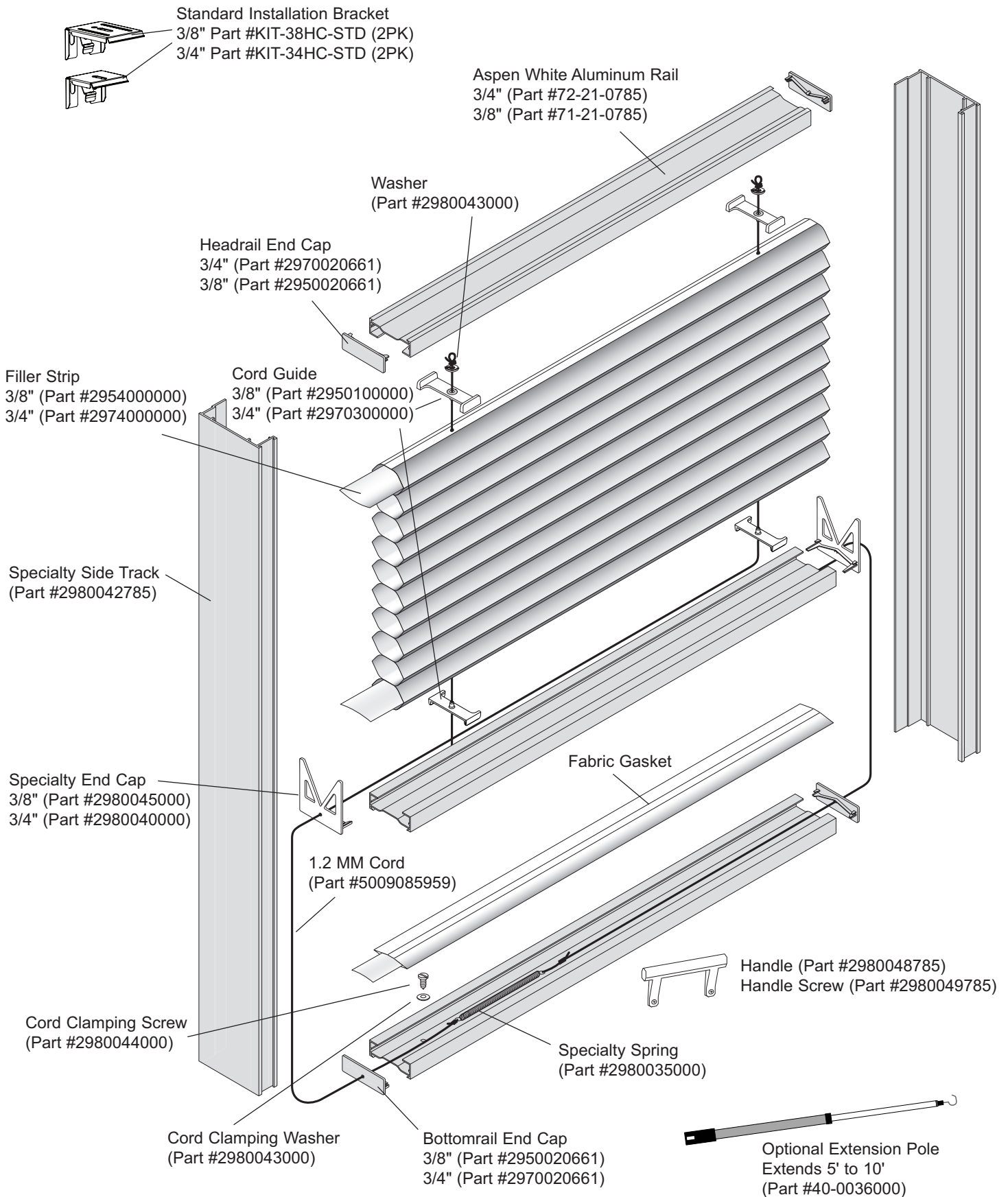

PRODUCT COMPONENTS – SIMPLICITY SKYLIGHT

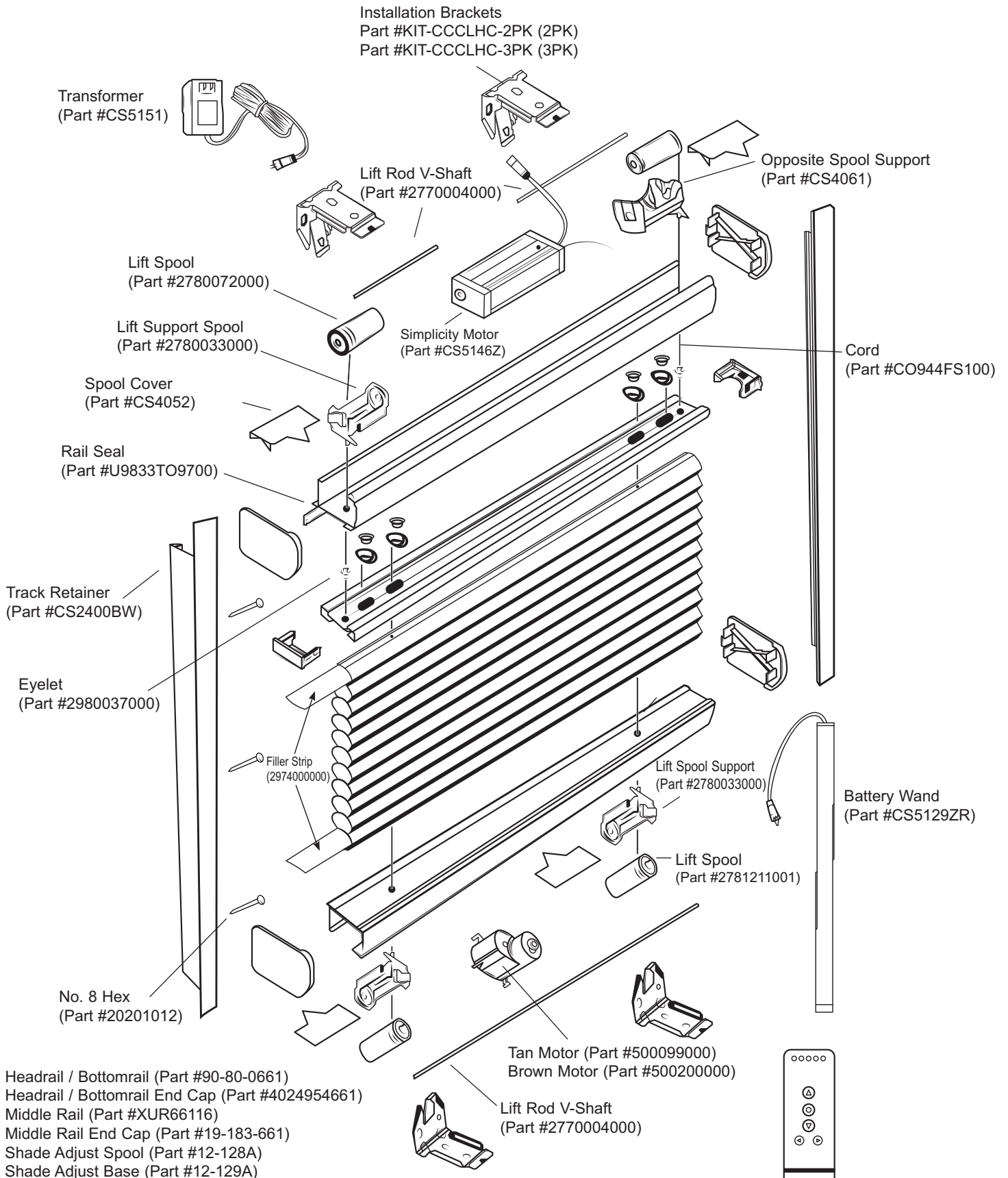

Rechargeable Motor Components

- Internal Battery Pack (Part #CS52101)
- Exterior Battery Pack (Part #CS52105)
- Plug-In Charger (Part #CS5199)
- Solar Charger (Part #CS52096)

- Simplicity Remote – 5 Channel
(Part #CS5138) – Black
(Part #CS5138W) – White

- Simplicity Remote – 14 Channel
(Part #CS52136)