

// Retail Price List & Product Info Guide

ALTA  
WINDOW FASHIONS

TEXTON



# HONEYCOMB

SHADES

Effective February 4, 2019

*design simplified™*

---

# TABLE OF CONTENTS

---

## Product Overview

• What's New for 2019 . . . . .	2
• Features & Benefits . . . . .	2
• Pattern Information . . . . .	3
• Fabric and Rail Color Charts . . . . .	4-8

## Pricing for Standard Rectangular, Options, RemoteLift 2.0, Simplicity Surcharges

• Price Groups 1-12 Honeycomb Fabrics . . . . .	9-20
• Price Group 13 – 2" Hybrid Pleat – Semi-Opaque . . . . .	21
• Price Group 14 – 2" Hybrid Pleat – Blackout . . . . .	22
• Motorization Surcharges and Options. . . . .	23

## Product Configuration Specifications

• Standard Cordlock . . . . .	24
• Two-on-One Headrail . . . . .	25
• Top-Down or Top-Down/Bottom-Up . . . . .	26
• Two-Fabric Combination . . . . .	27
• Cut-Outs . . . . .	27
• Cordless Lift . . . . .	28
• Cordless Lift & Lock . . . . .	29
• Continuous Cord Loop . . . . .	30-31

## Versatile Innovations™

### TriLight Shades®

• Features & Benefits . . . . .	32
• Selecting a TriLight Shade . . . . .	32
• Sheer Pleated Color Chart . . . . .	33
• Pricing Groups and Options . . . . .	34
• Configuration Specifications . . . . .	35-37
• Stacking Information . . . . .	35-37

## Product Configuration Specifications

• RemoteLift™ 2.0 Motorization . . . . .	38-42
• Simplicity and PowerWand™ . . . . .	43-48
• Vertical Application . . . . .	49-52
• Classic Skylight & Skylight with Simplicity Motorization . . . . .	53-56
• Arches . . . . .	57-58
• Specialty Shapes . . . . .	59-60
• Size Standards Summary . . . . .	61-64
• Product Components Diagrams. . . . .	65-76

### **Oversize Common Carrier Delivery**

All orders with any quantity of shades or blinds or any continuous valance 96" or more in width (or Vertical Applications over 96" in height) are considered oversize. Therefore, a net shipping charge of \$40 per oversized unit will be assessed.

Oversized orders that require expedited shipping will be quoted and charged accordingly.

Please see General Information for additional freight and shipping charge information.

---

## WHAT'S NEW FOR 2019

---

- New Simplicity Rechargeable motorization Top-Down/Bottom-Up – provides the flexibility of Top-Down/Bottom-Up with the ease of motorization.
- New Skylight with Simplicity motorization, now available with Rechargeable Battery. Rechargeable motorization offers expanded flexibility in this popular system, pair with a Solar Panel for true simplicity.
- Option of a single handle on Cordless Shades greater than 42" wide. A great option for windows needing the extension pole for access. Standardize the look across different widths.
- Continuous Cordloop Trilight now features the deluxe middle rail. Allows middle rail adjustability and a standard look across Trilight lifting systems.

---

## FEATURES & BENEFITS

---



- Their distinctive cellular construction helps insulate homes and reduce heating and cooling bills.
- Their superior sound absorption helps make surroundings quieter and more comfortable.
- 100% stain-resistant polyester fabric is wrinkle-resistant and easy to clean and maintain – most fabric styles are completely washable.
- Color choices include over 200 options from neutrals and bold colors to exclusive prints and solids.
- Multiple cell size choices, including 2" Hybrid Pleat, cover small- to large-scale windows, plus sliding glass doors.
- Fabric opacities range from sheer and semi-sheer to blackout, offering privacy and light control versatility. FR fabrics are also available.
- The neutral white backing on most fabric styles provides a consistent appearance to the outside of the home.
- Offered with a wide selection of control options, including top-down/bottom-up, continuous loop, cordless lift, vertical application and motorized control, to fit any need.
- Cordless lift, cordless lift & lock, continuous cord loop, RemoteLift 2.0 shades, and Simplicity shades are available with Fabric Covered rails for a surcharge.
- Optional color-coordinated rails are available at no additional cost.
- Features Versatile Innovations™ TriLight Shades® for enhanced versatility.
- Limited lifetime warranty ensures your customers' satisfaction.



# PATTERN INFORMATION

MOST PATTERNS ARE MADE FROM UNIQUE, DURABLE, POLYESTER FABRICS THAT REPEL DIRT, RESIST STAINS AND CLEAN EASILY.

Pattern Name	# of Cells	Price Group (Standard)	Winter R-Values	Summer Solar Heat Gain Coefficient	Care Code	Light Control	Hardware Restrictions	Hardware Options	
3/8" Marcella	H44	Single	2	4.92	0.41	1, 2 & 3	C	Cordless Lift & Lock, Two-Fabric Combo, Vertical Application, TriLight	<ul style="list-style-type: none"> <li>• Standard Cordlock</li> <li>• Continuous Cord Loop System</li> <li>• Continuous Cord Loop Top-Down/Bottom-Up</li> <li>• Cordless Lift System</li> <li>• Cordless Lift &amp; Lock</li> <li>• Two-Fabric Combination</li> <li>• Top-Down</li> <li>• Top-Down/Bottom-Up</li> <li>• Two-On-One Headrail</li> <li>• Vertical Application</li> <li>• Classic Skylight</li> <li>• Arches</li> <li>• Angles</li> <li>• Specialty Shapes</li> <li>• Battery Operated Motorization</li> <li>• TriLight</li> </ul>
3/8" Opulence	H40	Single	3	4.45	0.35	1, 2 & 3	C	Cordless Lift & Lock, Two-Fabric Combo, Vertical Application, TriLight	
3/8" Opulence Blackout	H41	Single	10	5.89	0.21	1, 2 & 3	E	Cordless, Cordless Lift & Lock, Two-Fabric Combo, Vertical App, TriLight	
3/4" Cardiff	H91	Single	6	4.49	0.36	1, 2 & 3	C	–	
3/4" Glimmer	HS3	Single	6	5.00	0.41	1, 2 & 3	C	–	
3/4" Linen	H27	Single	6	4.49	0.36	1, 2 & 3	C	–	
3/4" Marcella	H45	Single	4	5.00	0.41	1, 2 & 3	C	–	
3/4" Marcella Blackout	H46	Single	9	5.88	0.20	1, 2 & 3	E	–	
3/4" Melodic	HX6	Single	6	4.49	0.36	1, 2 & 3	C	–	
3/4" Mirada	H92	Single	6	4.49	0.36	1, 2 & 3	C	–	
3/4" Opulence	H28	Single	6	4.49	0.36	1, 2 & 3	C	–	
3/4" Opulence Blackout	H29	Single	11	4.87	0.25	1, 2 & 3	E	–	
3/4" Peaceful	H96	Single	12	4.49	0.36	1, 2 & 3	C	Arches	
3/4" Radiance	HF6	Single	1	4.49	0.36	1, 2 & 3	C	–	
3/4" Radiance Blackout	HF7	Single	7	5.88	0.20	1, 2 & 3	E	–	
3/4" Serene FR*	H62	Single	6	5.16	0.36	1, 2 & 3	C	–	
3/4" Serene FR Blackout*	H60	Single	11	5.74	0.25	1, 2 & 3	E	–	
3/4" Tiffany Sheer	H25	Single	11	3.72	0.22	1, 2 & 3	A	TriLight	
3/4" Tranquility Semi-Sheer	H24	Single	11	4.07	0.41	1, 2 & 3	B	TriLight, Vertical Application	
1/2" Marcella Double Cell	H47	Double	5	5.26	0.30	1, 2 & 3	C	Cordless Two-Fabric Combo, Vertical App	
1/2" Opulence Double Cell	H39	Double	8	4.78	0.30	1, 2 & 3	C	Cordless Two-Fabric Combo, Vertical App	
3/8" Tricella Triple Cell	H58	Triple	11	5.78	0.20	1, 2 & 3	C	Cordless, Cordless Lift & Lock, Cordless TDBU, Cordless Two-Fabric Combo, Vertical App, Skylight, Top-Down Arch, Motorization, TriLight	
2" Hybrid Pleat – Semi-Opaque	HPF	Single	13	4.53	N/A	1, 2 & 3	C	Standard Cordlock, Two-Fabric Combo, Skylight, Arches, Angles, Specialty Shapes, PowerWand	
2" Hybrid Pleat – Blackout	HPR	Single	14	4.78	N/A	1, 2 & 3	E	Standard Cordlock, Two-Fabric Combo, Skylight, Arches, Angles, Specialty Shapes, PowerWand	

\* Flame Resistant – Passes Flame Test NFPA 701

### Winter R-Values

R-Value measures resistance to heat loss. The higher the R-Value, the more insulation the product provides. In winter, higher insulation means less heat loss and a warmer room. (Double glaze window.)

### Summer Solar Heat Gain Coefficient

Coefficient measures the products ability to reduce heat gain from the sun. The lower the number, the less solar energy it transmits. In summer, less heat transmitted means a cooler room. (Double glaze window.)

### Care Method 1

Dusting with a feather, or synthetic, non-abrasive, material duster is recommended for all Honeycomb Shade surfaces which are lightly soiled.

### Care Method 2

Wiping with a soft, damp sponge or cloth, of non-abrasive material, with lukewarm water is recommended for all Honeycomb Shade surfaces which need spot cleaning.

### Care Method 3

Vacuuming with a soft bristle vacuum cleaner brush attachment is recommended for all Honeycomb Shade surfaces which are heavily soiled.



#### A. Glare Reducing

Softly filters light and reduces glare. Images, shapes and people can be seen clearly. Provides the least amount of light and shape screening.



#### B. Filtering

Filters strong light. Images, shapes and people can be seen with some clarity. Provides a modest degree of light and shape screening.



#### C. Shading

Significantly reduces light. Images, shapes and people cannot be seen clearly. Provides a moderate to strong degree of light and shape screening. Darker colored materials tend to provide stronger screening than lighter colored materials in this category.



#### D. Blocking

Dramatically reduces light. Images, shapes and people are not distinguishable. Provides privacy against most all direct light and shape screening (except minimal light that may seep through closed or overlapping opaque/blackout slats and vanes).



#### E. Blackout

Blocks out virtually all light (except light that may enter on the sides of the shade) for maximum privacy and darkness.

# FABRIC AND RAIL COLOR CHART

## 3/8" Single Cell Fabrics (Semi-Opaque & Blackout)

FABRIC			HARDWARE	
Code	Color #	Color Name	STD	VA
<b>MARCELLA Semi-Opaque (Price Group 2)</b>				
H44	807	Almond Glaze	630	N/A
H44	808	Brown Sugar	083	
H44	804	Crepe Souffle	882	
H44	803	Jasmine Wisp	674	
H44	802	Mountain Mist	862	
H44	801	Sugar Cane	661	

FABRIC			HARDWARE	
Code	Color #	Color Name	STD	VA
<b>OPULENCE Semi-Opaque (Price Group 3)</b>				
H40	606	Biscuit	882	N/A
H40	636	Chocolate Bliss	083	
H40	608	Cocoa	810	
H40	603	Doe	862	
H40	604	Fallen Snow	882	
H40	612	Gentle White	661	
H40	615	Sagebrush	621	
H40	629	Soft Linen	862	
H40	601	Soft White	661	
H40	617	Sunbeam	862	
H40	632	Tranquil Tea	954	
H40	637	Warm Cocoa	361	

FABRIC			HARDWARE	
Code	Color #	Color Name	STD	VA
<b>OPULENCE Blackout (Price Group 10)</b>				
H41	628	Cloud Puff	661	N/A
H41	703	Doe	862	
H41	702	Soft White	785	
H41	632	Tranquil Tea	954	

<b>CODE KEY: HEADRAIL</b>
STD = Standard Cordlock (Cordless Lift, Continuous Cord Loop, Simplicity and RemoteLift shades with coordinated rail.)
VA = Vertical Application shades

Hardware Colors			
		STD	VA
018	Satin Silver	X	N/A
048	Black	X	X
082	Camel	N/A	X
083	Cocoa	X	X
127	Cameo	X	N/A
135	Whisper Heather	X	N/A
276	Silverado	N/A	X
320	Rich Cream	X	N/A
361	Tender Taupe	X	N/A
405	Gray Flannel	X	N/A
450	Skyline	X	N/A
621	Putty	X	N/A
630	Gold Leaf	X	N/A
661	White Tiara	X	X
674	Bamboo Stalk	X	N/A
685	Blue Sky	X	N/A
765	Silver Maple	X	N/A
785	Aspen White	X	X
810	Mushroom	X	X
841	Dark Blonde	N/A	X
849	Mocha	X	N/A
862	Gardenia White	X	X
882	Honey Bisque	X	X
885	Flex White	X	N/A
952	Pristine Beach	X	N/A
954	Tranquil Tea	X	N/A
956	Renaissance Clay	X	N/A
958	Velvet Fern	X	N/A
960	Terra Cotta Urn	X	N/A

# FABRIC AND RAIL COLOR CHART

## 3/4" Single Cell Fabrics (Semi-Opaque, Semi-Sheer & Sheer)

FABRIC			HARDWARE	
Code	Color #	Color Name	STD	VA
<b>CARDIFF Semi-Opaque (Price Group 6)</b>				
H91	3002	Distant Range	320	862
H91	3003	Haystack	954	661
H91	3006	Riverfront	810	810
H91	3005	Skipping Stones	765	276
H91	3001	Star Gazing	785	785
H91	3004	Winter Forest	083	083
<b>GLIMMER Semi-Opaque (Price Group 6)</b>				
HS3	854	Copper Blaze	960	083
HS3	668	Copper Radiance	954	083
HS3	911	Copper Sage	958	785
HS3	989	Gold Brilliance	882	882
HS3	468	Gold Leaf	630	862
HS3	955	Gold Shimmer	862	862
HS3	682	Silver Birch	862	862
HS3	829	Silver River	765	661
HS3	686	Silver Truffle	810	810
<b>LINEN Semi-Opaque (Price Group 6)</b>				
H27	454	Dried Sage	621	862
H27	451	French Vanilla	882	882
H27	452	Harvest	630	841
H27	453	Khaki	630	841
<b>MARCELLA Semi-Opaque (Price Group 4)</b>				
H45	807	Almond Glaze	630	862
H45	808	Brown Sugar	083	083
H45	804	Crepe Souffle	882	882
H45	805	Fresh Toffee	952	082
H45	822	Grey Linen	765	276
H45	803	Jasmine Wisp	674	862
H45	8701	Mocha Brownie	810	810
H45	802	Mountain Mist	862	862
H45	821	Pearly Beige	862	862
H45	8703	Serious Gray	405	276
H45	8700	Spanish Olive	621	862
H45	801	Sugar Cane	661	661
<b>MELODIC Semi-Opaque (Price Group 6)</b>				
HX6	1053	Ballet	862	862
HX6	1051	Bravado	661	661
HX6	1089	Charango	862	862
HX6	1018	Ginger	320	862
HX6	1465	Jade	135	785
HX6	1469	Jave	849	810
HX6	1084	Meseno	810	810
HX6	1016	Padoanna	450	661
HX6	1055	Timbre	810	810
<b>MIRADA Semi-Opaque (Price Group 6)</b>				
H92	3021	Bungalow Brown	361	810
H92	3022	Lazy Day	785	785
H92	3025	Marina Gray	765	276
H92	3024	North Star	661	661
H92	3023	Relaxing Rain	405	276
H92	3026	Sonora Dunes	862	862

**\*\*IMPORTANT NOTE:\*\***

3/4" Serene FR Semi-opaque (H62) and 3/4" Serene FR Blackout (H60) fabrics do not meet the NFPA 701 flammability requirements when used in a Vertical Application.

CODE KEY: HEADRAIL	
<b>STD</b>	Standard Cordlock (Cordless Lift, Cordless Lift & Lock, Continuous Cord Loop, TriLight, Simplicity and Remotelift shades with coordinated rail.)
<b>VA</b>	Vertical Application shades

FABRIC			HARDWARE	
Code	Color #	Color Name	STD	VA
<b>OPULENCE Semi-Opaque (Price Group 6)</b>				
H28	651	Accent Grey	765	276
H28	606	Biscuit	882	882
H28	636	Chocolate Bliss	083	083
H28	608	Cocoa	810	810
H28	622	Country Road	621	862
H28	603	Doe	862	862
H28	604	Fallen Snow	882	882
H28	635	Fudge Truffle	954	082
H28	621	Gentle White	661	661
H28	653	Golden Sage	630	841
H28	652	Grey Stone	765	276
H28	5021	Nantucket Gray	405	276
H28	5022	Newport Gray	405	276
H28	631	Pristine Beach	954	082
H28	5020	Regal Taupe	810	810
H28	634	Renaissance Clay	956	862
H28	615	Sagebrush	621	785
H28	629	Soft Linen	862	862
H28	601	Soft White	661	661
H28	617	Sunbeam	862	862
H28	607	Taupe	127	862
H28	632	Tranquil Tea	954	082
H28	637	Warm Cocoa	361	810
H28	618	White Azalea	661	661
<b>PEACEFUL Semi-Opaque (Price Group 12)</b>				
H96	2222	Barely Beige	862	862
H96	2228	Blue Skies	450	661
H96	2225	Canyon Walls	954	082
H96	2229	Casting Pond	450	661
H96	2224	Country Crossing	882	882
H96	2223	Desert Dunes	862	862
H96	2221	Drop of Sun	785	785
H96	2226	Fair Oaks	810	810
H96	2227	Fallen Leaves	862	862
H96	2230	Mountain Meadow	135	785
H96	2220	Zephyr	661	661
<b>RADIANCE Semi-Opaque (Price Group 1)</b>				
HF6	445	Aged Brass	621	785
HF6	444	Aged Leather	083	083
HF6	439	Golden	630	862
HF6	458	Pewter	765	661
HF6	416	Primrose	630	862
HF6	448	Rosemary	958	785
HF6	454	Twilight	450	661
HF6	400	Vintage Lace	785	785

FABRIC			HARDWARE	
Code	Color #	Color Name	STD	VA
<b>SERENE FR Semi-Opaque (Price Group 6)</b>				
H62	263	Blanched Almond	862	862
H62	261	Lemon Chiffon	785	785
H62	262	Pearl Shell	882	882
H62	260	Snow White	661	661

FABRIC			HARDWARE	
Code	Color #	Color Name	STD	VA
<b>TIFFANY Sheer (Price Group 11)</b>				
H25	102	Almond Veil	882	882
H25	103	Soft Sand	862	862
H25	100	White Veil	661	661
<b>TRANQUILITY Semi-Sheer (Price Group 11)</b>				
H24	273	Desert Sand	882	N/A
H24	272	Pale Rose	320	
H24	274	Soft Buttercup	674	
H24	271	White Linen	661	

# FABRIC AND RAIL COLOR CHART

## 3/4" Single Cell Fabrics (Blackout)

FABRIC			HARDWARE	
Code	Color #	Color Name	STD	VA
<b>MARCELLA Blackout (Price Group 9)</b>				
H46	807	Almond Glaze	630	862
H46	808	Brown Sugar	954	083
H46	804	Crepe Souffle	882	882
H46	822	Grey Linen	765	276
H46	803	Jasmine Wisp	674	862
H46	802	Mountain Mist	862	862
H46	821	Pearly Beige	862	862
H46	801	Sugar Cane	661	661
<b>OPULENCE Blackout (Price Group 11)</b>				
H29	606	Biscuit	882	882
H29	628	Cloud Puff	661	661
H29	652	Deep Slate	450	661
H29	603	Doe	862	862
H29	690	Grey Stone	765	276
H29	5021	Nantucket Gray	405	276
H29	601	Soft White	785	785
H29	617	Sunbeam	862	862
H29	607	Taupe	127	862
H29	632	Tranquil Tea	954	082
H29	637	Warm Cocoa	849	810
H29	618	White Azalea	885	661

FABRIC			HARDWARE	
Code	Color #	Color Name	STD	VA
<b>RADIANCE Blackout (Price Group 7)</b>				
HF7	445	Aged Brass	621	785
HF7	444	Aged Leather	083	083
HF7	439	Golden	630	862
HF7	458	Pewter	765	661
HF7	416	Primrose	630	862
HF7	448	Rosemary	958	785
HF7	454	Twilight	450	661
HF7	400	Vintage Lace	785	785
<b>SERENE FR Blackout (Price Group 11)</b>				
H60	163	Blanched Almond	862	785
H60	160	Cool White	661	661
H60	161	Lemon Chiffon	785	785
H60	162	Pearl Shell	882	882

**\*\*IMPORTANT NOTE:\*\***

3/4" Serene FR Semi-opaque (H62) and 3/4" Serene FR Blackout (H60) fabrics do not meet the NFPA 701 flammability requirements when used in a Vertical Application.

CODE KEY: HEADRAIL
<b>STD = Standard Cordlock (Cordless Lift, Cordless Lift &amp; Lock, Continuous Cord Loop, TriLight, Simplicity and RemoteLift shades with coordinated rail.)</b>
<b>VA = Vertical Application shades</b>

## FABRIC AND RAIL COLOR CHART

### 1/2" Double Cell & 3/8" Triple Cell Fabrics

FABRIC			HARDWARE	
Code	Color #	Color Name	STD	VA
<b>MARCELLA Double Cell (Price Group 5)</b>				
H47	807	Almond Glaze	630	N/A
H47	808	Brown Sugar	083	
H47	804	Crepe Souffle	882	
H47	822	Grey Linen	765	
H47	803	Jasmine Wisp	674	
H47	802	Mountain Mist	862	
H47	821	Pearly Beige	862	
H47	801	Sugar Cane	661	

FABRIC			HARDWARE	
Code	Color #	Color Name	STD	VA
<b>OPULENCE Double Cell (Price Group 8)</b>				
H39	651	Accent Grey	765	N/A
H39	606	Biscuit	882	
H39	636	Chocolate Bliss	083	
H39	608	Cocoa	810	
H39	603	Doe	862	
H39	604	Fallen Snow	882	
H39	635	Fudge Truffle	954	
H39	652	Grey Stone	765	
H39	615	Sagebrush	621	
H39	629	Soft Linen	862	
H39	601	Soft White	661	
H39	617	Sunbeam	862	
H39	632	Tranquil Tea	954	
H39	637	Warm Cocoa	361	

FABRIC			HARDWARE	
Code	Color #	Color Name	STD	VA
<b>TRICELLA Triple Cell (Price Group 11)</b>				
H58	100	Cotton Bloom	661	N/A
H58	108	Dreamy Sunset	952	
H58	110	Foxy Gray	765	
H58	106	Malibu Coast	630	
H58	104	Sand Castle	862	
H58	102	Sun Glow	862	

CODE KEY: HEADRAIL
STD = Standard Cordlock (Cordless Lift, Cordless Lift & Lock, Continuous Cord Loop, TriLight, Simplicity and RemoteLift shades with coordinated rail.)
VA = Vertical Application shades



# FABRIC AND RAIL COLOR CHART

## 2" Hybrid Pleat (Semi-Opaque & Blackout)

FABRIC			HARDWARE	
Code	Color #	Color Name	OPTION	VA
<b>2" HYBRID PLEAT - Semi-Opaque (Price Group 13)</b>				
<i>Coordinates with Opulence colors of the same name</i>				
HPF	851	Accent Gray	765	276
HPF	808	Cocoa	810	810
HPF	803	Doe	862	862
HPF	852	Grey Stone	765	276
HPF	801	Soft White	661	661
HPF	817	Sunbeam	862	862

FABRIC			HARDWARE	
Code	Color #	Color Name	OPTION	VA
<b>2" HYBRID PLEAT - Blackout (Price Group 14)</b>				
<i>Coordinates with Opulence colors of the same name</i>				
HPR	828	Cloud Puff	661	661
HPR	812	Deep Slate	450	661
HPR	803	Doe	862	862
HPR	807	Taupe	127	862
HPR	832	Tranquil Tea	954	082
HPR	837	Warm Cocoa	361	810

CODE KEY: HEADRAIL	
OPTION	= Cordless Lift, Cordless Lift & Lock, Continuous Cord Loop, TriLight, Simplicity and RemoteLift shades with coordinated rail.
VA	= Vertical Application shades

**GROUP 1 (Standard Rectangular)**

• 3/4" Radiance (HF6)

WIDTH TO:	24"	30"	36"	42"	48"	54"	60"	66"	72"	84"	96"	108"	120"
<b>HEIGHT TO:</b>													
36"	\$206	234	262	296	326	354	384	413	444	508	572	639	703
42"	222	250	287	326	354	386	421	457	489	561	632	705	779
48"	238	275	308	347	384	421	459	498	535	613	696	770	855
54"	248	289	331	376	413	453	496	538	579	664	752	841	927
60"	266	305	354	397	441	487	528	577	627	719	811	910	1000
66"	284	326	377	423	471	521	568	618	666	770	873	972	1078
72"	296	342	397	450	505	554	605	660	712	823	931	1041	1154
78"	308	361	418	469	533	586	644	701	761	871	991	1108	1228
84"	322	379	439	498	558	613	673	733	793	915	1042	1163	1295
90"	335	395	459	521	586	650	710	777	841	972	1103	1233	1368
96"	347	411	480	545	613	674	747	811	876	1014	1156	1295	1435
108"	379	446	519	591	669	736	812	890	966	1115	1263	1416	1573
120"	402	482	567	644	728	804	888	970	1048	1209	1380	1547	1699

NOTE: SEE "PRODUCT CONFIGURATION SPECIFICATION" CHARTS ON PAGES 24-31 FOR ANY FABRIC AND SIZE RESTRICTIONS.

**OPTIONS: NO EXTRA CHARGE**

- **Color-Coordinated Rails**
- **Cordless Lift & Lock**
- **Cordless Lift & Lock Two-On-One Headrail** – price as 2 separate shades and add together
- **Cordless Lift & Lock Three-On-One Headrail** – price as 3 separate shades and add together
- **Control Positions** – left or right side of the shade (Exception: for Two-on-One Headrail, cords must be on opposite ends of the headrail)
- **3" Extension Bracket and 1/2" Spacer Blocks** – maximum of 3 spacer blocks per bracket
- **Hold Down Brackets**
- **Cut-Outs** – up to 3" wide (see page 27 for details)
- **Special Cord Lengths** – standard cord is 40% of the height of the shade unless otherwise specified
- **Hardware Color Override**

**OPTIONS: EXTRA CHARGE**

- See "SIZE STANDARDS" for complete option details.
- **Fabric-Wrapped Rail Option** .....add \$36
  - **Top-Down & Top-Down/Bottom-Up** .....add \$124
  - **Continuous Cord Loop\*** .....add \$89
    - **Top-Down/Bottom-Up\*** .....add \$213
  - **Cordless Lift System\*** .....add \$124
    - **Two-On-One Headrail\*** price as 2 separate shades and add \$248 (not available in Top-Down/Bottom-Up or Two-Fabric Combination)
    - **Three-On-One Headrail\*** price as 3 separate shades and add \$372 (not available in Top-Down/Bottom-Up or Two-Fabric Combination)
    - **Top-Down/Bottom-Up\*** .....add \$248
  - **Cordless Lift & Lock**
    - **Top-Down/Bottom-Up\*** .....add \$124
    - **Premium Headrail Upgrade\*** .....add \$23 (Premium Headrail not available with Top-Down/Bottom-Up or TriLight)
  - **Cordless Extension Pole #40-0036-000** .....\$61
  - **Rectangular Shade and Arch** – price as 2 separate shades; One Arch and One Rectangular
  - **TriLight Shades** – see pages 32-37
  - **Angle Cut** .....add \$199

\*NOTE: FABRIC-WRAPPED RAILS ARE OPTIONAL FOR A SURCHARGE ON CONTINUOUS CORD LOOP, CORDLESS LIFT, CORDLESS LIFT & LOCK, AND MOTORIZED SHADES. COLOR-COORDINATED RAILS ARE AVAILABLE AT NO ADDITIONAL CHARGE.

See page 23 for motorization surcharges

**GROUP 2 (Standard Rectangular)**

• 3/8" Marcella (H44)

WIDTH TO:	24"	30"	36"	42"	48"	54"	60"	66"	72"	84"	96"	108"	120"	132"	144"
<b>HEIGHT TO:</b>															
36"	\$206	234	262	296	326	354	384	413	444	508	572	639	703	770	828
42"	222	250	287	326	354	386	421	457	489	561	632	705	779	853	920
48"	238	275	308	347	384	421	459	498	535	613	696	770	855	931	1011
54"	248	289	331	376	413	453	496	538	579	664	752	841	927	1019	1104
60"	266	305	354	397	441	487	528	577	627	719	811	910	1000	1099	1189
66"	284	326	377	423	471	521	568	618	666	770	873	972	1078	1180	1283
72"	296	342	397	450	505	554	605	660	712	823	931	1041	1154	1258	1371
78"	308	361	418	469	533	586	644	701	761	871	991	1108	1228	1343	1462
84"	322	379	439	498	558	613	673	733	793	915	1042	1163	1295	1416	1543
90"	335	395	459	521	586	650	710	777	841	972	1103	1233	1368	1501	1630
96"	347	411	480	545	613	674	747	811	876	1014	1156	1295	1435	1571	
108"	379	446	519	591	669	736	812	890	966	1115	1263	1416	1573		
120"	402	482	567	644	728	804	888	970	1048	1209	1380	1547			
132"	430	515	602	692	782	867	959	1044	1131	1309	1493				
144"	457	549	648	736	839	929	1025	1118	1210	1407					

NOTE: SEE "PRODUCT CONFIGURATION SPECIFICATION" CHARTS ON PAGES 24-31 FOR ANY FABRIC AND SIZE RESTRICTIONS. CONTINUOUS CORD LOOP SYSTEM "REQUIRED" FOR SIZES WITHIN THE THICK BLACK LINE.

OPTIONS: NO EXTRA CHARGE	
<ul style="list-style-type: none"> <li>• <b>Color-Coordinated Rails</b></li> <li>• <b>Control Positions</b> – left or right side of the shade (Exception: for Two-on-One Headrail, cords must be on opposite ends of the headrail)</li> <li>• <b>3" Extension Bracket and 1/2" Spacer Blocks</b> – maximum of 3 spacer blocks per bracket</li> </ul>	<ul style="list-style-type: none"> <li>• <b>Hold Down Brackets</b></li> <li>• <b>Cut-Outs</b> – up to 3" wide (see page 27 for details)</li> <li>• <b>Special Cord Lengths</b> – standard cord is 40% of the height of the shade unless otherwise specified</li> <li>• <b>Hardware Color Override</b></li> </ul>

OPTIONS: EXTRA CHARGE	
<p>See "SIZE STANDARDS" for complete option details.</p> <ul style="list-style-type: none"> <li>• <b>Fabric-Wrapped Rail Option</b> .....add \$36</li> <li>• <b>Top-Down &amp; Top-Down/Bottom-Up</b> .....add \$124</li> <li>• <b>Continuous Cord Loop*</b> .....add \$89                             <ul style="list-style-type: none"> <li>– <b>Top-Down/Bottom-Up*</b> .....add \$213</li> </ul> </li> <li>• <b>Cordless Lift System*</b> .....add \$124                             <ul style="list-style-type: none"> <li>– <b>Two-On-One Headrail*</b> price as 2 separate shades and add \$248 (not available in Top-Down/Bottom-Up or Two-Fabric Combination)</li> <li>– <b>Three-On-One Headrail*</b> price as 3 separate shades and add \$372 (not available in Top-Down/Bottom-Up or Two-Fabric Combination)</li> <li>– <b>Top-Down/Bottom-Up*</b> .....add \$248</li> </ul> </li> </ul>	<ul style="list-style-type: none"> <li>• <b>Cordless Extension Pole #40-0036-000</b> .....\$61</li> <li>• <b>Rectangular Shade and Arch</b> – price as 2 separate shades; One Arch and One Rectangular</li> <li>• <b>Angle Cut</b> .....add \$199</li> </ul>

\*NOTE: FABRIC-WRAPPED RAILS ARE OPTIONAL FOR A SURCHARGE ON CONTINUOUS CORD LOOP, CORDLESS LIFT, CORDLESS LIFT & LOCK, AND MOTORIZED SHADES. COLOR-COORDINATED RAILS ARE AVAILABLE AT NO ADDITIONAL CHARGE.

See page 23 for motorization surcharges

**GROUP 3 (Standard Rectangular)**

• 3/8" Opulence (H40)

WIDTH TO:	24"	30"	36"	42"	48"	54"	60"	66"	72"	84"	96"	108"	120"	132"	144"
<b>HEIGHT TO:</b>															
36"	\$218	246	278	314	347	376	407	439	469	538	605	678	745	818	880
42"	232	266	305	344	376	411	450	482	517	593	669	747	827	903	975
48"	250	287	326	365	407	450	485	526	567	650	735	819	906	993	1074
54"	264	305	353	397	439	480	524	570	614	706	797	890	988	1080	1172
60"	280	322	376	418	466	515	563	611	660	763	860	965	1064	1168	1262
66"	301	347	400	452	503	554	602	655	706	818	929	1030	1145	1253	1363
72"	314	361	418	476	535	588	644	701	756	874	993	1106	1226	1341	1456
78"	326	381	444	501	565	620	685	743	807	927	1053	1179	1302	1428	1552
84"	340	402	464	526	591	650	715	781	842	970	1108	1237	1375	1504	1640
90"	356	418	487	554	620	689	754	825	892	1028	1170	1308	1451	1594	1734
96"	365	436	508	581	650	717	789	860	934	1078	1228	1373	1522	1667	
108"	402	471	551	630	708	784	865	942	1023	1184	1345	1504	1670		
120"	425	510	598	685	774	853	940	1026	1113	1285	1463	1642			
132"	455	545	639	733	832	924	1016	1110	1200	1393	1585				
144"	482	584	687	784	888	991	1087	1189	1290	1497					

NOTE: SEE "PRODUCT CONFIGURATION SPECIFICATION" CHARTS ON PAGES 24-31 FOR ANY FABRIC AND SIZE RESTRICTIONS. CONTINUOUS CORD LOOP SYSTEM "REQUIRED" FOR SIZES WITHIN THE THICK BLACK LINE.

**OPTIONS: NO EXTRA CHARGE**

- Color-Coordinated Rails
- Control Positions – left or right side of the shade (Exception: for Two-on-One Headrail, cords must be on opposite ends of the headrail)
- 3" Extension Bracket and 1/2" Spacer Blocks – maximum of 3 spacer blocks per bracket
- Hold Down Brackets
- Cut-Outs – up to 3" wide (see page 27 for details)
- Special Cord Lengths – standard cord is 40% of the height of the shade unless otherwise specified
- Hardware Color Override

**OPTIONS: EXTRA CHARGE**

- See "SIZE STANDARDS" for complete option details.
- Fabric-Wrapped Rail Option .....add \$36
  - Top-Down & Top-Down/Bottom-Up .....add \$124
  - Continuous Cord Loop\* .....add \$89
    - Top-Down/Bottom-Up\* .....add \$213
  - Cordless Lift System\* .....add \$124
    - Two-On-One Headrail\* price as 2 separate shades and add \$248 (not available in Top-Down/Bottom-Up or Two-Fabric Combination)
    - Three-On-One Headrail\* price as 3 separate shades and add \$372 (not available in Top-Down/Bottom-Up or Two-Fabric Combination)
    - Top-Down/Bottom-Up\* .....add \$248
  - Cordless Extension Pole #40-0036-000 .....\$61
  - Rectangular Shade and Arch – price as 2 separate shades; One Arch and One Rectangular
  - Angle Cut .....add \$199

\*NOTE: FABRIC-WRAPPED RAILS ARE OPTIONAL FOR A SURCHARGE ON CONTINUOUS CORD LOOP, CORDLESS LIFT, CORDLESS LIFT & LOCK, AND MOTORIZED SHADES. COLOR-COORDINATED RAILS ARE AVAILABLE AT NO ADDITIONAL CHARGE.

See page 23 for motorization surcharges

**GROUP 4 (Standard Rectangular)**

\*3/4" Marcella (H45)

WIDTH TO:	24"	30"	36"	42"	48"	54"	60"	66"	72"	84"	96"	108"	120"	132"	144"	174"
<b>HEIGHT TO:</b>																
36"	\$218	243	278	308	340	367	397	432	460	524	593	657	722	786	850	1014
42"	234	266	301	340	376	411	444	482	517	590	662	735	812	888	963	1140
48"	245	285	326	365	402	439	480	517	561	639	720	800	883	968	1044	1248
54"	257	298	342	386	432	469	515	556	600	683	777	864	961	1041	1131	1350
60"	280	322	372	414	462	510	554	604	651	749	844	940	1042	1136	1235	1470
66"	296	344	395	446	499	552	602	653	706	811	919	1023	1131	1237	1341	1605
72"	315	358	414	469	526	579	636	692	749	858	973	1090	1198	1313	1421	1706
78"	331	386	448	508	570	627	685	749	811	929	1057	1180	1306	1432	1552	1858
84"	347	406	469	536	602	662	728	791	858	986	1118	1251	1389	1515	1647	1976
90"	361	429	498	567	639	703	770	841	911	1049	1187	1329	1470	1612	1752	2102
96"	377	446	517	591	666	733	809	881	959	1104	1255	1400	1552	1700	1845	2130
108"	406	482	567	644	728	804	881	968	1048	1205	1370	1534	1700	1858	2024	2429
120"	446	526	620	710	802	890	977	1067	1157	1334	1516	1700	1883	2059	2243	2693
132"	480	577	673	775	874	972	1067	1168	1263	1465	1665	1867	2072	2261	2468	
144"	506	613	720	828	931	1039	1140	1249	1359	1571	1784	1996	2215	2427	2634	
156"	538	655	777	888	1009	1120										
168"	574	699	828	950	1078											
174"	602	736	876	1011	1140											

NOTE: SEE "PRODUCT CONFIGURATION SPECIFICATION" CHARTS ON PAGES 24-31 FOR ANY FABRIC AND SIZE RESTRICTIONS. CONTINUOUS CORD LOOP SYSTEM "REQUIRED" FOR SIZES WITHIN THE THICK BLACK LINE.

OPTIONS: NO EXTRA CHARGE	
<ul style="list-style-type: none"> <li>• Color-Coordinated Rails</li> <li>• Cordless Lift &amp; Lock</li> <li>• Cordless Lift &amp; Lock Two-On-One Headrail – price as 2 separate shades and add together</li> <li>• Cordless Lift &amp; Lock Three-On-One Headrail – price as 3 separate shades and add together</li> </ul>	<ul style="list-style-type: none"> <li>• Control Positions – left or right side of the shade (Exception: for Two-on-One Headrail, cords must be on opposite ends of the headrail)</li> <li>• 3" Extension Bracket and 1/2" Spacer Blocks – maximum of 3 spacer blocks per bracket</li> <li>• Hold Down Brackets</li> <li>• Cut-Outs – up to 3" wide (see page 27 for details)</li> <li>• Special Cord Lengths – standard cord is 40% of the height of the shade unless otherwise specified</li> <li>• Hardware Color Override</li> </ul>

OPTIONS: EXTRA CHARGE	
See "SIZE STANDARDS" for complete option details.	
<ul style="list-style-type: none"> <li>• Fabric-Wrapped Rail Option .....add \$36</li> <li>• Top-Down &amp; Top-Down/Bottom-Up .....add \$124</li> <li>• Continuous Cord Loop* .....add \$89                             <ul style="list-style-type: none"> <li>– Top-Down/Bottom-Up* .....add \$213</li> </ul> </li> <li>• Cordless Lift System* .....add \$124                             <ul style="list-style-type: none"> <li>– Two-On-One Headrail* price as 2 separate shades and add \$248 (not available in Top-Down/Bottom-Up or Two-Fabric Combination)</li> <li>– Three-On-One Headrail* price as 3 separate shades and add \$372 (not available in Top-Down/Bottom-Up or Two-Fabric Combination)</li> <li>– Top-Down/Bottom-Up* .....add \$248</li> </ul> </li> </ul>	<ul style="list-style-type: none"> <li>• Cordless Lift &amp; Lock                             <ul style="list-style-type: none"> <li>– Top-Down/Bottom-Up* .....add \$124</li> <li>– Premium Headrail Upgrade* .....add \$23 (Premium Headrail not available with Top-Down/Bottom-Up or TriLight)</li> </ul> </li> <li>• Cordless Extension Pole #40-0036-000 .....\$61</li> <li>• Rectangular Shade and Arch – price as 2 separate shades; One Arch and One Rectangular</li> <li>• TriLight Shades – see pages 32-37</li> <li>• Angle Cut .....add \$199</li> </ul>

\*NOTE: FABRIC-WRAPPED RAILS ARE OPTIONAL FOR A SURCHARGE ON CONTINUOUS CORD LOOP, CORDLESS LIFT, CORDLESS LIFT & LOCK, AND MOTORIZED SHADES. COLOR-COORDINATED RAILS ARE AVAILABLE AT NO ADDITIONAL CHARGE.

See page 23 for motorization surcharges



**GROUP 5 (Standard Rectangular)**

• 1/2" MARCELLA (H47)

WIDTH TO:	24"	30"	36"	42"	48"	54"	60"	66"	72"	84"	96"	108"	120"	132"	144"
<b>HEIGHT TO:</b>															
36"	\$229	255	291	328	361	388	421	457	489	558	630	697	768	834	901
42"	246	282	317	361	395	434	467	510	547	623	705	781	862	938	1021
48"	259	303	344	386	429	464	508	549	593	674	765	850	936	1025	1104
54"	275	315	365	411	457	501	545	590	636	726	825	917	1014	1101	1196
60"	296	340	393	441	490	540	588	641	692	791	896	998	1103	1202	1306
66"	314	367	418	469	526	582	639	696	749	860	973	1083	1196	1308	1426
72"	331	381	441	501	561	614	673	731	791	910	1034	1154	1272	1391	1506
78"	351	411	473	538	604	662	728	791	860	986	1120	1249	1386	1516	1646
84"	368	432	501	568	639	705	774	841	910	1046	1187	1329	1470	1605	1748
90"	383	452	524	600	674	743	816	892	966	1113	1256	1405	1562	1709	1856
96"	398	469	549	628	708	779	858	934	1012	1170	1331	1485	1646	1799	1953
108"	432	510	600	682	774	855	934	1025	1110	1279	1451	1624	1799	1971	2148
120"	469	561	657	752	850	940	1039	1133	1230	1416	1607	1799	1996	2187	2378
132"	508	609	715	823	927	1030	1134	1239	1341	1554	1768	1978	2194	2399	2615
144"	536	650	765	874	988	1099	1207	1327	1440	1663	1888	2118	2348	2574	2795

NOTE: SEE "PRODUCT CONFIGURATION SPECIFICATION" CHARTS ON PAGES 24-31 FOR ANY FABRIC AND SIZE RESTRICTIONS. CONTINUOUS CORD LOOP SYSTEM "REQUIRED" FOR SIZES WITHIN THE THICK BLACK LINE.

**OPTIONS: NO EXTRA CHARGE**

- **Color-Coordinated Rails**
- **Cordless Lift & Lock**
- **Cordless Lift & Lock Two-On-One Headrail** – price as 2 separate shades and add together
- **Cordless Lift & Lock Three-On-One Headrail** – price as 3 separate shades and add together
- **Control Positions** – left or right side of the shade (Exception: for Two-on-One Headrail, cords must be on opposite ends of the headrail)
- **3" Extension Bracket and 1/2" Spacer Blocks** – maximum of 3 spacer blocks per bracket
- **Hold Down Brackets**
- **Cut-Outs** – up to 3" wide (see page 27 for details)
- **Special Cord Lengths** – standard cord is 40% of the height of the shade unless otherwise specified
- **Hardware Color Override**

**OPTIONS: EXTRA CHARGE**

- See "SIZE STANDARDS" for complete option details.
- **Fabric-Wrapped Rail Option** .....add \$36
  - **Top-Down & Top-Down/Bottom-Up** .....add \$124
  - **Continuous Cord Loop\*** .....add \$89
    - **Top-Down/Bottom-Up\*** .....add \$213
  - **Cordless Lift System\*** .....add \$124
    - **Two-On-One Headrail\*** price as 2 separate shades and add \$248 (not available in Top-Down/Bottom-Up or Two-Fabric Combination)
    - **Three-On-One Headrail\*** price as 3 separate shades and add \$372 (not available in Top-Down/Bottom-Up or Two-Fabric Combination)
    - **Top-Down/Bottom-Up\*** .....add \$248
  - **Cordless Lift & Lock**
    - **Top-Down/Bottom-Up\*** .....add \$124
    - **Premium Headrail Upgrade\*** .....add \$23 (Premium Headrail not available with Top-Down/Bottom-Up or TriLight)
  - **Cordless Extension Pole #40-0036-000** .....\$61
  - **Rectangular Shade and Arch** – price as 2 separate shades; One Arch and One Rectangular
  - **TriLight Shades** – see pages 32-37
  - **Angle Cut** .....add \$199

\*NOTE: FABRIC-WRAPPED RAILS ARE OPTIONAL FOR A SURCHARGE ON CONTINUOUS CORD LOOP, CORDLESS LIFT, CORDLESS LIFT & LOCK, AND MOTORIZED SHADES. COLOR-COORDINATED RAILS ARE AVAILABLE AT NO ADDITIONAL CHARGE.

See page 23 for motorization surcharges

- 3/4" CARDIFF (H91)
- 3/4" MELODIC (HX6)
- 3/4" SERENE FR (H62)
- 3/4" GLIMMER (HS3)
- 3/4" MIRADA (H92)
- 3/4" LINEN (H27)
- 3/4" OPULENCE (H28)

**GROUP 6 (Standard Rectangular)**

WIDTH TO:	24"	30"	36"	42"	48"	54"	60"	66"	72"	84"	96"	108"	120"	132"	144"	174"
<b>HEIGHT TO:</b>																
36"	\$250	284	324	361	398	430	466	506	540	616	699	772	850	924	996	1193
42"	275	310	351	398	439	480	519	565	605	692	779	865	957	1042	1131	1340
48"	287	333	381	429	471	513	563	607	657	751	844	938	1041	1136	1228	1467
54"	303	349	400	453	506	554	604	653	705	804	913	1014	1126	1225	1329	1589
60"	328	377	436	487	544	597	651	710	766	876	993	1106	1226	1334	1447	1729
66"	347	402	462	521	586	648	706	768	828	952	1078	1200	1329	1451	1578	1884
72"	368	420	487	554	618	680	747	811	876	1007	1143	1278	1409	1543	1669	2003
78"	388	453	524	595	669	733	807	876	952	1095	1244	1386	1534	1681	1824	2187
84"	404	476	554	630	706	779	857	929	1007	1159	1315	1470	1631	1780	1934	2325
90"	421	501	582	662	749	825	906	988	1067	1235	1394	1562	1729	1893	2058	2472
96"	443	521	607	697	782	864	950	1039	1122	1297	1474	1647	1824	1994	2169	2502
108"	476	565	662	758	857	945	1039	1136	1233	1419	1608	1803	1994	2187	2383	2859
120"	521	618	728	834	940	1044	1147	1253	1361	1570	1782	1994	2213	2424	2634	3167
132"	563	674	791	911	1032	1140	1255	1373	1488	1722	1960	2194	2435	2663	2898	
144"	593	719	844	972	1097	1217	1340	1469	1596	1845	2097	2348	2606	2855	3100	
156"	632	770	913	1042	1187	1318										
168"	673	819	973	1117	1267											
174"	708	867	1034	1189	1340											

NOTE: SEE "PRODUCT CONFIGURATION SPECIFICATION" CHARTS ON PAGES 24-31 FOR ANY FABRIC AND SIZE RESTRICTIONS. CONTINUOUS CORD LOOP SYSTEM "REQUIRED" FOR SIZES WITHIN THE THICK BLACK LINE.

**OPTIONS: NO EXTRA CHARGE**

- Color-Coordinated Rails
- Cordless Lift & Lock
- Cordless Lift & Lock Two-On-One Headrail – price as 2 separate shades and add together
- Cordless Lift & Lock Three-On-One Headrail – price as 3 separate shades and add together
- Control Positions – left or right side of the shade (Exception: for Two-on-One Headrail, cords must be on opposite ends of the headrail)
- 3" Extension Bracket and 1/2" Spacer Blocks – maximum of 3 spacer blocks per bracket
- Hold Down Brackets
- Cut-Outs – up to 3" wide (see page 27 for details)
- Special Cord Lengths – standard cord is 40% of the height of the shade unless otherwise specified
- Hardware Color Override

**OPTIONS: EXTRA CHARGE**

- See "SIZE STANDARDS" for complete option details.
- Fabric-Wrapped Rail Option .....add \$36
  - Top-Down & Top-Down/Bottom-Up .....add \$124
  - Continuous Cord Loop\* .....add \$89
    - Top-Down/Bottom-Up\* .....add \$213
  - Cordless Lift System\* .....add \$124
    - Two-On-One Headrail\* price as 2 separate shades and add \$248 (not available in Top-Down/Bottom-Up or Two-Fabric Combination)
    - Three-On-One Headrail\* price as 3 separate shades and add \$372 (not available in Top-Down/Bottom-Up or Two-Fabric Combination)
    - Top-Down/Bottom-Up\* .....add \$248
  - Cordless Lift & Lock
    - Top-Down/Bottom-Up\* .....add \$124
    - Premium Headrail Upgrade\* .....add \$23 (Premium Headrail not available with Top-Down/Bottom-Up or TriLight)
  - Cordless Extension Pole #40-0036-000 .....\$61
  - Rectangular Shade and Arch – price as 2 separate shades; One Arch and One Rectangular
  - TriLight Shades – see pages 32-37
  - Angle Cut .....add \$199

\*NOTE: FABRIC-WRAPPED RAILS ARE OPTIONAL FOR A SURCHARGE ON CONTINUOUS CORD LOOP, CORDLESS LIFT, CORDLESS LIFT & LOCK, AND MOTORIZED SHADES. COLOR-COORDINATED RAILS ARE AVAILABLE AT NO ADDITIONAL CHARGE.

See page 23 for motorization surcharges

**GROUP 7 (Standard Rectangular)**

• 3/4" RADIANCE BLACKOUT (HF7)

WIDTH TO:	24"	30"	36"	42"	48"	54"	60"	66"	72"	84"	96"	108"	120"
<b>HEIGHT TO:</b>													
36"	\$269	301	344	384	423	457	498	536	574	655	736	818	904
42"	289	330	372	423	464	510	552	597	644	731	828	919	1012
48"	307	354	402	453	505	545	595	648	699	797	896	996	1103
54"	322	370	429	482	536	588	643	696	747	855	968	1074	1193
60"	349	398	462	515	577	634	692	754	811	929	1053	1177	1297
66"	368	430	494	554	620	685	749	812	876	1009	1143	1276	1407
72"	390	446	515	588	657	722	791	860	929	1067	1210	1355	1499
78"	413	482	558	632	710	779	857	929	1009	1161	1320	1469	1628
84"	432	508	588	666	749	828	910	988	1067	1232	1394	1562	1730
90"	448	533	618	705	793	873	961	1049	1134	1306	1479	1656	1835
96"	467	554	648	735	832	917	1007	1101	1191	1375	1566	1748	1932
108"	508	597	705	802	910	1002	1101	1203	1304	1506	1707	1914	2116
120"	554	657	774	883	998	1106	1217	1331	1442	1663	1888	2116	2348

NOTE: SEE "PRODUCT CONFIGURATION SPECIFICATION" CHARTS ON PAGES 24-31 FOR ANY FABRIC AND SIZE RESTRICTIONS.

OPTIONS: NO EXTRA CHARGE	
<ul style="list-style-type: none"> <li>• Color-Coordinated Rails</li> <li>• Cordless Lift &amp; Lock</li> <li>• Cordless Lift &amp; Lock Two-On-One Headrail – price as 2 separate shades and add together</li> <li>• Cordless Lift &amp; Lock Three-On-One Headrail – price as 3 separate shades and add together</li> </ul>	<ul style="list-style-type: none"> <li>• Control Positions – left or right side of the shade (Exception: for Two-on-One Headrail, cords must be on opposite ends of the headrail)</li> <li>• 3" Extension Bracket and 1/2" Spacer Blocks – maximum of 3 spacer blocks per bracket</li> <li>• Hold Down Brackets</li> <li>• Cut-Outs – up to 3" wide (see page 27 for details)</li> <li>• Special Cord Lengths – standard cord is 40% of the height of the shade unless otherwise specified</li> <li>• Hardware Color Override</li> </ul>

OPTIONS: EXTRA CHARGE	
<p>See "SIZE STANDARDS" for complete option details.</p> <ul style="list-style-type: none"> <li>• Fabric-Wrapped Rail Option .....add \$36</li> <li>• Top-Down &amp; Top-Down/Bottom-Up .....add \$124</li> <li>• Continuous Cord Loop* .....add \$89                             <ul style="list-style-type: none"> <li>– Top-Down/Bottom-Up* .....add \$213</li> </ul> </li> <li>• Cordless Lift System* .....add \$124                             <ul style="list-style-type: none"> <li>– Two-On-One Headrail* price as 2 separate shades and add \$248 (not available in Top-Down/Bottom-Up or Two-Fabric Combination)</li> <li>– Three-On-One Headrail* price as 3 separate shades and add \$372 (not available in Top-Down/Bottom-Up or Two-Fabric Combination)</li> <li>– Top-Down/Bottom-Up* .....add \$248</li> </ul> </li> </ul>	<ul style="list-style-type: none"> <li>• Cordless Lift &amp; Lock                             <ul style="list-style-type: none"> <li>– Top-Down/Bottom-Up* .....add \$124</li> <li>– Premium Headrail Upgrade* .....add \$23 (Premium Headrail not available with Top-Down/Bottom-Up or TriLight)</li> </ul> </li> <li>• Cordless Extension Pole #40-0036-000 .....\$61</li> <li>• Rectangular Shade and Arch – price as 2 separate shades; One Arch and One Rectangular</li> <li>• TriLight Shades – see pages 32-37</li> <li>• Angle Cut .....add \$199</li> </ul>

\*NOTE: FABRIC-WRAPPED RAILS ARE OPTIONAL FOR A SURCHARGE ON CONTINUOUS CORD LOOP, CORDLESS LIFT, CORDLESS LIFT & LOCK, AND MOTORIZED SHADES. COLOR-COORDINATED RAILS ARE AVAILABLE AT NO ADDITIONAL CHARGE.

See page 23 for motorization surcharges

**GROUP 8 (Standard Rectangular)**

• 1/2" OPULENCE (H39)

WIDTH TO:	24"	30"	36"	42"	48"	54"	60"	66"	72"	84"	96"	108"	120"	132"	144"
<b>HEIGHT TO:</b>															
36"	\$269	301	344	384	423	457	498	536	574	655	736	818	904	982	1057
42"	289	330	372	423	464	510	552	597	644	731	828	919	1012	1104	1198
48"	307	354	402	453	505	545	595	648	699	797	896	996	1103	1203	1299
54"	322	370	429	482	536	588	643	696	747	855	968	1074	1193	1295	1407
60"	349	398	462	515	577	634	692	754	811	929	1053	1177	1297	1416	1536
66"	368	430	494	554	620	685	749	812	876	1009	1143	1276	1407	1538	1672
72"	390	446	515	588	657	722	791	860	929	1067	1210	1355	1499	1637	1773
78"	413	482	558	632	710	779	857	929	1009	1161	1320	1469	1628	1782	1932
84"	432	508	588	666	749	828	910	988	1067	1232	1394	1562	1730	1886	2052
90"	448	533	618	705	793	873	961	1049	1134	1306	1479	1656	1835	2008	2183
96"	467	554	648	735	832	917	1007	1101	1191	1375	1566	1748	1932	2116	2298
108"	508	597	705	802	910	1002	1101	1203	1304	1506	1707	1914	2116	2316	2525
120"	554	657	774	883	998	1106	1217	1331	1442	1663	1888	2116	2348	2569	2795
132"	595	719	841	966	1095	1207	1332	1455	1578	1826	2077	2328	2581	2820	3075
144"	630	765	896	1032	1163	1294	1423	1561	1695	1959	2222	2489	2762	3027	3291

NOTE: SEE "PRODUCT CONFIGURATION SPECIFICATION" CHARTS ON PAGES 24-31 FOR ANY FABRIC AND SIZE RESTRICTIONS. CONTINUOUS CORD LOOP SYSTEM "REQUIRED" FOR SIZES WITHIN THE THICK BLACK LINE.

**OPTIONS: NO EXTRA CHARGE**

- **Color-Coordinated Rails**
- **Cordless Lift & Lock**
- **Cordless Lift & Lock Two-On-One Headrail** – price as 2 separate shades and add together
- **Cordless Lift & Lock Three-On-One Headrail** – price as 3 separate shades and add together
- **Control Positions** – left or right side of the shade (Exception: for Two-on-One Headrail, cords must be on opposite ends of the headrail)
- **3" Extension Bracket and 1/2" Spacer Blocks** – maximum of 3 spacer blocks per bracket
- **Hold Down Brackets**
- **Cut-Outs** – up to 3" wide (see page 27 for details)
- **Special Cord Lengths** – standard cord is 40% of the height of the shade unless otherwise specified
- **Hardware Color Override**

**OPTIONS: EXTRA CHARGE**

- See "SIZE STANDARDS" for complete option details.
- **Fabric-Wrapped Rail Option** .....add \$36
  - **Top-Down & Top-Down/Bottom-Up** .....add \$124
  - **Continuous Cord Loop\*** .....add \$89
    - **Top-Down/Bottom-Up\*** .....add \$213
  - **Cordless Lift System\*** .....add \$124
    - **Two-On-One Headrail\*** price as 2 separate shades and add \$248 (not available in Top-Down/Bottom-Up or Two-Fabric Combination)
    - **Three-On-One Headrail\*** price as 3 separate shades and add \$372 (not available in Top-Down/Bottom-Up or Two-Fabric Combination)
    - **Top-Down/Bottom-Up\*** .....add \$248
  - **Cordless Lift & Lock**
    - **Top-Down/Bottom-Up\*** .....add \$124
    - **Premium Headrail Upgrade\*** .....add \$23 (Premium Headrail not available with Top-Down/Bottom-Up or TriLight)
  - **Cordless Extension Pole #40-0036-000** .....\$61
  - **Rectangular Shade and Arch** – price as 2 separate shades; One Arch and One Rectangular
  - **TriLight Shades** – see pages 32-37
  - **Angle Cut** .....add \$199

\*NOTE: FABRIC-WRAPPED RAILS ARE OPTIONAL FOR A SURCHARGE ON CONTINUOUS CORD LOOP, CORDLESS LIFT, CORDLESS LIFT & LOCK, AND MOTORIZED SHADES. COLOR-COORDINATED RAILS ARE AVAILABLE AT NO ADDITIONAL CHARGE.

See page 23 for motorization surcharges

**GROUP 9 (Standard Rectangular)**

• 3/4" MARCELLA BLACKOUT (H46)

WIDTH TO:	24"	30"	36"	42"	48"	54"	60"	66"	72"	84"	96"	108"	120"	132"	144"	174"
<b>HEIGHT TO:</b>																
36"	\$276	308	349	386	429	466	506	545	586	666	758	841	927	1011	1094	1309
42"	296	333	379	423	467	517	556	602	650	747	841	934	1037	1131	1228	1467
48"	322	367	420	469	519	572	620	674	728	835	947	1057	1175	1278	1389	1665
54"	342	388	448	508	565	618	673	733	791	913	1034	1156	1278	1396	1518	1821
60"	376	414	480	545	602	664	722	791	858	986	1118	1249	1384	1518	1646	1980
66"	388	441	510	577	648	712	777	850	919	1057	1202	1348	1493	1630	1776	2134
72"	414	471	549	623	699	770	841	922	993	1149	1309	1463	1623	1780	1932	2332
78"	436	498	577	657	736	818	894	979	1057	1226	1393	1561	1730	1893	2063	2488
84"	453	521	607	699	779	862	940	1037	1118	1299	1472	1653	1835	2014	2192	2647
90"	480	554	650	735	828	920	1007	1104	1198	1389	1577	1773	1968	2155	2351	2836
96"	498	577	674	772	869	966	1057	1161	1256	1456	1663	1867	2074	2281	2480	2995
108"	536	628	736	846	959	1062	1163	1278	1386	1607	1833	2058	2289	2516	2742	3307
120"	577	682	800	919	1065	1154	1272	1394	1513	1755	1999	2251	2502	2755	3034	3673
132"	623	736	871	1002	1163	1258	1391	1524	1656	1923	2196	2470	2746	3022	3340	
144"	660	791	929	1071	1258	1361	1501	1642	1784	2072	2364	2663	2940	3241	3570	
156"	715	855	1007	1163	1366	1470										
168"	763	913	1074	1248	1462											
174"	804	965	1140	1318	1547											

NOTE: SEE "PRODUCT CONFIGURATION SPECIFICATION" CHARTS ON PAGES 24-31 FOR ANY FABRIC AND SIZE RESTRICTIONS. CONTINUOUS CORD LOOP SYSTEM "REQUIRED" FOR SIZES WITHIN THE THICK BLACK LINE.

**OPTIONS: NO EXTRA CHARGE**

- **Color-Coordinated Rails**
- **Cordless Lift & Lock**
- **Cordless Lift & Lock Two-On-One Headrail** – price as 2 separate shades and add together
- **Cordless Lift & Lock Three-On-One Headrail** – price as 3 separate shades and add together
- **Control Positions** – left or right side of the shade (Exception: for Two-on-One Headrail, cords must be on opposite ends of the headrail)
- **3" Extension Bracket and 1/2" Spacer Blocks** – maximum of 3 spacer blocks per bracket
- **Hold Down Brackets**
- **Cut-Outs** – up to 3" wide (see page 27 for details)
- **Special Cord Lengths** – standard cord is 40% of the height of the shade unless otherwise specified
- **Hardware Color Override**

**OPTIONS: EXTRA CHARGE**

- See "SIZE STANDARDS" for complete option details.
- **Fabric-Wrapped Rail Option** .....add \$36
  - **Top-Down & Top-Down/Bottom-Up** .....add \$124
  - **Continuous Cord Loop\*** .....add \$89
    - **Top-Down/Bottom-Up\*** .....add \$213
  - **Cordless Lift System\*** .....add \$124
    - **Two-On-One Headrail\*** price as 2 separate shades and add \$248 (not available in Top-Down/Bottom-Up or Two-Fabric Combination)
    - **Three-On-One Headrail\*** price as 3 separate shades and add \$372 (not available in Top-Down/Bottom-Up or Two-Fabric Combination)
    - **Top-Down/Bottom-Up\*** .....add \$248
  - **Cordless Lift & Lock**
    - **Top-Down/Bottom-Up\*** .....add \$124
    - **Premium Headrail Upgrade\*** .....add \$23 (Premium Headrail not available with Top-Down/Bottom-Up or TriLight)
  - **Cordless Extension Pole #40-0036-000** .....\$61
  - **Rectangular Shade and Arch** – price as 2 separate shades; One Arch and One Rectangular
  - **TriLight Shades** – see pages 32-37
  - **Angle Cut** .....add \$199

\*NOTE: FABRIC-WRAPPED RAILS ARE OPTIONAL FOR A SURCHARGE ON CONTINUOUS CORD LOOP, CORDLESS LIFT, CORDLESS LIFT & LOCK, AND MOTORIZED SHADES. COLOR-COORDINATED RAILS ARE AVAILABLE AT NO ADDITIONAL CHARGE.

See page 23 for motorization surcharges



**GROUP 10 (Standard Rectangular)**

• 3/8" OPULENCE BLACKOUT (H41)

WIDTH TO:	24"	30"	36"	42"	48"	54"	60"	66"	72"	84"	96"	108"	120"	132"	144"
<b>HEIGHT TO:</b>															
36"	\$310	347	390	436	482	526	568	616	659	752	857	950	1051	1143	1235
42"	333	376	427	480	531	582	628	680	733	839	950	1058	1166	1278	1386
48"	363	414	475	533	586	644	699	763	823	945	1071	1196	1325	1444	1570
54"	384	439	505	572	636	697	761	830	892	1028	1164	1306	1444	1580	1715
60"	421	467	542	616	682	751	818	894	968	1115	1263	1412	1562	1715	1858
66"	439	496	574	650	731	804	878	957	1037	1196	1361	1524	1688	1844	2008
72"	467	535	620	701	786	871	950	1041	1122	1301	1481	1654	1837	2012	2189
78"	492	559	650	742	834	924	1009	1104	1196	1382	1575	1762	1959	2143	2332
84"	512	590	687	786	880	972	1064	1166	1263	1467	1665	1867	2074	2274	2479
90"	542	627	733	832	936	1039	1140	1249	1352	1570	1784	2003	2222	2438	2659
96"	559	650	763	873	984	1090	1196	1313	1423	1647	1879	2109	2343	2576	2806
108"	605	706	834	956	1080	1200	1317	1444	1566	1814	2072	2327	2585	2841	3100
120"	648	770	903	1037	1203	1304	1437	1578	1709	1983	2261	2544	2833	3112	3432
132"	701	834	986	1134	1317	1426	1573	1722	1872	2173	2482	2788	3107	3416	3774
144"	747	892	1053	1210	1426	1536	1697	1853	2015	2341	2675	3009	3326	3667	4039
156"	807	963	1140	1315	1539	1661									
168"	860	1028	1214	1410	1651										
174"	908	1088	1286	1488	1748										

NOTE: SEE "PRODUCT CONFIGURATION SPECIFICATION" CHARTS ON PAGES 24-31 FOR ANY FABRIC AND SIZE RESTRICTIONS. CONTINUOUS CORD LOOP SYSTEM "REQUIRED" FOR SIZES WITHIN THE THICK BLACK LINE.

OPTIONS: NO EXTRA CHARGE	
<ul style="list-style-type: none"> <li>Color-Coordinated Rails</li> <li>Control Positions – left or right side of the shade (Exception: for Two-on-One Headrail, cords must be on opposite ends of the headrail)</li> <li>3" Extension Bracket and 1/2" Spacer Blocks – maximum of 3 spacer blocks per bracket</li> </ul>	<ul style="list-style-type: none"> <li>Hold Down Brackets</li> <li>Cut-Outs – up to 3" wide (see page 27 for details)</li> <li>Special Cord Lengths – standard cord is 40% of the height of the shade unless otherwise specified</li> <li>Hardware Color Override</li> </ul>

OPTIONS: EXTRA CHARGE	
<p>See "SIZE STANDARDS" for complete option details.</p> <ul style="list-style-type: none"> <li>Fabric-Wrapped Rail Option .....add \$36</li> <li>Top-Down &amp; Top-Down/Bottom-Up .....add \$124</li> <li>Continuous Cord Loop* .....add \$89</li> <li>– Top-Down/Bottom-Up* .....add \$213</li> </ul>	<ul style="list-style-type: none"> <li>Rectangular Shade and Arch – price as 2 separate shades; One Arch and One Rectangular</li> <li>TriLight Shades – see pages 32-37</li> <li>Angle Cut .....add \$199</li> </ul>

\*NOTE: FABRIC-WRAPPED RAILS ARE OPTIONAL FOR A SURCHARGE ON CONTINUOUS CORD LOOP, CORDLESS LIFT, CORDLESS LIFT & LOCK, AND MOTORIZED SHADES. COLOR-COORDINATED RAILS ARE AVAILABLE AT NO ADDITIONAL CHARGE.

See page 23 for motorization surcharges

**GROUP 11**

- 3/8" TRICELLA (H58)
- 3/4" TIFFANY (H25)
- 3/4" TRANQUILITY (H24)
- 3/4" OPULENCE BLACKOUT (H29)
- 3/4" SERENE FR BLACKOUT (H60)

WIDTH TO:	24"	30"	36"	42"	48"	54"	60"	66"	72"	84"	96"	108"	120"	132"	144"	174"
<b>HEIGHT TO:</b>																
36"	\$322	361	406	453	501	547	591	641	685	782	890	988	1094	1189	1285	1539
42"	347	390	444	499	552	605	653	706	763	873	988	1101	1212	1329	1440	1723
48"	377	430	494	554	609	671	728	793	857	982	1113	1244	1378	1502	1631	1959
54"	400	457	524	595	660	726	791	864	927	1069	1210	1359	1502	1644	1784	2141
60"	439	487	563	641	708	781	850	929	1007	1159	1315	1469	1624	1784	1932	2330
66"	457	515	597	676	761	835	913	996	1078	1244	1416	1584	1755	1918	2088	2511
72"	487	556	644	729	818	906	988	1083	1166	1352	1539	1720	1911	2091	2275	2741
78"	512	582	676	772	867	961	1049	1149	1244	1437	1638	1833	2036	2228	2426	2926
84"	533	613	715	818	915	1011	1106	1212	1315	1525	1732	1941	2157	2364	2578	3108
90"	563	651	763	865	973	1080	1186	1299	1407	1631	1854	2082	2311	2535	2765	3340
96"	582	676	793	908	1023	1134	1244	1366	1479	1713	1953	2194	2436	2679	2917	3524
108"	630	735	867	995	1122	1248	1370	1502	1628	1886	2155	2420	2687	2955	3223	3890
120"	674	800	938	1078	1251	1355	1493	1642	1778	2063	2351	2647	2946	3236	3570	4317
132"	729	867	1025	1180	1370	1483	1637	1791	1946	2259	2581	2900	3231	3552	3924	
144"	777	927	1095	1258	1483	1598	1764	1927	2097	2435	2781	3130	3459	3814	4200	
156"	839	1002	1186	1368	1601	1729										
168"	894	1069	1262	1467	1716											
174"	945	1133	1338	1548	1819											

NOTE: SEE "PRODUCT CONFIGURATION SPECIFICATION" CHARTS ON PAGES 24-31 FOR ANY FABRIC AND SIZE RESTRICTIONS. CONTINUOUS CORD LOOP SYSTEM "REQUIRED" FOR 3/4" SHEER, SEMI-SHEER AND TRIPLE CELL FABRIC SIZES WITHIN THE THICK BLACK LINE.

OPTIONS: NO EXTRA CHARGE	
<ul style="list-style-type: none"> <li>• Color-Coordinated Rails</li> <li>• Cordless Lift &amp; Lock (not available on 3/8" Tricella)</li> <li>• Cordless Lift &amp; Lock Two-On-One Headrail – price as 2 separate shades and add together (not available on 3/8" Tricella)</li> <li>• Cordless Lift &amp; Lock Three-On-One Headrail – price as 3 separate shades and add together (not available on 3/8" Tricella)</li> </ul>	<ul style="list-style-type: none"> <li>• Control Positions – left or right side of the shade (Exception: for Two-on-One Headrail, cords must be on opposite ends of the headrail)</li> <li>• 3" Extension Bracket and 1/2" Spacer Blocks – maximum of 3 spacer blocks per bracket</li> <li>• Hold Down Brackets</li> <li>• Cut-Outs – up to 3" wide (see page 27 for details)</li> <li>• Special Cord Lengths – standard cord is 40% of the height of the shade unless otherwise specified</li> <li>• Hardware Color Override</li> </ul>

OPTIONS: EXTRA CHARGE	
See "SIZE STANDARDS" for complete option details.	
<ul style="list-style-type: none"> <li>• Fabric-Wrapped Rail Option .....add \$36</li> <li>• Top-Down &amp; Top-Down/Bottom-Up .....add \$124</li> <li>• Continuous Cord Loop* .....add \$89                             <ul style="list-style-type: none"> <li>– Top-Down/Bottom-Up* .....add \$213</li> </ul> </li> <li>• Cordless Lift System* .....add \$124                             <ul style="list-style-type: none"> <li>– Two-On-One Headrail* price as 2 separate shades and add \$248 (not available in Top-Down/Bottom-Up or Two-Fabric Combination)</li> <li>– Three-On-One Headrail* price as 3 separate shades and add \$372 (not available in Top-Down/Bottom-Up or Two-Fabric Combination)</li> <li>– Top-Down/Bottom-Up* .....add \$248</li> </ul> </li> </ul>	<ul style="list-style-type: none"> <li>• Cordless Lift &amp; Lock                             <ul style="list-style-type: none"> <li>– Top-Down/Bottom-Up* .....add \$124</li> <li>– Premium Headrail Upgrade* .....add \$23 (Premium Headrail not available with Top-Down/Bottom-Up or TriLight)</li> </ul> </li> <li>• Cordless Extension Pole #40-0036-000 .....\$61</li> <li>• Rectangular Shade and Arch – price as 2 separate shades; One Arch and One Rectangular</li> <li>• TriLight Shades – see pages 32-37</li> <li>• Angle Cut .....add \$199</li> </ul>

\*NOTE: FABRIC-WRAPPED RAILS ARE OPTIONAL FOR A SURCHARGE ON CONTINUOUS CORD LOOP, CORDLESS LIFT, CORDLESS LIFT & LOCK, AND MOTORIZED SHADES. COLOR-COORDINATED RAILS ARE AVAILABLE AT NO ADDITIONAL CHARGE.

See page 23 for motorization surcharges

**GROUP 12 (Standard Rectangular)**

• 3/4" PEACEFUL (H96)

WIDTH TO:	24"	30"	36"	42"	48"	54"	60"	66"	72"	84"	96"	108"	120"	132"	144"	174"
<b>HEIGHT TO:</b>																
36"	\$384	432	485	542	598	653	706	766	819	934	1064	1182	1308	1423	1536	1842
42"	414	466	533	597	660	724	781	844	913	1044	1182	1317	1451	1591	1722	2061
48"	452	513	591	662	729	802	871	949	1025	1175	1331	1486	1649	1796	1950	2343
54"	478	547	627	710	789	869	947	1032	1110	1279	1447	1624	1796	1966	2132	2562
60"	524	582	674	766	846	933	1016	1111	1203	1386	1571	1757	1943	2132	2311	2788
66"	547	616	715	809	911	1000	1092	1191	1288	1486	1693	1893	2100	2295	2496	3002
72"	582	664	772	873	977	1085	1182	1295	1394	1617	1842	2058	2286	2500	2721	3276
78"	611	696	809	922	1039	1149	1255	1373	1486	1718	1960	2192	2436	2664	2901	3499
84"	637	733	857	977	1095	1209	1324	1451	1571	1824	2072	2321	2580	2825	3084	3719
90"	674	779	913	1034	1164	1292	1419	1554	1683	1950	2217	2491	2764	3032	3307	3995
96"	696	809	949	1087	1225	1355	1486	1635	1768	2049	2337	2624	2914	3204	3489	4216
108"	752	878	1039	1189	1341	1492	1638	1796	1946	2256	2578	2894	3215	3535	3855	4653
120"	807	957	1122	1288	1497	1621	1787	1964	2127	2468	2811	3165	3524	3869	4271	5162
132"	873	1039	1226	1412	1638	1775	1959	2143	2328	2703	3087	3468	3864	4248	4693	
144"	929	1110	1309	1506	1775	1911	2111	2304	2509	2910	3326	3742	4136	4561	5022	
156"	1003	1198	1419	1637	1916	2068										
168"	1069	1279	1509	1753	2054											
174"	1131	1354	1600	1851	2174											

NOTE: SEE "PRODUCT CONFIGURATION SPECIFICATION" CHARTS ON PAGES 24-31 FOR ANY FABRIC AND SIZE RESTRICTIONS. CONTINUOUS CORD LOOP SYSTEM "REQUIRED" FOR FABRIC SIZES WITHIN THE THICK BLACK LINE.

**OPTIONS: NO EXTRA CHARGE**

- **Color-Coordinated Rails**
- **Cordless Lift & Lock**
- **Cordless Lift & Lock Two-On-One Headrail** – price as 2 separate shades and add together
- **Cordless Lift & Lock Three-On-One Headrail** – price as 3 separate shades and add together
- **Control Positions** – left or right side of the shade (Exception: for Two-on-One Headrail, cords must be on opposite ends of the headrail)
- **3" Extension Bracket and 1/2" Spacer Blocks** – maximum of 3 spacer blocks per bracket
- **Hold Down Brackets**
- **Cut-Outs** – up to 3" wide (see page 27 for details)
- **Special Cord Lengths** – standard cord is 40% of the height of the shade unless otherwise specified
- **Hardware Color Override**

**OPTIONS: EXTRA CHARGE**

- See "SIZE STANDARDS" for complete option details.
- **Fabric-Wrapped Rail Option** .....add \$36
  - **Top-Down & Top-Down/Bottom-Up** .....add \$124
  - **Continuous Cord Loop\*** .....add \$89
    - **Top-Down/Bottom-Up\*** .....add \$213
  - **Cordless Lift System\*** .....add \$124
    - **Two-On-One Headrail\*** price as 2 separate shades and add \$248 (not available in Top-Down/Bottom-Up or Two-Fabric Combination)
    - **Three-On-One Headrail\*** price as 3 separate shades and add \$372 (not available in Top-Down/Bottom-Up or Two-Fabric Combination)
    - **Top-Down/Bottom-Up\*** .....add \$248
  - **Cordless Lift & Lock**
    - **Top-Down/Bottom-Up\*** .....add \$124
    - **Premium Headrail Upgrade\*** .....add \$23 (Premium Headrail not available with Top-Down/Bottom-Up or TriLight)
  - **Cordless Extension Pole #40-0036-000** .....\$61
  - **TriLight Shades** – see pages 32-37
  - **Angle Cut** .....add \$199

\*NOTE: FABRIC-WRAPPED RAILS ARE OPTIONAL FOR A SURCHARGE ON CONTINUOUS CORD LOOP, CORDLESS LIFT, CORDLESS LIFT & LOCK, AND MOTORIZED SHADES. COLOR-COORDINATED RAILS ARE AVAILABLE AT NO ADDITIONAL CHARGE.

See page 23 for motorization surcharges

**GROUP 13 – 2" HYBRID (Standard Rectangular)**

NOTE: A control option must be selected.

• 2" Hybrid Pleat – Semi-Opaque (HPF)

WIDTH TO:	18"	24"	28"	32"	36"	42"	48"	54"	60"	66"	72"	78"	84"	90"	96"	108"	120"
<b>HEIGHT TO:</b>																	
30"	\$262	273	299	312	324	363	384	413	434	522	551	584	613	636	666	795	929
36"	273	278	310	324	342	379	407	437	466	556	588	623	651	682	713	850	991
42"	278	303	322	337	358	397	427	460	489	590	623	662	690	724	758	906	1057
48"	287	312	333	353	374	416	475	487	517	620	660	699	733	768	802	965	1118
54"	292	324	344	365	386	432	487	505	542	655	692	738	774	814	850	1012	1179
61"	299	335	361	384	406	455	517	536	565	690	729	784	825	869	904	1072	1248
66"	324	358	388	413	432	473	521	552	593	724	761	816	855	904	945	1126	1308
73"	326	370	398	425	444	492	531	582	623	758	802	862	908	959	995	1184	
78"	379	429	460	494	529	575	625	683	733	784	834	888	938	993	1039	1237	
84"	388	439	475	506	542	595	651	713	761	816	871	929	979	1035	1088		
90"	398	455	489	529	559	618	671	736	793	848	906	970	1023	1081	1133		
96"	407	467	503	542	581	636	696	763	821	881	940	1005	1062	1122			
108"	443	513	558	604	651	720	793	871	940	1009	1083	1159					
120"	476	558	616	667	722	802	885	975	1058	1140	1223						

NOTE: SEE "PRODUCT CONFIGURATION SPECIFICATION" CHARTS ON PAGES 24-31 FOR ANY FABRIC AND SIZE RESTRICTIONS.

OPTIONS: NO EXTRA CHARGE	
<ul style="list-style-type: none"> <li>• Color-Coordinated Rails</li> <li>• Cordless Lift &amp; Lock</li> <li>• Cordless Lift &amp; Lock Two-On-One Headrail – price as 2 separate shades and add together</li> <li>• Cordless Lift &amp; Lock Three-On-One Headrail – price as 3 separate shades and add together</li> </ul>	<ul style="list-style-type: none"> <li>• Control Positions – left or right side of the shade (Exception: for Two-on-One Headrail, cords must be on opposite ends of the headrail)</li> <li>• 3" Extension Bracket and 1/2" Spacer Blocks – maximum of 3 spacer blocks per bracket</li> <li>• Hold Down Brackets</li> <li>• Hardware Color Override</li> </ul>

OPTIONS: EXTRA CHARGE	
<p>See "SIZE STANDARDS" for complete option details.</p> <ul style="list-style-type: none"> <li>• Fabric-Wrapped Rail Option .....add \$36</li> <li>• Top-Down &amp; Top-Down/Bottom-Up .....add \$124</li> <li>• Continuous Cord Loop* .....add \$89                             <ul style="list-style-type: none"> <li>– Top-Down/Bottom-Up* .....add \$213</li> </ul> </li> <li>• Cordless Lift System* .....add \$124                             <ul style="list-style-type: none"> <li>– Two-On-One Headrail* price as 2 separate shades and add \$248 (not available in Top-Down/Bottom-Up or Two-Fabric Combination)</li> <li>– Three-On-One Headrail* price as 3 separate shades and add \$372 (not available in Top-Down/Bottom-Up or Two-Fabric Combination)</li> <li>– Top-Down/Bottom-Up* .....add \$248</li> </ul> </li> </ul>	<ul style="list-style-type: none"> <li>• Cordless Lift &amp; Lock                             <ul style="list-style-type: none"> <li>– Top-Down/Bottom-Up* .....add \$124</li> <li>– Premium Headrail Upgrade* .....add \$23 (Premium Headrail not available with Top-Down/Bottom-Up or TriLight)</li> </ul> </li> <li>• Cordless Extension Pole #40-0036-000 .....\$61</li> <li>• TriLight Shades – see pages 32-37</li> </ul>

\*NOTE: FABRIC-WRAPPED RAILS ARE OPTIONAL FOR A SURCHARGE ON CONTINUOUS CORD LOOP, CORDLESS LIFT, CORDLESS LIFT & LOCK, AND MOTORIZED SHADES. COLOR-COORDINATED RAILS ARE AVAILABLE AT NO ADDITIONAL CHARGE.

See page 23 for motorization surcharges  
 Note: 2" Hybrid Pleat is Not Available with PowerWand Motorization

**GROUP 14 – 2" HYBRID (Standard Rectangular)**

NOTE: A control option must be selected.

• 2" Hybrid Pleat – Blackout (HPR)

WIDTH TO:	18"	24"	28"	32"	36"	42"	48"	54"	60"	66"	72"	78"	84"	90"	96"	108"	120"
<b>HEIGHT TO:</b>																	
30"	\$331	354	376	390	409	455	480	522	549	655	692	733	770	804	834	998	1166
36"	340	368	388	407	430	476	508	551	582	699	736	781	818	857	894	1071	1251
42"	349	381	402	429	448	499	533	581	618	740	779	832	869	913	952	1143	1327
48"	356	390	423	441	466	522	559	613	648	779	825	878	920	970	1011	1210	1407
54"	368	406	437	459	490	544	588	636	682	821	869	929	973	1025	1071	1278	1483
61"	376	425	452	480	505	570	618	671	706	869	919	986	1035	1090	1133	1352	1566
66"	406	448	492	519	542	591	636	697	745	904	965	1025	1080	1134	1189	1417	1644
73"	416	460	501	533	558	618	666	729	779	952	1007	1085	1140	1205	1253	1492	
78"	476	538	581	621	666	724	786	862	920	986	1046	1122	1184	1246	1309	1554	
84"	508	582	630	682	728	804	874	965	1035	1108	1184	1267	1336	1412	1486		
90"	559	639	694	747	804	880	968	1057	1136	1216	1306	1387	1472	1554	1635		
96"	598	701	772	839	904	1009	1113	1230	1327	1435	1539	1651	1753	1858			
108"	694	835	920	1011	1106	1239	1378	1527	1660	1794	1939	2081					
120"	765	934	1041	1154	1269	1435	1603	1782	1945	2105	2282						

NOTE: SEE "PRODUCT CONFIGURATION SPECIFICATION" CHARTS ON PAGES 24-31 FOR ANY FABRIC AND SIZE RESTRICTIONS.

OPTIONS: NO EXTRA CHARGE	
<ul style="list-style-type: none"> <li>• Color-Coordinated Rails</li> <li>• Cordless Lift &amp; Lock</li> <li>• Cordless Lift &amp; Lock Two-On-One Headrail – price as 2 separate shades and add together</li> <li>• Cordless Lift &amp; Lock Three-On-One Headrail – price as 3 separate shades and add together</li> </ul>	<ul style="list-style-type: none"> <li>• Control Positions – left or right side of the shade (Exception: for Two-on-One Headrail, cords must be on opposite ends of the headrail)</li> <li>• 3" Extension Bracket and 1/2" Spacer Blocks – maximum of 3 spacer blocks per bracket</li> <li>• Hold Down Brackets</li> <li>• Hardware Color Override</li> </ul>

OPTIONS: EXTRA CHARGE	
<p>See "SIZE STANDARDS" for complete option details.</p> <ul style="list-style-type: none"> <li>• Fabric-Wrapped Rail Option .....add \$36</li> <li>• Top-Down &amp; Top-Down/Bottom-Up .....add \$124</li> <li>• Continuous Cord Loop* .....add \$89                             <ul style="list-style-type: none"> <li>– Top-Down/Bottom-Up* .....add \$213</li> </ul> </li> <li>• Cordless Lift System* .....add \$124                             <ul style="list-style-type: none"> <li>– Two-On-One Headrail* price as 2 separate shades and add \$248 (not available in Top-Down/Bottom-Up or Two-Fabric Combination)</li> <li>– Three-On-One Headrail* price as 3 separate shades and add \$372 (not available in Top-Down/Bottom-Up or Two-Fabric Combination)</li> <li>– Top-Down/Bottom-Up* .....add \$248</li> </ul> </li> </ul>	<ul style="list-style-type: none"> <li>• Cordless Lift &amp; Lock                             <ul style="list-style-type: none"> <li>– Top-Down/Bottom-Up* .....add \$124</li> <li>– Premium Headrail Upgrade* .....add \$23 (Premium Headrail not available with Top-Down/Bottom-Up or TriLight)</li> </ul> </li> <li>• Cordless Extension Pole #40-0036-000 .....\$61</li> <li>• TriLight Shades – see pages 32-37</li> </ul>

\*NOTE: FABRIC-WRAPPED RAILS ARE OPTIONAL FOR A SURCHARGE ON CONTINUOUS CORD LOOP, CORDLESS LIFT, CORDLESS LIFT & LOCK, AND MOTORIZED SHADES. COLOR-COORDINATED RAILS ARE AVAILABLE AT NO ADDITIONAL CHARGE.

See page 23 for motorization surcharges  
 Note: 2" Hybrid Pleat is Not Available with PowerWand Motorization



**SIMPLICITY SURCHARGE AND OPTIONS**  
**EXTRA CHARGE – SPECIFY ON ORDER**  
**USE APPROPRIATE HONEYCOMB SHADE GRID FOR SHADE PRICE, THEN ADD EXTRA CHARGE(S) BELOW.**

- **Standard Simplicity Motorization** (Battery wand included in the price) .....add \$427 per shade
  - 5 Channel Remote Control (Black Part #CS5138 or White Part #CS5138W) .....add \$71 each
  - 14 Channel Remote – Available in White Only (Part #CS52136).....add \$107 each
  - 48" Extension Wire (Part #CS5133Z) .....add \$13 each
  - DC Power Supply (Part #CS5151).....add \$59 each
  
- **Simplicity Rechargeable Motorization** .....add \$427 per shade
  - 2-on-1 Headrail .....price as 2 separate shades
  - 5 Channel Remote Control (Black Part #CS5138 or White Part #CS5138W) .....add \$71 each
  - 14 Channel Remote – Available in White Only (Part #CS52136).....add \$107 each
  - 48" Extension Wire (Part #CS5133Z) .....add \$13 each
  - Solar Panel (Part #CS52096) .....add \$259 each
  - Plug-In Charger (Part #CS5199).....add \$54 each
  
- **Simplicity Rechargeable Top-Down/Bottom-Up** .....add \$427 per shade + TD/BU Surcharge \$124 per shade
  - 14 Channel Remote – Available in White Only (Part #CS52136).....add \$107 each
  - 48" Extension Wire (Part #CS5133Z) .....add \$13 each
  - Solar Panel (Part #CS52096) .....add \$259 each
  - Plug-In Charger (Part #CS5199).....add \$54 each
  
- **PowerWand™** .....add \$195 per shade
  - PowerWand™ Options (must be specified): **No Charge**
    - 1) Control Side (Left or Right)
    - 2) Wand Color (Black or White)
    - 3) Wand Length:
      - 1 foot (12")
      - 2 feet (24")
      - 3 feet (36")
      - 4 feet (48")
      - 5 feet (60")
  - Plug-In Charger (Part #CS5199).....add \$54 each

**Note: 2" Hybrid Pleat is Not Available with PowerWand™ Motorization**

**REMOTELIFT 2.0 SURCHARGE AND OPTIONS**

- **RemoteLift 2.0**.....add \$492
- **Remote Control #2984495100** .....add \$92
- **Wireless Wall Switch #2986350100**.....add \$128
- **RemoteLift Top-Down\***.....add \$77
- **Satellite Battery Pack #KIT2520** – select with wire length below:
  - **Satellite Battery Pack (15" Wire) #2989899000** .....add \$108
  - **Satellite Battery Pack (4' Wire) #2989900000**.....add \$117
  - **Satellite Battery Pack (10' Wire) #2989901000** .....add \$137
  - **Satellite Battery Pack (20' Wire) #2989902000** .....add \$151
- **18V DC Power Supply #7806000000** – select with wire length below:
  - **DC Power Supply (15" Wire) #2989899000** .....add \$158
  - **DC Power Supply (4' Wire) #2989900000** .....add \$161
  - **DC Power Supply (10' Wire) #2989901000** .....add \$169
  - **DC Power Supply (20' Wire) #2989902000** .....add \$174
- **Daisy Chain cable option requires DC Power Supply**
  - Daisy Chain Adapter** (Select with wire length below) #2989875000
    - (with 15" cable) #2989899000 .....add \$78
    - (with 4' cable) #2989900000 .....add \$89
    - (with 10' cable) #2989901000 .....add \$96
    - (with 20' cable) #2989902000 .....add \$105
- **Momenta** (must be submitted as part order)
  - **Momenta App Bridge Kit #2920072100** ..... add \$128 NET Cost
  - **Momenta Extender Kit #2920075100** .....add \$47 NET Cost

**REMOTELIFT 2.0 SPECIFICATIONS HAVE BEEN UPDATED. PLEASE VERIFY SIZE RESTRICTIONS ON PAGE 40 PRIOR TO ORDERING.**

# RECTANGULAR CONFIGURATION SPECIFICATIONS

NOTE: Use metal tape measure for all measurements. Measures to 1/8 inch.

## STANDARD CORDLOCK

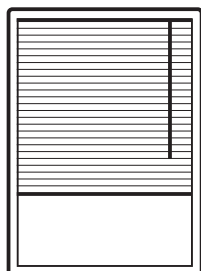

- Features snap-in bracket
- Headrail Color – color coordinated with fabric
- End mount brackets also available
- Standard cord length is 40% of the height of the shade unless otherwise specified

2" Hybrid Pleat is not available with standard cordlock.

STANDARD RECTANGULAR – SIZE STANDARDS							
	Honeycomb						
	All 3/8" Semi-Opaque Fabrics	All 3/8" Blackout Fabrics	All 3/4" Sheer and Semi-Sheer Fabrics	All 3/4" Semi-Opaque Fabrics*	All 3/4" Blackout Fabrics*	All 1/2" Double Cell Fabrics	All 3/8" Triple Cell Fabrics
Min. Width (net)*	8"	8"	8"	8"	8"	8"	8"
Max. Width	60"	60"	60"	60"	60"	60"	60"
Max. Width-End Mount	36"	36"	36"	36"	36"	36"	36"
Min. Height	6"	6"	6"	6"	6"	6"	6"
Max. Height*	144"	144"	144"	174"	174"	144"	120"
Max. Area (sq. ft.)	60	40	60	60	40	40	40

\* For shades under 12" widths, the maximum height is 80"

### FINISHED DIMENSIONS

Adjustments are taken from ordered dimensions.

Inside (IB) Mount	
Headrail unit	- 3/16"
Shade height	ordered height
Fabric width	- 3/8"
Outside (OB) Mount	
Headrail unit	ordered width
Shade height	ordered height
Fabric width	- 3/16"
End (EB) Mount	
Headrail unit	- 3/16"
Shade height	ordered height
Fabric width	- 3/8"
2 on 1 Headrail	
Gap between panels	- 1/4"

NOTE: Measurements may vary ± 1/8"

NOTE: Inside mount with hold down brackets deductions:

- Headrail -1/2"
- Fabric -5/8"
- Bottomrail -1/2"

### MOUNTING REQUIREMENTS

Use a metal tape measure for all measurements.

Inside (IB) Mount		3/8" Single Cell
Minimum mounting depth:		
Standard installation bracket		1"
Swivel bracket		1/2"
Minimum mounting depth, flush mount:		
Standard installation bracket		1-1/2"
Swivel bracket		1-1/8"
End mount bracket		1-1/8"
Outside (OB) Mount		3/8" Single Cell
Minimum flat vertical surface		
		5/8"
Inside (IB) Mount		3/4" Single, 1/2" Double, 3/8" Triple
Minimum mounting depth:		
Standard installation bracket		1-1/4"
Swivel bracket		1/2"
Minimum mounting depth, flush mount:		
Standard installation bracket		2-1/4"
Swivel bracket		2"
End mount bracket		2"
Outside (OB) Mount		3/4" Single, 1/2" Double, 3/8" Triple
Minimum flat vertical surface		
		1"

# RECTANGULAR CONFIGURATION SPECIFICATIONS

NOTE: Use metal tape measure for all measurements. Measures to 1/8 inch.

## STANDARD CORDLOCK – 2-ON-1 HEADRAIL (PRICE AS 2 SEPARATE SHADES)

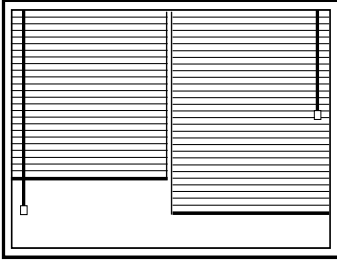

Cover patio doors and other large expanses by placing two independently operated shades side-by-side on the same headrail. Note: there will be a 1/4" minimum to a 1/2" maximum light gap between the two shades.

**Finished Dimensions & Mounting Requirements:**

see "Standard Rectangle" or "Continuous Cord" section.

NOTE: Measurements may vary ± 1/8"

STANDARD TWO-ON-ONE – SIZE STANDARDS							
	Honeycomb						
	All 3/8" Semi-Opaque Fabrics	All 3/8" Blackout Fabrics	All 3/4" Sheer and Semi-Sheer Fabrics	All 3/4" Semi-Opaque Fabrics*	All 3/4" Blackout Fabrics*	All 1/2" Double Cell Fabrics	All 3/8" Triple Cell Fabrics
Min. Width (per panel)	8"	8"	8"	8"	8"	8"	8"
Min. Width (overall)	16"	16"	16"	16"	16"	16"	16"
Max. Width (per panel)	60"	60"	60"	60"	60"	60"	60"
Max. Width (overall)	120"	120"	120"	120"	120"	120"	120"
Max. Width (end mount)	36"	36"	36"	36"	36"	36"	36"
Min. Height	6"	6"	6"	6"	6"	6"	6"
Max. Height	144"	144"	144"	174"	174"	144"	120"
Max. Area (sq. ft.)	60	40	60	60	40	40	60

Controls must be on opposite ends of the headrail. Standard cord length is 40% of the height of the shade unless otherwise specified.

# RECTANGULAR CONFIGURATION SPECIFICATIONS

NOTE: Use metal tape measure for all measurements. Measures to 1/8 inch.

## STANDARD CORDLOCK – TOP-DOWN OR TOP-DOWN/BOTTOM-UP

(2-cell fabric insert)

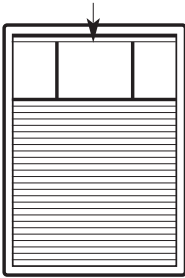

(2-cell fabric insert)

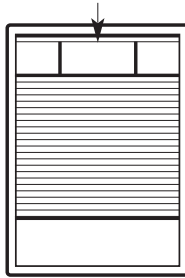

Conveniently open shades from the top down or from both top and bottom.

Top-Down/Bottom-Up features one Break-Away tassel per cordlock.

### Finished Dimensions & Mounting Requirements:

- See "Standard Rectangle" or "Cordless Lift" section.
- End mount brackets also available.

NOTE: Measurements may vary  $\pm 1/8"$

### NOTES:

- The standard control positions for TD/BU are:  
RIGHT operates the center moving rail and LEFT operates the bottomrail. REVERSE CONTROLS also are available (operate opposite as described above). Specify REVERSE CONTROLS when ordering.
- Standard cord length is 40% of the height of the shade unless otherwise specified.
- On top-down/bottom-up shades a fabric insert is standard. This is an extra two-cell fabric gasket attached to the top headrail and acts as a seal to eliminate light leakage between the headrail and center rail when the shade is closed.

### TOP-DOWN – SIZE STANDARDS

	Honeycomb						
	All 3/8" Semi-Opaque Fabrics	All 3/8" Blackout Fabrics	All 3/4" Sheer and Semi-Sheer Fabrics	All 3/4" Semi-Opaque Fabrics	All 3/4" Blackout Fabrics	All 1/2" Double Cell Fabrics	All 3/8" Triple Cell Fabrics
Min. Width (net)*	10"	10"	10"	10"	10"	10"	10"
Max. Width	60"	60"	60"	60"	60"	60"	60"
Max. Width-End Mount	36"	36"	36"	36"	36"	36"	36"
Min. Height	6"	6"	6"	6"	6"	6"	6"
Max. Height*	144"	144"	144"	174"	174"	144"	120"
Max. Area (sq. ft.)	60	40	60	60	40	40	60

\* For shades under 12" widths, the maximum height is 80"

### TOP-DOWN/BOTTOM-UP – SIZE STANDARDS

	Honeycomb						
	All 3/4" Semi-Opaque Fabrics	All 3/8" Blackout Fabrics	All 3/4" Sheer and Semi-Sheer Fabrics	All 3/4" Semi-Opaque Fabrics	All 3/4" Blackout Fabrics	All 1/2" Double Cell Fabrics	All 3/8" Triple Cell Fabrics
Min. Width (net)*	10"	10"	10"	10"	10"	10"	10"
Max. Width	72"	72"	72"	72"	72"	72"	72"
Max. Width-End Mount	36"	36"	36"	36"	36"	36"	36"
Min. Height	6"	6"	6"	6"	6"	6"	6"
Max. Height*	108"	108"	108"	108"	108"	108"	108"
Max. Area (sq. ft.)	48	40	48	48	40	40	48

\* For shades under 12" widths, the maximum height is 80"

**Cut-outs are not available on Top-Down or Top-Down/Bottom-Up shades.**

# RECTANGULAR CONFIGURATION SPECIFICATIONS

NOTE: Use metal tape measure for all measurements. Measures to 1/8 inch.

## STANDARD CORDLOCK – TWO-FABRIC COMBINATION (PRICE AS 2 SEPARATE SHADES)

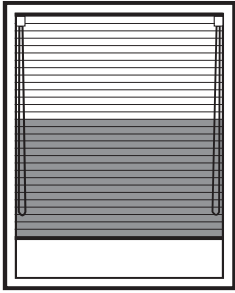

Headrail, Middle Rail, and Bottomrail will coordinate with the bottom fabric unless otherwise specified.

Combines two fabrics in the same shade for function, beauty and total versatility. Consider a sheer shade to filter light, combined with a blackout shade for maximum darkness. Easily adjust shade to cover the window with one fabric or with some of each fabric. Standard cord length is 40% of the height of the shade unless otherwise specified.

Shade features one Break-Away tassel per cordlock.

**Finished Dimensions & Mounting Requirements:**

- See "Standard Rectangle" or "Cordless Lift" section.
- End mount brackets also available.

NOTE: Measurements may vary  $\pm 1/8$ "

### TWO-FABRIC COMBO – SIZE STANDARDS

	Honeycomb					
	All 3/4" Semi-Opaque Fabrics	All 3/4" Sheer and Semi-Sheer Fabrics	All 3/4" Semi-Opaque Fabrics	All 3/4" Blackout Fabrics	All 1/2" Double Cell Fabrics	All 3/8" Triple Cell Fabrics
Min. Width (net)*	10"	10"	10"	10"	10"	10"
Max. Width	72"	72"	72"	72"	60"	60"
Max. Width-End Mount	36"	36"	36"	36"	36"	36"
Min. Height	6"	6"	6"	6"	6"	6"
Max. Height*	96"	96"	96"	96"	90"	90"
Max. Area (sq. ft.)	48	48	48	40	40	40

\* For shades under 12" widths, the maximum height is 80"

Not available with 3/8" single cell fabrics, SoftStyle or 2" Hybrid Pleat fabrics.

## CUT-OUTS

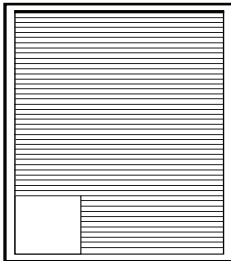

The portion of the shade above the cut-out will not stack tightly when the shade is raised.

**Available on standard cordlock, continuous cord loop and RemoteLift bottom-up shades only.**

**Not available on 2" Hybrid Pleat shades.**

### CUT-OUTS - SIZE STANDARDS

Min. Cut-out Width	1/8"
Max. Cut-out Width	3"
Min. Shade Width	12"
Max. Shade Width	120"
Min. Shade Height	12"
Max. Shade Height	120"



# RECTANGULAR CONFIGURATION SPECIFICATIONS

NOTE: Use metal tape measure for all measurements. Measures to 1/8 inch.

## CORDLESS LIFT SYSTEM

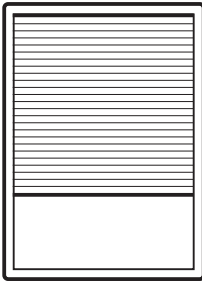

Cordless Lift System easily lifts and lowers from color-coordinated bottomrail. No lift cord is necessary.



- All Cordless shades can be ordered with the fabric covered headrail and bottomrail **for a surcharge**, or with the color coordinated non-wrapped rails at **no additional charge**. Must be specified when order is placed.
- Cordless honeycomb shades come with a color-coordinated textured handle pre-inserted, a clear textured handle or clear plastic insert are optional.  
Shades over 42" in width will have 2 handles. Single handle available, must be selected during order entry.
- Cut-outs are not available on Cordless Lift shades.
- Top Down Bottom Up shades are now available with white striker plates and magnet caps when shades are ordered with fabric-wrapped rails. Zinc striker plates and magnets comes standard on shades ordered with color-coordinated rails.  
Striker plate & magnet placement:  
Shades under 42" Wide – one magnet on each end of the shade  
Shades 42" - 78" wide – one magnet on each end of the shade and one offset 3" from the center cord  
Shades 78" - 96" wide – one magnet on each end of the shade and one in the center of the shade.  
Shades over 96" wide – one magnet on each end of the shade and one at 3" to the left and right of the center routes.

CORDLESS LIFT – SIZE STANDARDS		
	Honeycomb	2" Hybrid Pleat
	All Honeycomb Fabrics *	All Fabrics
Min. Width (net)	16"	16"
Max. Width	120"	120"
Max. Width – End Mount	48"	42"
Min. Height	12"	12"
Max. Height	84"	84"
Max Area (sq. ft.)	70	60

\* Cordless Lift not available with any 3/8" blackout or triple cell fabrics

CORDLESS LIFT TOP-DOWN/BOTTOM-UP – SIZE STANDARDS		
	Honeycomb	2" Hybrid Pleat
	All Honeycomb Fabrics *	All Fabrics
Min. Width (net)	16"	16"
Max. Width	120"	120"
Max. Width – End Mount	48"	42"
Min. Height	12"	12"
Max. Height	84"	84"
Max Area (sq. ft.)	70	60

\* Cordless Lift Top-Down/Bottom-Up is not available with any 3/8" blackout or triple cell fabrics

CORDLESS LIFT TWO-FABRIC COMBO – SIZE STANDARDS	
	All Honeycomb Fabrics *
Min. Width (net)	16"
Max. Width	84"
Max. Width – End Mount	36"
Min. Height	12"
Max. Height	84"
Max Area (sq. ft.)	42

\* Cordless Lift Two-Fabric Combination is not available with any 3/8", 3/8" blackout, 1/2" double cell, triple cell, or 2" Hybrid Pleat fabrics

Note: Cut-outs are not available on Cordless Lift shades.

CORDLESS TWO-ON-ONE – SIZE STANDARDS		
	Honeycomb	2" Hybrid Pleat
	All Honeycomb Fabrics *	All Fabrics
Min Width (per panel)	16"	16"
Min Width (overall)	32"	32"
Max Width (per panel)	120"	100"
Max Width (overall)	174"	120"
Min Height	12"	12"
Max Height	84"	84"
Max Area (per panel) (Sq/Ft)	70	60

\* Two-On-One Headrail is not available in Top-Down/Bottom-Up, Two-Fabric Combo, 3/8" blackout or triple cell fabrics

Note: End mount not available.

CORDLESS THREE-ON-ONE – SIZE STANDARDS		
	Honeycomb	2" Hybrid Pleat
	All Honeycomb Fabrics *	All Fabrics
Min Width (per panel)	16"	16"
Min Width (overall)	48"	48"
Max Width (per panel)	120"	120"
Max Width (overall)	174"	174"
Min Height	12"	12"
Max Height	84"	84"
Max Area (per panel) (Sq/Ft)	70	60

\* Three-On-One Headrail is not available in Top-Down/Bottom-Up, Two-Fabric Combo, 3/8" blackout or triple cell fabrics

Note: End mount not available.

## FINISHED DIMENSIONS

Adjustments are taken from ordered dimensions.

	Honeycomb	2" Hybrid Pleat
<b>Inside (IB) Mounts</b>		
Headrail unit	- 1/4"	- 1/4"
Shade height	ordered height	ordered height
Fabric width	- 3/8"	- 3/8"
<b>End (EB) Mounts</b>		
Headrail unit	- 1/2"	- 1/2"
Shade height	ordered height	ordered height
Fabric width	- 5/8"	- 5/8"
<b>Outside (OB) Mount</b>		
Headrail unit	ordered width	ordered width
Shade height	ordered height	ordered height
Fabric width	- 1/8"	- 1/8"
<b>2-on-1 &amp; 3-on-1 Headrail</b>		
Gap between panels	-1/4"	-1/4"

NOTE: Measurements may vary ± 1/8"

## MOUNTING REQUIREMENTS

Use a metal tape measure for all measurements.

	Honeycomb	2" Hybrid Pleat
<b>Inside (IB) &amp; End (EB) Mounts</b>		
Minimum mounting depth	3/4"	3/4"
Minimum mounting depth, flush mount:	2-1/8"	2-1/8"
<b>Outside (OB) Mount</b>		
Minimum flat vertical surface	1-1/2"	1-1/2"

NOTE: Inside mount with hold down brackets deductions:  
Headrail -1/2"  
Fabric -5/8"  
Bottomrail -1/2"

# RECTANGULAR CONFIGURATION SPECIFICATIONS

NOTE: Use metal tape measure for all measurements. Measures to 1/8 inch.

## CORDLESS LIFT & LOCK

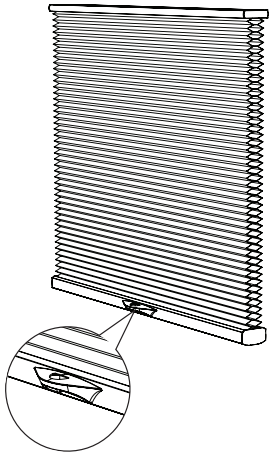

Press a button on the bottomrail to lift and lower the shade. Release the button to securely lock the shade into place.

No exposed cords on bottom up shades. Lift cords on Top-Down/Bottom-Up are on the far sides of the shade. Child-safe option.

All Cordless Lift & Lock shades can be ordered with the fabric covered headrail and bottomrail for a surcharge, or with the color coordinated non-wrapped rails at no additional charge. Must be specified when order is placed.

CORDLESS LIFT & LOCK – SIZE STANDARDS			
	Honeycomb		2" Hybrid Pleat
	Sheer, Semi-Sheer & Semi-Opaque Honeycomb Fabrics*	All Blackout Honeycomb Fabrics*	All Fabrics
Min. Width (net)	9-1/2"	9-1/2"	9-1/2"
Max. Width	84"	84"	84"
Max. Width – End Mount	48"	48"	48"
Min. Height	12"	12"	12"
Max. Height	84"	84"	84"
Max Area (sq. ft.)	49	49	49

\* Cordless Lift & Lock is not available with any 3/8" or triple cell fabrics

CORDLESS LIFT & LOCK TOP-DOWN/BOTTOM-UP – SIZE STANDARDS			
	Honeycomb		2" Hybrid Pleat
	All Sheer, Semi-Sheer & Semi-Opaque Honeycomb Fabrics*	All Blackout Honeycomb Fabrics*	All Fabrics
Min. Width (net)	16"	16"	16"
Max. Width	84"	84"	84"
Max. Width – End Mount	48"	48"	42"
Min. Height	12"	12"	12"
Max. Height	84"	84"	84"
Max Area (sq. ft.)	49	49	49

\* Cordless Lift & Lock is not available with any 3/8" or triple cell fabrics

Top-Down/bottom-Up Lift & Lock shades under 42" will have one magnet in the middle.

Shades over 42" will have one magnet in the middle, and one approximately 3" from each end to provide better closure between the middle rail and top rail.

Cordless Lift & Lock shades can be ordered with the Premium headrail for a surcharge. Premium headrail option is not available with Top-Down/Bottom-Up or TriLight.

CORDLESS LIFT & LOCK TWO-ON-ONE & THREE-ON-ONE – SIZE STANDARDS			
	All Sheer, Semi-Sheer & Semi-Opaque Honeycomb Fabrics*	All Blackout Honeycomb Fabrics*	2" Hybrid Pleat
<b>Two-on-One</b>			
Min. Width (net - per panel)	9.5"	9.5"	9.5"
Max. Width (per panel)	84"	84"	84"
Max. Width (overall)	168"	168"	168"
<b>Three-on-One</b>			
Min. Width (net - per panel)	9.5"	9.5"	9.5"
Max. Width (per panel)	84"	84"	84"
Max. Width (overall)	168"	168"	168"
Min. Height	12"	12"	12"
Max. Height	84"	84"	84"
Max Area (per panel) (sq. ft.)	49	49	49

\* Cordless Lift & Lock not available with any 3/8" or triple cell fabrics.

Note: End mount not available with 2-on-1 or 3-on-1

## FINISHED DIMENSIONS – STANDARD

Adjustments are taken from ordered dimensions.

	Honeycomb	2" Hybrid Pleat
<b>Inside (IB) Mounts</b>		
Headrail unit (includes end caps)	- 1/4"	- 1/4"
Shade height	ordered height	ordered height
Fabric width	- 3/8"	- 3/8"
<b>End (EB) Mounts</b>		
Headrail unit (includes end caps)	- 1/2"	- 1/2"
Shade height	ordered height	ordered height
Fabric width	- 5/8"	- 5/8"
<b>Outside (OB) Mount</b>		
Headrail unit (includes end caps)	ordered width	ordered width
Shade height	ordered height	ordered height
Fabric width	- 1/8"	- 1/8"
<b>2-on-1 &amp; 3-on-1 Headrail</b>		
Gap between panels	-1/4"	-1/4"

NOTE: Measurements may vary ± 1/8"

## MOUNTING REQUIREMENTS

Use a metal tape measure for all measurements.

	Honeycomb	2" Hybrid Pleat
<b>Standard Headrail</b>		
<b>Inside (IB) Mount</b>		
Minimum mounting depth	1-1/4"	1-1/4"
Minimum mounting depth, flush mount:	2-1/4"	2-1/4"
<b>End (EB) Mount</b>		
Minimum flat vertical surface	2"	2"
<b>Outside (OB) Mount</b>		
Minimum flat vertical surface	1"	1"

NOTE: Inside mount with hold down brackets deductions:  
 Headrail -1/2"  
 Fabric -5/8"  
 Bottomrail -1/2"

Use a metal tape measure for all measurements.

	Honeycomb	2" Hybrid Pleat
<b>with Premium Rail option</b>		
<b>Inside (IB) Mounts</b>		
Minimum mounting depth	3/4"	3/4"
Minimum mounting depth, flush mount:	2-1/8"	2-1/8"
<b>Outside (OB) Mount</b>		
Minimum flat vertical surface	1-1/2"	1-1/2"

# RECTANGULAR CONFIGURATION SPECIFICATIONS

NOTE: Use metal tape measure for all measurements. Measures to 1/8 inch.

## CONTINUOUS CORD LOOP SYSTEM

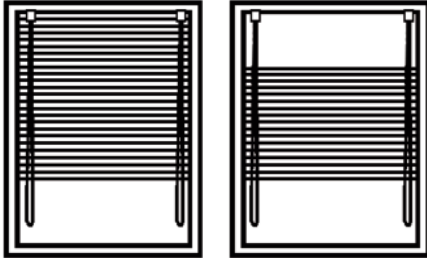

Continuous cord loop easily lifts any shade – even large or hard-to-reach – and stops the shade exactly where you want. No more tangled cords!

- All continuous cord loop shades can be ordered with the fabric covered headrail and bottomrail **for a surcharge**, or with the color coordinated non-wrapped rails at **no additional charge. Must be specified** when order is placed.
- On top-down/bottom-up Honeycomb shades, a fabric insert is standard (does not apply to Hybrid Pleat). This is an extra two-cell fabric gasket attached to the top headrail and acts as a seal to eliminate light leakage between the headrail and center rail when the shade is closed.

CONTINUOUS CORD LOOP – SIZE STANDARDS								
	Honeycomb							2" Hybrid Pleat
	All 3/8" Semi-Opaque Fabrics	All 3/8" Blackout Fabrics	All 3/4" Sheer and Semi-Sheer Fabrics	All 3/4" Semi-Opaque Fabrics*	All 3/4" Blackout Fabrics*	All 1/2" Double Cell Fabrics	All 3/8" Triple Cell Fabrics	All Fabrics
Min. Width (net)*	18"	18"	18"	18"	18"	18"	18"	18"
Max. Width	144"	144"	174"	174"	144"	144"	142"	120"
Max. Width – End Mount	48"	48"	48"	48"	48"	48"	48"	42"
Min. Height	6"	6"	6"	6"	6"	6"	6"	12"
Max. Height*	96"	96"	144"	144"	144"	144"	120"	120"
Max. Area (sq. ft.)	90	80	150	150	100	80	80	60

\* Radiance Semi-Opaque & Blackout => Max Width 120"

CONTINUOUS CORD LOOP TWO-ON-ONE – SIZE STANDARDS								
	Honeycomb							2" Hybrid Pleat
	All 3/8" Semi-Opaque Fabrics	All 3/8" Blackout Fabrics	All 3/4" Sheer and Semi-Sheer Fabrics	All 3/4" Semi-Opaque Fabrics*	All 3/4" Blackout Fabrics*	All 1/2" Double Cell Fabrics	All 3/8" Triple Cell Fabrics	2" Hybrid Pleat
Min. Width (per panel)	18"	18"	18"	18"	18"	18"	18"	18"
Min. Width (overall)	36"	36"	36"	36"	36"	36"	36"	36"
Max. Width (per panel)	144"	144"	144"	144"	144"	144"	142"	102"
Max. Width (overall)	174"	174"	174"	174"	174"	174"	174"	120"
Min. Height	6"	6"	6"	6"	6"	6"	6"	12"
Max. Height	96"	96"	144"	144"	144"	144"	120"	120"
Max. Area (sq. ft.)	90	80	150	150	100	80	80	60

Note: End mount not available.

\* Radiance Semi-Opaque & Blackout => Max Width 120"

CONTINUOUS CORD LOOP TOP-DOWN/BOTTOM-UP – SIZE STANDARDS								
	Honeycomb							2" Hybrid Pleat
	All 3/8" Semi-Opaque Fabrics	All 3/8" Blackout Fabrics	All 3/4" Sheer and Semi-Sheer Fabrics	All 3/4" Semi-Opaque Fabrics*	All 3/4" Blackout Fabrics*	All 1/2" Double Cell Fabrics	All 3/8" Triple Cell Fabrics	2" Hybrid Pleat
Min. Width (net)*	24"	24"	24"	24"	24"	24"	24"	24"
Max. Width	144"	144"	144"	144"	144"	144"	142"	120"
Max. Width – End Mount	48"	48"	48"	48"	48"	48"	48"	42"
Min. Height	8"	8"	8"	8"	8"	8"	8"	12"
Max. Height*	96"	96"	144"	144"	144"	144"	120"	120"
Max. Area (sq. ft.)	90	80	150	150	100	80	80	60

\* Radiance Semi-Opaque & Blackout => Max Width 120"

Right control operates the center moving rail; left control operates the bottomrail.  
Reverse controls are available.

NOTE: Inside mount with hold down brackets deductions:  
Headrail -1/2"  
Fabric -5/8"  
Bottomrail -1/2"

# RECTANGULAR CONFIGURATION SPECIFICATIONS

NOTE: Use metal tape measure for all measurements. Measures to 1/8 inch.

## CONTINUOUS CORD LOOP SYSTEM

### FINISHED DIMENSIONS

Adjustments are taken from ordered dimensions.

	Honeycomb	2" Hybrid Pleat*
<b>Inside (IB) Mount</b>		
Headrail unit	- 1/4"	- 1/4"
Shade height	ordered height	ordered height
Fabric width	- 3/8"	- 5/8"
<b>End (EB) Mounts</b>		
Headrail unit	- 1/2"	- 1/2"
Shade height	ordered height	ordered height
Fabric width	- 5/8"	- 7/8"
<b>Outside (OB) Mount</b>		
Headrail unit	ordered width	ordered width
Shade height	ordered height	ordered height
Fabric width	- 1/8"	- 3/8"

\*An extra 1/4" deduction will be taken from the fabric with the Top-Down/Bottom-Up option for Hybrid Pleat

NOTE: Measurements may vary ± 1/8"

### FINISHED DIMENSIONS – 2 ON 1

Adjustments are taken from ordered dimensions.

	Honeycomb	2" Hybrid Pleat
<b>Inside (IB) Mount</b>		
Headrail unit	- 1/4"	- 1/4"
Shade height	ordered height	ordered height
Fabric width (includes gap deduction)	- 5/8"	- 7/8"
<b>Outside (OB) Mount</b>		
Headrail unit	ordered width	ordered width
Shade height	ordered height	ordered height
Fabric width	- 1/8"	- 3/8"
<b>2 on 1 Headrail</b>		
Gap between panels	- 1/4"	- 1/4"

### CORD LOOP DROP

SHADE HEIGHT	CORD LOOP DROP
up to 18"	18" loop
18" to 42"	24" loop
42-1/8" - 54"	36" loop
54-1/8" - 72"	48" loop
72-1/8" - 90"	60" loop
90-1/8" - 110"	72" loop
110-1/8" - 130"	96" loop
130-1/8" - 144"	120" loop

### MOUNTING REQUIREMENTS

Use a metal tape measure for all measurements.

	Honeycomb	2" Hybrid Pleat
<b>Inside (IB) Mounts</b>		
Minimum mounting depth	3/4"	3/4"
Minimum mounting depth, flush mount:	2-1/8"	2-1/8"
<b>Outside (OB) Mount</b>		
Minimum flat vertical surface	1-1/2"	1-1/2"

NOTE: Inside mount with hold down brackets deductions:

Headrail -1/2"

Fabric -5/8"

Bottomrail -1/2"

---

## FEATURES & BENEFITS

---



- The beautiful combination of a sheer pleated shade on top and honeycomb or 2" Hybrid Pleat shade on the bottom provides maximum versatility in a single window covering.
- Wide array of color options from whites, neutrals, and muted tones to bold colors and exclusive prints.
- Four sheer pleated styles in multiple colors to meet most decorating tastes.
- Semi-opaque and blackout fabrics are available in multiple sizes, providing a choice for every window size and desired light and privacy control.
- Honeycomb fabric provides superior insulation for reduced heating and cooling bills. It also absorbs sound, making rooms more comfortable.
- The continuous cord loop option lifts any shade – even large or hard-to-reach – and positions it exactly where you want without any dangling cords.
- The Cordless and Cordless Lift & Lock option provide safe, simple operation by raising and lowering the shade using handles instead of cords. Ideal in homes with children and pets.

---

## SELECTING A TRILIGHT SHADE

---

1. Choose a fabric, cell size and color for the bottom shade. Note: TriLight Shades are not available with 3/8" single cell, 3/4" sheer/semi-sheer or triple cell fabrics.
2. Choose a sheer pleated fabric for the top shade. See Sheer Pleated Color Chart.
3. Refer to the honeycomb and 2" Hybrid Pleat price grids on pages 9-22 to determine your bottom shade price.
4. Refer to the sheer pleated grids on page 34 to find your top shade price. Add the bottom shade, sheer pleated and control option prices together to determine your final price.
  - TriLight Shades are available as standard rectangle only.
  - Continuous cord loop system – right operates the middle rail; left operates the bottomrail. Reverse controls are available; grouped controls are NOT available.



## SHEER PLEATED COLOR CHART

Sheer Pleated Price Group A		
Style Name	Color #	Color Name
Nova Sheer	P33-824	Blush
Nova Sheer	P33-820	Bridal White
Nova Sheer	P33-823	Crème
Nova Sheer	P33-821	Glacier White
Nova Sheer	P33-822	Light Lemon
Nova Sheer	P33-825	Tea

Sheer Pleated Price Group B		
Style Name	Color #	Color Name
Carousel Sheer	P32-804	Blush
Carousel Sheer	P32-800	Bridal White
Carousel Sheer	P32-803	Crème
Carousel Sheer	P32-801	Glacier White
Carousel Sheer	P32-802	Light Lemon

Sheer Pleated Price Group A		
Style Name	Color #	Color Name
Willa Sheer	P05-506	Bisque
Willa Sheer	P05-508	Chocolate
Willa Sheer	P05-504	Crystal
Willa Sheer	P05-502	Heirloom
Willa Sheer	P05-501	Ice
Willa Sheer	P05-507	Latte
Willa Sheer	P05-505	Light Taupe
Willa Sheer	P05-500	Snow White
Willa Sheer	P05-503	Soft Ivory
Willa Sheer	P05-509	Twilight

Sheer Pleated Price Group B		
Style Name	Color #	Color Name
Lyssa Sheer	P04-405	Blush
Lyssa Sheer	P04-400	Bridal White
Lyssa Sheer	P04-402	Crème
Lyssa Sheer	P04-401	Glacier White
Lyssa Sheer	P04-403	Light Lemon
Lyssa Sheer	P04-407	Tea

SHEER PLEATED MAXIMUM WIDTHS		% UV BLOCKAGE
Carousel	96"	60
Lyssa	96"	50
Nova	96"	60
Willa	83"	60





Determine the top shade price by using the charts below. Add the sheer pleated, bottom shade, and control option prices together to determine your final price.

**GROUP A (Sheer Pleated)**

- Nova Sheer (96")
- Willa Sheer (83")

WIDTH TO:	24"	30"	36"	42"	48"	54"	60"	66"	72"	84"	96"
<b>HEIGHT TO:</b>											
36"	\$82	91	100	114	126	137	147	156	169	193	216
42"	87	98	108	126	137	147	160	176	186	213	241
48"	92	103	119	133	147	160	176	190	202	236	262
54"	98	108	128	144	156	174	190	202	222	252	287
60"	101	117	137	151	167	186	200	218	239	275	308
66"	107	126	146	160	183	197	215	238	253	291	333
72"	114	131	151	174	193	211	230	250	271	310	353
78"	119	138	160	181	202	223	245	264	289	333	376
84"	124	146	165	190	213	236	255	280	301	345	395
90"	130	151	176	197	223	246	271	294	321	370	418
96"	133	156	184	207	236	255	284	308	335	384	437

**GROUP B (Sheer Pleated)**

- Carousel Sheer (96")
- Lyssa Sheer (96")

WIDTH TO:	24"	30"	36"	42"	48"	54"	60"	66"	72"	84"	96"
<b>HEIGHT TO:</b>											
36"	\$96	107	124	137	151	163	179	190	206	232	262
42"	101	115	133	151	163	179	195	211	225	257	291
48"	108	126	144	160	179	195	211	229	246	284	321
54"	115	133	153	174	190	209	229	248	264	307	347
60"	124	142	163	184	200	225	245	264	287	331	374
66"	131	151	176	195	218	241	261	285	307	353	402
72"	137	158	184	207	232	255	280	305	330	379	430
78"	144	165	192	216	246	271	296	322	349	402	457
84"	149	176	200	229	255	284	310	338	365	420	478
90"	156	184	211	241	271	299	326	356	386	446	505
96"	160	190	222	252	284	310	342	374	404	467	531

**OPTIONS: NO EXTRA CHARGE**

- Extension Brackets
- End Mount Brackets
- Hold Down Brackets
- Spacer Blocks
- Special Cord Loop Length
- Color-Coordinated Rails

**CONTROL OPTIONS**

A CONTROL OPTION MUST BE SELECTED.

- Cordless Lift & Lock System.....No Charge
- Cordless Lift System.....add \$124
- Continuous Cord Loop .....add \$89
- Fabric-Wrapped Rail option .....add \$36

# TRILIGHT CONFIGURATION SPECIFICATIONS



## TRILIGHT – CONTINUOUS CORD LOOP

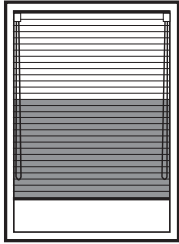

Features same headrail as continuous cord loop system.

**Options:**

- Color-Coordinated painted rails - no extra charge
  - Headrail, bottomrail, and middle rail, end caps, cord loops, and handles will color-coordinate to the bottom (honeycomb) fabric
- Fabric wrapped rails - surcharge applies
  - fabric wrapped headrail, bottomrail, and middle rail, end caps, cord loops, and handles will coordinate to the bottom (honeycomb) fabric
- Headrail can be fabric wrapped to match the top (sheer) fabric - surcharge applies
  - Rails, end caps, cord loops, and handles will color-coordinate to the bottom (honeycomb) fabric

**NOTES:**

- Right loop control operates the middle rail, left loop control operates the bottomrail.
- TriLight is not available with 3/8" single cell, 3/4" Sheer, 3/4" Semi-Sheer, or Triple Cell fabrics

**Cut-outs are not available on TriLight Shades.**

CONTINUOUS CORD LOOP SIZE STANDARDS				
	Honeycomb			2" Hybrid Pleat
	All 3/4" Semi-Opaque Fabrics	All 3/4" Blackout Fabrics	All 1/2" Double Cell Fabrics	All Fabrics
Min. Width (net)	24"	24"	24"	24"
Max. Width*	83" - 96"	83" - 96"	83" - 96"	83" - 96"
Max. Width-End Mount	48"	48"	48"	42"
Min. Height	12"	12"	12"	12"
Max. Height	96"	96"	96"	96"
Max. Area (sq. ft.)	64	50	50	60

\* The bottom panel fabric width can be reduced by the ordered sheer fabric (top panel), if the sheer max width is less than the bottom panel max width.

### FINISHED DIMENSIONS

Adjustments are taken from ordered dimensions.  
Measurements may vary +/- 1/8".

	Honeycomb	2" Hybrid Pleat
<b>Inside (IB) Mounts</b>		
Headrail unit	- 1/4"	- 1/4"
Shade height	ordered height	ordered height
Fabric width	- 3/8"	- 7/8"
<b>End (EB) Mounts</b>		
Headrail unit	- 1/2"	- 1/2"
Shade height	ordered height	ordered height
Fabric width	- 5/8"	- 1-1/8"
<b>Outside (OB) Mount</b>		
Headrail unit	ordered width	ordered width
Shade height	ordered height	ordered height
Fabric width	- 1/8"	- 5/8"

### MOUNTING REQUIREMENTS

Use a metal tape measure for all measurements.

	Honeycomb	2" Hybrid Pleat
<b>Inside (IB) &amp; End (EB) Mounts</b>		
Minimum mounting depth	3/4"	3/4"
Minimum mounting depth, flush mount:	2-1/8"	2-1/8"
<b>Outside (OB) Mount</b>		
Minimum flat vertical surface	1-1/2"	1-1/2"

NOTE: Inside mount with hold down brackets deductions:

- Headrail -1/2"
- Fabric -5/8"
- Bottomrail -1/2"

### FABRIC AND HARDWARE STACKING

- **HONEYCOMB CONTINUOUS CORD LOOP TRILIGHT:** Take 2-1/2" for rails, plus 1/8" for each 12" of honeycomb shade height, plus 1/8" for each 12" of pleated shade height.
- **2" HYBRID PLEAT CONTINUOUS CORD LOOP TRILIGHT:** Take 2-1/2" for rails, plus 1/4" for each 12" of shade height, plus 1/8" for each 12" of pleated shade height. Allow 1-1/2" for fabric fold over.

# TRILIGHT CONFIGURATION SPECIFICATIONS



## TRILIGHT – CORDLESS

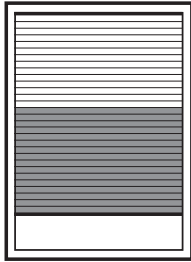

Sheer pleated lifts and lowers from the middle rail. Honeycomb and 2" Hybrid Pleat lift and lower from the bottomrail. No lift cords are necessary.

Options:

- Color-Coordinated painted rails - no extra charge
  - Headrail, bottomrail, and middle rail, end caps, cord loops, and handles will color-coordinate to the bottom (honeycomb) fabric
- Fabric wrapped rails - surcharge applies
  - fabric wrapped headrail, bottomrail, and middle rail, end caps, cord loops, and handles will coordinate to the bottom (honeycomb) fabric
- Headrail can be fabric wrapped to match the top (sheer) fabric - surcharge applies
  - Bottomrail, end caps, cord loops, and handles will color-coordinate to the bottom (honeycomb) fabric



NOTES:

- Shades over 42" will have two handles in the middle rail and two handles in the bottomrail. Single handle available, must be selected during order entry.

Cut-outs are not available on TriLight Shades.

CORDLESS LIFT SIZE STANDARDS		
	Honeycomb	2" Hybrid Pleat
	All Fabrics*	All Fabrics
Min. Width (net)	16"	16"
Max. Width**	83" - 96"	83" - 96"
Max. Width – End Mount	48"	42"
Min. Height	12"	12"
Max. Height	84"	84"
Max Area (sq. ft.)	70	60

\* 3/8" single, sheer/semi-sheer and triple cell fabrics are not available with TriLight.

\*\*The bottom panel max. width can be reduced by the ordered sheer fabric (top panel), if the sheer max. width is less than the bottom panel max. width. Willa Sheer maximum width is 83".

See sheer pleated maximum width limitations.

## FINISHED DIMENSIONS

Adjustments are taken from ordered dimensions.  
Measurements may vary +/- 1/8".

	Honeycomb	2" Hybrid Pleat
<b>Inside (IB) Mounts</b>		
Headrail unit	- 1/4"	- 1/4"
Shade height	ordered height	ordered height
Fabric width	- 3/8"	- 3/8"
<b>End (EB) Mounts</b>		
Headrail unit	- 1/2"	- 1/2"
Shade height	ordered height	ordered height
Fabric width	- 5/8"	- 5/8"
<b>Outside (OB) Mount</b>		
Headrail unit	ordered width	ordered width
Shade height	ordered height	ordered height
Fabric width	- 1/8"	- 1/8"

## MOUNTING REQUIREMENTS

Use a metal tape measure for all measurements.

	Honeycomb	2" Hybrid Pleat
<b>Inside (IB) &amp; End (EB) Mounts</b>		
Minimum mounting depth	3/4"	3/4"
Minimum mounting depth, flush mount:	2-1/8"	2-1/8"
<b>Outside (OB) Mount</b>		
Minimum flat vertical surface	1-1/2"	1-1/2"

NOTE: Inside mount with hold down brackets deductions:

- Headrail -1/2"
- Fabric -5/8"
- Bottomrail -1/2"

## FABRIC AND HARDWARE STACKING

- **HONEYCOMB CORDLESS TRILIGHT:** Take 2-1/2" for rails, plus 1/8" for each 12" of honeycomb shade height, plus 1/8" for each 12" of pleated shade height.
- **2" HYBRID PLEAT CORDLESS TRILIGHT:** Take 2-1/2" for rails, plus 1/4" for each 12" of shade height, plus 1/8" for each 12" of pleated shade height. Allow 1-1/2" for fabric fold over.

# TRILIGHT CONFIGURATION SPECIFICATIONS



## TRILIGHT – CORDLESS LIFT & LOCK

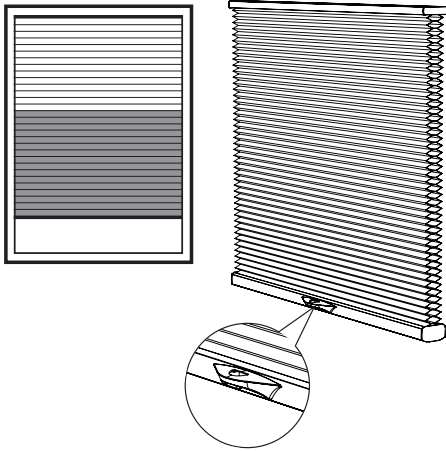

CORDLESS LIFT & LOCK SIZE STANDARDS				
	Honeycomb			2" Hybrid Pleat
	All 3/4" Semi-Opaque Fabrics	All 3/4" Blackout Fabrics	All 1/2" Double Cell Fabrics	All Fabrics
Min. Width (net)	12"	12"	12"	12"
Max. Width	84"	84"	84"	84"
Max. Width - End Mount	48"	48"	48"	42"
Min. Height	12"	12"	12"	12"
Max. Height	84"	84"	84"	84"
Max. Area (sq. ft.)	49	49	49	49

\* 3/8" single, 3/4" sheer/semi-sheer and triple cell fabrics are not available with TriLight.  
 \*\* Willa Sheer max. width is 83".

### Options:

- Color-Coordinated painted rails - no extra charge  
 – Headrail, bottomrail, and middle rail, end caps, cord loops, and handles will color-coordinate to the bottom (honeycomb) fabric
- Fabric wrapped rails - surcharge applies  
 – fabric wrapped headrail, bottomrail, and middle rail, end caps, cord loops, and handles will coordinate to the bottom (honeycomb) fabric

Must be specified when order is placed.

### FINISHED DIMENSIONS

Adjustments are taken from ordered dimensions.  
 Measurements may vary +/- 1/8".

	Honeycomb	2" Hybrid Pleat
<b>Inside (IB) Mounts</b>		
Headrail unit	-1/4"	-1/4"
Shade height	Ordered Height	Ordered Height
Fabric width	-3/8"	-3/8"
<b>End (EB) Mounts</b>		
Headrail unit	-1/2"	-1/2"
Shade height	Ordered Height	Ordered Height
Fabric width	-5/8"	-5/8"
<b>Outside (OB) Mount</b>		
Headrail unit	Ordered Width	Ordered Width
Shade height	Ordered Height	Ordered Height
Fabric width	-1/8"	-1/8"

### MOUNTING REQUIREMENTS

Use a metal tape measure for all measurements.

	Honeycomb	2" Hybrid Pleat
<b>Inside (IB) &amp; End (EB) Mounts</b>		
Minimum mounting depth	1-1/4"	1-1/4"
Minimum mounting depth, flush mount:	2-1/4"	2-1/4"
<b>End (OB) Mount</b>		
Minimum flat vertical surface	2"	2"
<b>Outside (OB) Mount</b>		
Minimum flat vertical surface	1"	1"

**Note: Inside mount with hold down brackets deductions:  
 Headrail - 1/2", Fabric - 5/8", Bottomrail - 1/2"**

### FABRIC AND HARDWARE STACKING

- **HONEYCOMB CORDLESS LIFT & LOCK TRILIGHT:** Take 2-1/4" for bottomrail and intermediate rail, plus 5/8" for headrail, plus 1/8" for each 12" of honeycomb shade height, plus 1/8" for each 12" of pleated shade height.
- **2" HYBRID PLEAT CORDLESS LIFT & LOCK TRILIGHT:** Take 2-1/4" for bottomrail and intermediate rail, plus 5/8" for headrail, plus 1/4" for each 12" of shade height, plus 1/8" for each 12" of pleated shade height. Allow 1-1/2" for fabric fold over.

# MOTORIZATION CONFIGURATION SPECIFICATIONS

NOTE: Use metal tape measure for all measurements. Measures to 1/8 inch.

## REMOTELIFT™ 2.0 BATTERY-OPERATED MOTORIZATION

- Fits rectangular window openings
- Remote control battery-operated operation
- Two stacking options: 1) standard bottom-up 2) top-down
- Features the same headrail and bottomrail as Cordless Lift, Continuous Cord Loop, and Simplicity. Fabric wrapped rails are available **for a surcharge**. Color-coordinated rails are available **at no additional charge**. Must be specified when ordering.

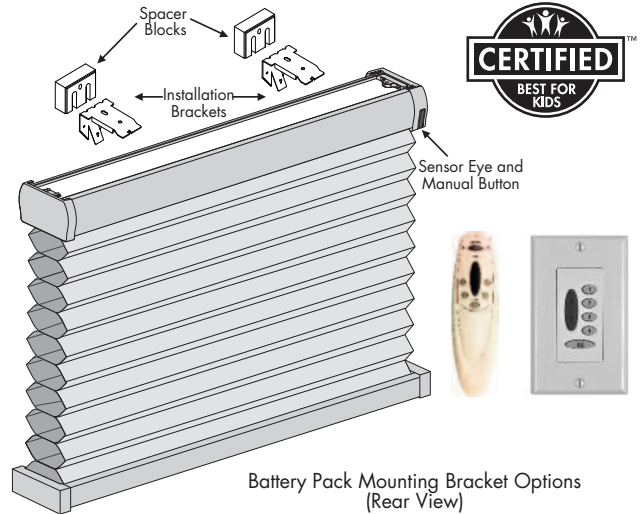

REMOTELIFT 2.0 – SIZE STANDARDS		
	All Honeycomb Fabrics *	2" Hybrid Pleat
Minimum Width	18"	18"
Maximum Width	Refer to chart on page 40	
Max. Width, End Mount	36"	48"
Minimum Height	12"	12"
Maximum Height	Refer to chart on page 40	

\* RemoteLift not available with 3/8" triple cell fabrics

\*\* Max square footage for 2" Hybrid Pleat is 60 sq. feet

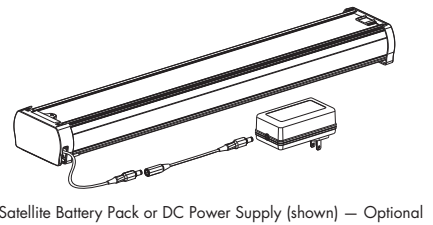
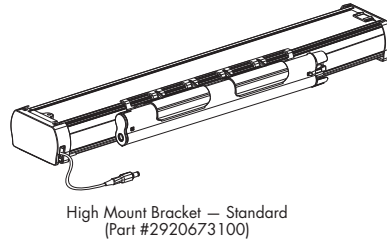
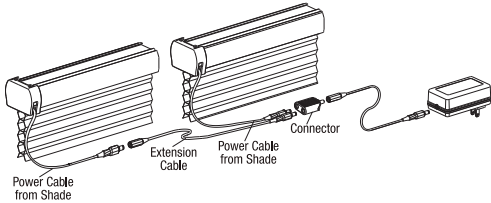

### FINISHED DIMENSIONS

Adjustments are taken from ordered dimensions.

	Honeycomb	2" Hybrid Pleat
<b>Inside (IB) Mounts</b>		
Headrail unit	- 1/4"	- 1/4"
Shade height	ordered height	ordered height
Fabric width	- 3/8"	- 3/8"
<b>End (EB) Mounts</b>		
Headrail unit	- 1/2"	- 1/2"
Shade height	ordered height	ordered height
Fabric width	- 5/8"	- 5/8"
<b>Outside (OB) Mount</b>		
Headrail unit	ordered width	ordered width
Shade height	ordered height	ordered height
Fabric width	- 1/8"	- 1/8"

NOTE: Measurements may vary ± 1/8"

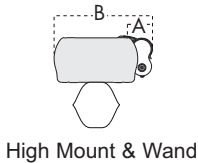

High Mount & Wand

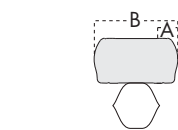

Satellite Pack or DC Power

### MOUNTING REQUIREMENTS

Use a metal tape measure for all measurements.

	Honeycomb	2" Hybrid Pleat
<b>Inside (IB) &amp; End (EB) Mounts</b>		
Minimum mounting depth	1-1/2"	1-1/2"
Minimum mounting depth, flush mount:	2-7/8"	2-7/8"
<b>Outside (OB) Mount</b>		
Minimum flat vertical surface	1-1/2"	1-1/2"

With (Optional) Satellite Battery Pack or DC Power Supply

<b>Inside (IB) &amp; End (EB) Mounts</b>		
Minimum mounting depth	3/4"	3/4"
Minimum mounting depth, flush mount:	2-1/8"	2-1/8"
<b>Outside (OB) Mount</b>		
Minimum flat vertical surface	1-1/2"	1-1/2"

Inside mount with Hold-Down Bracket deductions: Headrail -1/2"  
Fabric -5/8"  
Bottomrail -1/2"

### REMOTELIFT 2.0 ORDERING NOTES

- Hardware colors will complement the fabric. Refer to the Hardware Color Guide for colors and more information.
- Specify left-side or right-side placement for sensor eye.
- Remote controls are ordered separately. Specify the number of remotes you desire.
- To operate multiple shades independently in Radio Frequency, additional remotes will need to be ordered if you have more than 4 shades.
- If ordering a satellite battery pack, specify wire length – 15", 4', 10' or 20'.
- If ordering the DC power supply, specify wire length – 15", 4', 10' or 20'.
- Daisy-Chain requires the DC power supply and you must specify which wire length (15", 4', 10' or 20') at the time the order is placed. You can Daisy-Chain up to 3 blinds per DC power supply.
- Specify "Channel 2" operation for independent operation of adjacent shades.

# MOTORIZATION CONFIGURATION SPECIFICATIONS

## REMOTELIFT™ 2.0 SYSTEM OPTIONS

### BATTERY WAND

Battery wands are the standard power source whether inside (IB), outside (OB) or end (EB) mount, if applicable. Battery wands are mounted on the rear of the headrail. The redesigned battery wand will allow for batteries to be changed without removing the window covering from the window.

- 12 AA 1.5V alkaline batteries.
- Battery life is approximately one year, depending on usage.
- Replace batteries when the window covering(s) begin to operate slowly.



18V Battery Wand  
(Part #7520062000)

### SATELLITE BATTERY PACK

The satellite battery pack is an optional power source. The battery pack connects to the same side of the headrail where the receiver eye or satellite eye is located. The satellite battery pack is the best choice when the window covering is mounted in a high window, restricting access to a battery wand.

- 18V satellite battery pack:
  - Available in 15", 4', 10' and 20' wire lengths.
  - 12 AA 1.5V alkaline batteries.
- Battery life is approximately one year, depending on usage.
- Replace batteries when the window covering(s) begin to operate slowly.
- Mounting options: top of headrail, next to molding or under the sill.
- Satellite battery pack cover can be painted.



18V Satellite Battery Pack  
(Part #KIT2791)

Wire Part #'s:  
15" (Part #2989899000)  
4ft (Part #2989900000)  
10ft (Part #2989901000)  
20ft (Part #2989902000)

### DC POWER SUPPLY

The DC power supply is an optional power source. The DC power supply plugs into any standard household outlet.

- 18V DC power supply:
  - Available in 15", 4', 10' and 20' wire lengths.
- Eliminates need to change batteries.



18V DC Power Supply  
(Part #7806000000)

### DAISY CHAIN

The optional Daisy Chain Adapter allows up to 3 shades to run off of one DC power supply. You must specify the cable wire length when order is placed.

Note: Keep in mind which side the sensor eye is positioned on each side when determining daisy-chain length.



Daisy-Chain Adapter/Connector  
(Part #2989875000)

# SIZE STANDARDS – REMOTELIFT™ 2.0 MOTORIZATION

REMOTELIFT 2.0 MAXIMUM HEIGHTS – STANDARD AND TOP-DOWN																			
CODE	SHADE WIDTH TO:	24"	30"	36"	42"	48"	54"	60"	66"	72"	78"	84"	90"	96"	108"	120"	132"	144"	
	<b>Max Square Footage:</b>	90 Square Feet														70 Square Feet			
H44	3/8" MARCELLA	108"	108"	108"	108"	108"	108"	108"	108"	108"	108"	108"	108"	108"	108"	108"	76"	70"	
	<b>Max Square Footage:</b>	80 Square Feet														70 Square Feet		50 Square Feet	
H40	3/8" OPULENCE	108"	108"	108"	108"	108"	108"	108"	108"	108"	108"	108"	108"	108"	108"	92"	84"	54"	50"
	<b>Max Square Footage:</b>	50 Square Feet														30 Square Feet			
H41	3/8" OPULENCE BLACKOUT	108"	108"	108"	108"	108"	108"	108"	108"	100"	90"	84"	80"	74"	40"	36"	n/a		
	<b>Max Square Footage:</b>	50 Square Feet														30 Square Feet			
H91	3/4" CARDIFF SEMI-OPAQUE	108"	108"	108"	108"	108"	108"	108"	108"	100"	90"	84"	80"	74"	40"	36"	n/a		
	<b>Max Square Footage:</b>	80 Square Feet														65 Square Feet		40 Square Feet	
HS3	3/4" GLIMMER SEMI OPAQUE	108"	108"	108"	108"	108"	108"	108"	108"	108"	108"	108"	108"	108"	108"	86"	78"	42"	40"
	<b>Max Square Footage:</b>	80 Square Feet														60 Square Feet		40 Square Feet	
H27	3/4" LINEN	108"	108"	108"	108"	108"	108"	108"	108"	108"	108"	108"	108"	108"	80"	72"	42"	40"	
	<b>Max Square Footage:</b>	80 Square Feet														75 Square Feet		45 Square Feet	
H45	3/4" MARCELLA	108"	108"	108"	108"	108"	108"	108"	108"	108"	108"	108"	108"	108"	100"	90"	48"	44"	
	<b>Max Square Footage:</b>	80 Square Feet														75 Square Feet		45 Square Feet	
HX6	3/4" Melodic Semi-Opauqe	108"	108"	108"	108"	108"	108"	108"	108"	108"	108"	108"	108"	108"	100"	90"	48"	44"	
	<b>Max Square Footage:</b>	80 Square Feet														75 Square Feet		45 Square Feet	
H92	3/4" Mirada Semi-Opauqe	108"	108"	108"	108"	108"	108"	108"	108"	108"	108"	108"	108"	108"	100"	90"	48"	44"	
	<b>Max Square Footage:</b>	80 Square Feet														60 Square Feet		40 Square Feet	
H28	3/4" OPULENCE	108"	108"	108"	108"	108"	108"	108"	108"	108"	108"	108"	108"	108"	80"	72"	42"	40"	
	<b>Max Square Footage:</b>	80 Square Feet														60 Square Feet		40 Square Feet	
H96	3/4" PEACEFUL SEMI-OPAQUE	108"	108"	108"	108"	108"	108"	108"	108"	108"	108"	108"	108"	108"	80"	72"	42"	40"	
	<b>Max Square Footage:</b>	80 Square Feet														60 Square Feet		40 Square Feet	
HF6	3/4" RADIANCE SEMI-OPAQUE	108"	108"	108"	108"	108"	108"	108"	108"	108"	108"	108"	108"	108"	80"	72"	42"	40"	
	<b>Max Square Footage:</b>	30 Square Feet																	
H62	3/4" SERENE FR	108"	108"	108"	102"	90"	80"	72"	64"	60"	54"	50"	48"	44"	n/a				
	<b>Max Square Footage:</b>	35 Square Feet																	
H46	3/4" MARCELLA BLACKOUT	108"	108"	108"	108"	104"	92"	84"	76"	70"	64"	60"	56"	52"	n/a				
	<b>Max Square Footage:</b>	35 Square Feet																	
H29	3/4" OPULENCE BLACKOUT	108"	108"	108"	108"	104"	92"	84"	76"	70"	64"	60"	56"	52"	n/a				
	<b>Max Square Footage:</b>	35 Square Feet																	
HF7	3/4" RADIANCE BLACKOUT	108"	108"	108"	108"	104"	92"	84"	76"	70"	64"	60"	56"	52"	n/a				
	<b>Max Square Footage:</b>	30 Square Feet																	
H60	3/4" SERENE FR BLACKOUT	108"	108"	108"	102"	90"	80"	72"	64"	60"	54"	50"	48"	44"	n/a				
	<b>Max Square Footage:</b>	90 Square Feet														55 Square Feet			
H25	3/4" TIFFANY SHEER	108"	108"	108"	108"	108"	108"	108"	108"	108"	108"	108"	108"	108"	108"	108"	60"	54"	
	<b>Max Square Footage:</b>	50 Square Feet														35 Square Feet			
H24	3/4" TRANQUILITY SEMI-SHEER	108"	108"	108"	108"	108"	108"	108"	108"	100"	90"	84"	80"	74"	46"	42"	n/a		
	<b>Max Square Footage:</b>	45 Square Feet														30 Square Feet			
H47	1/2" MARCELLA DOUBLE CELL	108"	108"	108"	108"	108"	108"	108"	98"	90"	82"	76"	72"	68"	40"	36"	n/a		
	<b>Max Square Footage:</b>	40 Square Feet														25 Square Feet			
H39	1/2" OPULENCE DOUBLE CELL	108"	108"	108"	108"	108"	106"	96"	86"	80"	72"	68"	64"	60"	32"	30"	n/a		
	<b>Max Square Footage:</b>	35 Square Feet																	
HPF	2" HYBRID PLEAT - SEMI-OPAQUE	108"	108"	108"	108"	104"	92"	84"	76"	70"	64"	60"	56"	52"	n/a				
	<b>Max Square Footage:</b>	30 Square Feet																	
HPR	2" HYBRID PLEAT - BLACKOUT	108"	108"	108"	102"	90"	80"	72"	64"	60"	54"	50"	48"	44"	n/a				

**NOTE: TRIPLE CELL FABRICS NOT AVAILABLE WITH REMOTELIFT 2.0.**  
**NOTE: SPECIFICATIONS HAVE BEEN UPDATED. PLEASE REVIEW WHEN ORDERING.**



## REMOTELIFT 2.0

**RemoteLift 2.0** uses a combination of two different types of wireless signals to control window coverings: radio waves and an infrared signal.

By combining these two signal methods, RemoteLift 2.0 gives consumers the best features and control in the industry. Whether opening a single window covering or partially closing a roomful of coverings at the same time, RemoteLift 2.0 provides the ultimate in control.

### **WHAT IS RADIO FREQUENCY?**

Radio frequency (RF) in today's world simply refers to the use of radio waves of a given frequency to wirelessly send data from a transmitter to a receiver. RemoteLift 2.0 uses radio waves in the 2.4GHz (pronounced "gigahertz") frequency range to send commands from the remote or to the receiver at the window covering.

Radio waves, due to their nature, pass through solid objects and radiate in every direction. That means a remote sending an RF signal does not need to be pointed at a window covering in order to control it. The remote does not have to be in the same room as the window covering it operates nor does the satellite eye need to be visible.

People use products that send radio frequency signals every day. From cell phones and keyless car FOBs, to baby monitors and even garage door openers. Each device sends out RF signals (radio waves) to a receiver on the other end. If the receiver on the other end doesn't "hear" the signal being sent, nothing happens (or a cell phone call gets dropped).

### *Operational Distance of Radio Waves*

Range of operation may vary due to common household construction, layout and other wireless devices in the home. Much like reception with a cell phone, there may be better locations within a home to use radio frequency than others.

### **WHAT IS INFRARED?**

An infrared (IR) signal uses an invisible beam of energy to send commands from a limited distance (usually less than 30 feet) to an electronic device. Similar to a flashlight, a clear line of sight between the device sending the signal and the device receiving the signal is necessary. Likewise, an infrared beam reflects off solid surfaces, bouncing around a room, which could activate a window covering unintentionally.

Products that use an infrared signal as a means of communication are so common, people seldom think about it. The most common device that uses an infrared signal sent from a remote in today's world is the television. By pointing the TV remote at the television and pressing a button, the television responds by changing channels, changing the volume level or powering off.

### *Operational Distance of Infrared Signals*

The maximum operational distance an infrared signal can travel is 30 feet or less in a straight line. There cannot be any physical obstructions (like a drapery, top-treatment or cornice) between the remote and the receiver eye.

Also, an infrared signal can be compromised by direct sunlight or bright interior light. Keep all infrared receivers out of direct sunlight for better operation.

# REMOTELIFT™ 2.0 MOTORIZATION: OVERVIEW

## REMOTELIFT 2.0

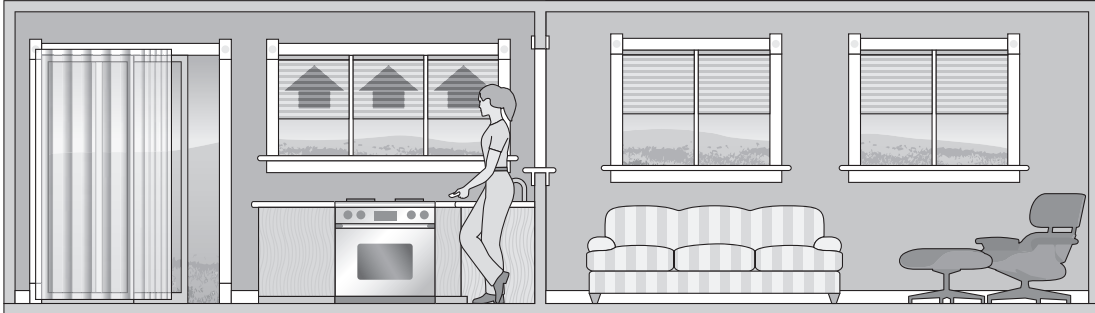

Operation of a group of window coverings using radio frequency.

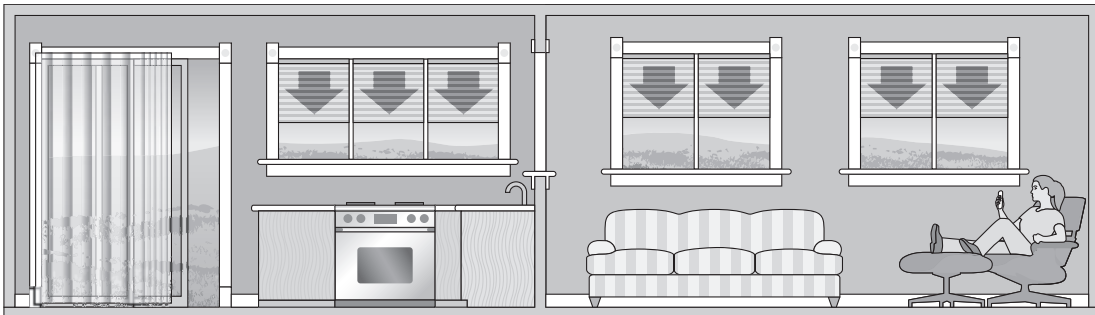

Operation of multiple groups of window coverings using radio frequency.

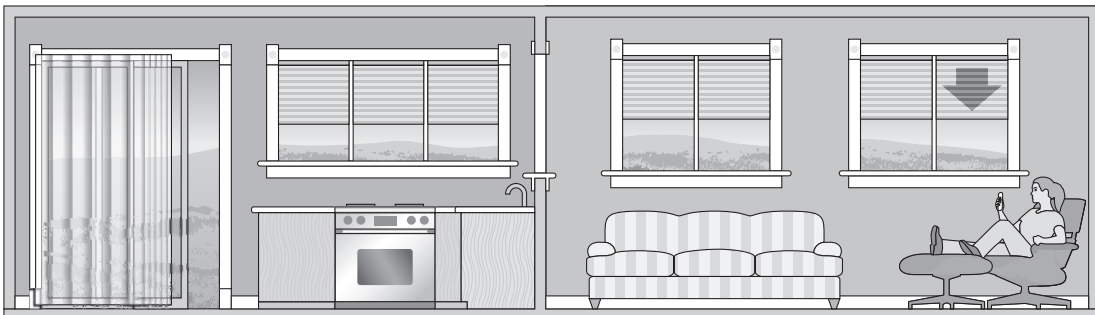

Operation of a single window covering using infrared or radio frequency.

# SIMPLICITY MOTORIZATION SPECIFICATIONS POWERWAND™ MOTORIZATION SPECIFICATIONS

## SIMPLICITY AND POWERWAND MOTORIZATION

- Features the same headrail and bottomrail as Cordless Lift, Continuous Cord Loop, and RemoteLift 2.0. Fabric wrapped rails are available **for a surcharge**. Color-coordinated rails are available at **no additional charge**. Must be specified when ordering.



SIMPLICITY & POWERWAND - SIZE STANDARDS		
	All Honeycomb Fabrics *	2" Hybrid Pleat **
Minimum Width - Bottom-Up	18"	18"
Minimum Width - Top-Down/Bottom-Up	24"	24"
Maximum Width	96"	96"
Maximum Width, End Mount ***	36"	36"
Minimum Height	12"	12"
Maximum Height	96"	96"

\* Simplicity not available with 3/8" triple cell fabrics

\*\* PowerWand **not available** with 3/8" triple cell or 2" Hybrid Pleat fabrics

\*\*\* Rechargeable Simplicity Top-Down/Bottom-Up **not available** as End Mount

NOTE: Size Standards are the same for standard Simplicity, Rechargeable Simplicity **Bottom-Up**, and PowerWand

NOTE: Min Width for **Rechargeable Simplicity Top-Down/Bottom-Up** is 24"

NOTE: Max height varies by width and fabric type. Refer to chart on page 48

SIMPLICITY 2-on-1 HEADRAIL - SIZE STANDARDS		
	All Honeycomb Fabrics *	2" Hybrid Pleat **
Minimum Width (per panel)	20"	20"
Minimum Width (overall)	40"	40"
Maximum Width (per panel)	96"	96"
Maximum Width (overall)	144"	144"
Minimum Height	12"	12"
Maximum Height	96"	96"

\* Simplicity not available with 3/8" triple cell fabrics

NOTE: Simplicity 2-on-1 **ONLY** available with **Rechargeable** battery.

**Not available** with standard Simplicity, PowerWand or Top-Down/Bottom-Up.

### FINISHED DIMENSIONS

#### Standard, Rechargeable Bottom-Up and Top-Down/Bottom-Up, and PowerWand

Adjustments are taken from ordered dimensions.

	Honeycomb	Hybrid Pleat
<b>Inside (IB) Mounts</b>		
Headrail unit	- 1/4"	- 1/4"
Shade height	ordered height	ordered height
Fabric width	- 3/8"	- 3/8"
<b>Outside (OB) Mount</b>		
Headrail unit	ordered width	ordered width
Shade height	ordered height	ordered height
Fabric width	- 1/8"	- 1/8"
<b>End (EB) Mount*</b>		
Headrail unit	- 1/2"	ordered width
Shade height	ordered height	ordered height
Fabric width	- 5/8"	- 1/8"

\* End Mount is **not available** with Top-Down/Bottom-Up

#### Simplicity Rechargeable ONLY

2-on-1 Headrail		
Gap between panels	-1/4"	-1/4"

NOTE: 2-on-1 Headrail is **not available** with Top-Down/Bottom-Up

NOTE: Measurements may vary ± 1/8"

NOTE: PowerWand is **not available** with Hybrid Pleat fabrics

### MOUNTING REQUIREMENTS

#### Standard, Rechargeable Bottom-Up, and PowerWand

Use a metal tape measure for all measurements.

Honeycomb & Hybrid Pleat	
<b>Inside (IB) Mount</b>	
Minimum mounting depth	3/4"
Minimum mounting depth, flush mount:	2-1/8"
<b>Outside (OB) Mount</b>	
Minimum flat vertical surface	1-1/2"

#### Rechargeable Top-Down/Bottom-Up

##### Mounting Requirements

Use a metal tape measure for all measurements.

Honeycomb & Hybrid Pleat	
<b>Inside (IB) Mount</b>	
Minimum mounting depth	3/4"
Minimum mounting depth, flush mount	
<b>Over 36" wide</b>	2-1/4"
<b>Under 36" wide (spacer blocks required)</b>	3"

<b>Outside (OB) Mount</b>	
Minimum flat vertical surface	1-1/2"

---

## STANDARD SIMPLICITY MOTORIZATION: OVERVIEW

---

### Standard Simplicity Motorization

- Standard Simplicity Motorization features either a battery powered motor utilizing a single battery wand or plug-in DC transformer. Simplicity motors are compact and use a radio controlled remote to raise or lower the shades.
- Either batteries or 12 Volt DC power supply/transformer is available. The battery wand can be clipped to the headrail or wall or ceiling mounted utilizing battery wand clips. The 12 volt battery wand measures 17", and comes with eight AA alkaline batteries, and is white in color. The battery wire is 10" long. The DC power supply is white and comes with a 80" wire, must be plugged into a standard outlet to power the motor and can power a single shade.
- A 48" extension wire is available (Part #CS5133Z).



## SIMPLICITY RECHARGEABLE MOTORIZATION: OVERVIEW

### Simplicity Rechargeable

- The Rechargeable Simplicity motor program features an integrated rechargeable lithium ion battery in the motor casing and is fully concealed by the inner tube.
- Rechargeable battery is included with the motor. The average battery charge will last 6-12 months based on an average sized shade raised and lowered once per day. The life of the battery charge will vary based on the type of window covering selected, the size and weight of the window covering and the number of times the shade is operated on a daily basis. The battery can be recharged up to 500 times. It takes approximately 5 hours to recharge the motor when fully depleted.

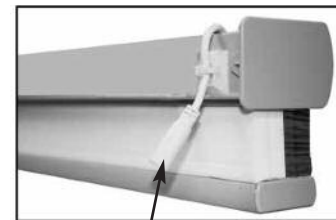

Charging Port

### Battery Charger

- An 8.4 Volt charger requires a standard power outlet to recharge the battery. The charger must be specified when ordering Simplicity Rechargeable Motorized shade option. The charger plugs into the charging port of the motor. The charger is black and comes with a 156" wire. The dimensions are 1" wide x 2-1/2" length x 1-3/4" deep. Sold separately.



(Part #CS5199)

### Solar Panel Recharge Option

- Plugs in to any Simplicity Rechargeable motorized shading (does not work with PowerWand™). Provides constant trickle charge to 7.4v Li-ION Rechargeable battery packs. Does not require direct sunlight, but performs best in regular direct sunlight applications. Will prolong the life of the charge of the 7.4v rechargeable battery packs, and in some applications will maintain charge indefinitely.
- Life of charge is subject to application variables such as, size and weight of shade, frequency of use, amount of direct sunlight exposure, etc.

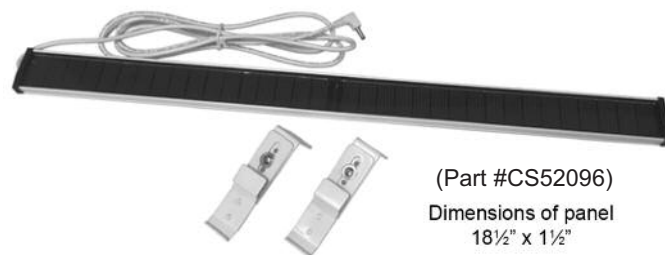

(Part #CS52096)  
Dimensions of panel  
18½" x 1½"

### 5 Channel Remote

- The remote can operate up to five shadings simultaneously, individually or in groups. Remotes and holders are available in white or black. The remote comes with a holder which can be mounted to a wall for easy storage. The range of the remote is approximately 80 feet.



### Please Note:

- Not all motors run at the same rate of speed.
- Simplicity motors have a "Favorites" position setting. To set a "Favorites" position, follow instructions provided in the installation instructions.

# SIMPLICITY RECHARGEABLE TOP-DOWN/BOTTOM-UP: OVERVIEW

## Rechargeable Simplicity Motors

- The Simplicity TDBU Motor program features a battery powered motor utilizing a rechargeable battery hidden inside the shade head rail. If shades are less than 36" in width, an external snap-on battery pack is necessary.

## Top-Down/Bottom-Up Simplicity 14 Channel Remote

- The TDBU remote has 14-channels and an ALL option. Each channel has a setting able to operate the middle rail and a setting able to operate the bottom rail. The TDBU remote is required for TDBU motors, but can be used with other motors as well. The 14 Channel TDBU remote can operate up to fourteen shades individually or 14 groups (not recommended). Simplicity Rechargeable Motorized Cellular Shades are programmed at the factory with the "up and down" limits. Please ensure each shade is linked to the remote prior to installation.



(Part #CS52136)

- Simplicity TDBU remotes and holders are white in color. The remote comes with a holder which can be mounted to a wall for easy storage. The range of the remote is approximately 80 feet. The 14 Channel remote can be utilized on all Simplicity motorized shades.

## Simplicity Rechargeable Battery for Top-Down/Bottom-Up

- For shades 36" and wider the rechargeable battery is fully concealed in the head rail and is recharged via a charging port on the back of the shade. Shades under 36" in width require an externally mounted battery pack. Both the internal and external rechargeable batteries come fully charged from the factory.



Internal Battery charging port



External Battery Pack

## Battery Charger

- Utilizes the same 8.4 Volt charger as Simplicity Rechargeable Bottom-Up and PowerWand



(Part #CS5199)

## Solar Panel Recharge Option

- Uses the same Solar Panel recharge option as Simplicity Rechargeable Bottom-up.



(Part #CS52096)

Dimensions of panel  
18½" x 1½"

# POWERWAND™ MOTORIZATION: OVERVIEW

## PowerWand™ Motorization

- Honeycomb Shades can be fabricated with the PowerWand™ Rechargeable Push Button Control option. The PowerWand™ Rechargeable option is an easy, cord free motorized operation for the budget savvy homeowner. PowerWand™ Rechargeable uses Simplicity motors and components.

## PowerWand™ Rechargeable Shades Operation

- Press the up or down button on the pendant to raise or lower the shading to your desired position. No programming is required with PowerWand™ as upper and lower limits are set at the factory. If desired, upper and lower limits can be adjusted in the field.
- Please refer to the installation instructions for instructions on resetting the upper and lower limits and setting a favorites position can be programmed on-site.

## PowerWand™ Appearance

- The PowerWand™ Rechargeable wand and pendant is attached to the head rail and requires no additional mounting.
- The wand and pendant hangs down the front of the shades from the head rail.
- Pendant is 2-1/2" long.
- The pendant does not need to be mounted to the wall to operate the shade.

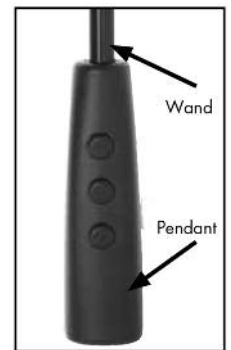

## PowerWand™ Options

- Wand is available in Black or White (there is no default)
- Wand is available in 1 foot increments from 1 to 5 feet (there is no default)
- Wand is available on either the right or left side of the shade (there is no default)



White



Black Shown with Plug-In Charger

## PowerWand™ Battery Life

- The battery life will vary based on the type of window covering selected, the size and weight of the window covering and the number of times you operate the blind on a daily basis.

## Battery Charger

- 8.4 Volt charger requires a standard power outlet to recharge the battery. The charger must be specified when ordering the PowerWand™ motorization option. The charger plugs into the charger port on the side of the pendant. The charger is black and comes with a 156" wire. The dimensions are 1" wide x 2-1/2" length x 1-3/4" deep.



(Part #CS5199)



## SIZE STANDARDS – SIMPLICITY MOTORIZATION

<b>SIMPLICITY MOTORIZATION (Bottom-Up and Top-Down/Bottom-Up*) &amp; POWERWAND - MAXIMUM HEIGHTS</b>				
CODE	SHADE WIDTH TO:	18" – 72" **	84"	96"
H44	3/8" Marcella Semi-Opaque	96"	96"	96"
H40	3/8" Opulence Semi-Opaque	96"	96"	96"
H41	3/8" Opulence Blackout	96"	96"	96"
H91	3/4" Cardiff Semi-Opaque	96"	90"	72"
HS3	3/4" Glimmer Semi Opaque	96"	96"	96"
H27	3/4" Linen Semi-Opaque	96"	96"	96"
H45	3/4" Marcella Semi-Opaque	96"	96"	96"
HX6	3/4" Melodic Semi-Opaque	96"	90"	72"
H92	3/4" Mirada Semi-Opaque	96"	90"	72"
H28	3/4" Opulence Semi-Opaque	96"	90"	72"
H96	3/4" Peaceful Semi-Opaque	96"	90"	72"
HF6	3/4" Radiance Semi-Opaque	96"	90"	72"
H60	3/4" Serene FR Semi-Opaque	96"	90"	72"
H46	3/4" Marcella Blackout	96"	90"	72"
H29	3/4" Opulence Blackout	96"	90"	72"
HF7	3/4" Radiance Blackout	96"	90"	72"
H62	3/4" Serene FR Blackout	96"	90"	72"
H25	3/4" Tiffany Sheer	96"	96"	96"
H24	3/4" Tranquility Semi-Sheer	96"	90"	72"
H39	Opulence 1/2" Double Cell	96"	90"	72"
H47	1/2" Marcella Double Cell	96"	96"	96"
HPF	2" Hybrid Pleat Semi-Opaque***	96"	96"	96"
HPR	2" Hybrid Pleat - Blackout***	96"	90"	72"

\* 2-on-1 Minimum Panel Width 20" (available with **Bottom-Up Simplicity Rechargeable ONLY**)

\* Top-Down/Bottom-Up Minimum Panel Width 24" (available with **Simplicity Rechargeable ONLY**)

\*\*\* 2" Hybrid Pleat is Not Available with PowerWand Motorization

**NOTE: Triple Cell fabric is not Available with motorization**

### HONEYCOMB VERTICAL APPLICATION A

• 3/4" Marcella (H45) • 3/4" Radiance (HF6)

WIDTH TO:	24"	30"	36"	42"	48"	54"	60"	66"	72"	78"	84"	96"	108"	120"	132"	144"	156"	168"
HEIGHT TO:																		
36"	\$600	648	706	758	809	860	913	963	1016	1069	1113	1210	1302	1391	1469	1557	1646	1741
42"	639	699	761	821	876	936	1000	1055	1110	1170	1223	1318	1409	1515	1600	1706	1805	1925
48"	682	745	816	881	942	1007	1071	1147	1198	1256	1322	1424	1520	1658	1734	1847	1934	2063
54"	715	797	869	945	1009	1069	1138	1203	1267	1325	1391	1499	1617	1739	1851	1960	2084	2210
60"	758	841	924	1005	1069	1138	1209	1278	1347	1416	1478	1608	1736	1867	1978	2111	2242	2387
66"	802	888	973	1067	1143	1209	1283	1363	1428	1509	1575	1718	1854	1994	2118	2268	2406	2581
72"	846	938	1034	1131	1205	1276	1348	1447	1516	1594	1674	1830	1968	2121	2259	2420	2576	2756
78"	890	986	1092	1180	1262	1331	1416	1515	1584	1676	1752	1920	2067	2228	2378	2541	2712	2901
84"	936	1037	1145	1239	1329	1409	1497	1596	1672	1769	1851	2028	2194	2357	2511	2696	2868	3078
90"	972	1088	1195	1294	1389	1478	1570	1677	1764	1861	1952	2141	2314	2491	2659	2843	3036	3246
96"	1016	1134	1239	1343	1440	1534	1631	1748	1837	1943	2029	2233	2406	2603	2785	2965	3170	3379
102"	1058	1179	1294	1396	1497	1605	1716	1824	1930	2029	2123	2339	2534	2725	2914	3117	3337	3568
108"	1101	1226	1345	1456	1564	1669	1792	1916	2017	2130	2228	2450	2654	2859	3061	3269	3503	3747
114"	1145	1272	1394	1516	1624	1738	1867	1992	2107	2220	2321	2569	2779	2992	3211	3414	3673	3908
120"	1180	1322	1497	1619	1734	1853	1989	2123	2240	2362	2454	2710	2932	3158	3377	3597	3853	4099

- 3/4" Cardiff (H91)
- 3/4" Glimmer (HS3)
- 3/4" Linen (H27)
- 3/4" Marcella Blackout (H46)
- 3/4" Melodic (HX6)
- 3/4" Mirada (H92)
- 3/4" Opulence (H28)
- 3/4" Radiance Blackout (HF7)
- 3/4" Serene (H62)

### HONEYCOMB VERTICAL APPLICATION B

WIDTH TO:	24"	30"	36"	42"	48"	54"	60"	66"	72"	78"	84"	96"	108"	120"	132"	144"	156"	168"
HEIGHT TO:																		
36"	\$703	761	832	892	949	1009	1072	1134	1196	1256	1309	1423	1532	1631	1723	1828	1930	2051
42"	751	819	894	965	1030	1097	1168	1239	1304	1377	1435	1548	1658	1778	1879	2006	2121	2263
48"	798	873	959	1037	1104	1184	1260	1347	1407	1478	1552	1676	1785	1945	2036	2171	2274	2424
54"	841	934	1018	1108	1187	1256	1334	1416	1486	1557	1631	1761	1902	2049	2174	2305	2449	2595
60"	890	986	1088	1180	1256	1334	1423	1501	1582	1663	1738	1886	2040	2194	2328	2480	2634	2806
66"	945	1042	1147	1255	1341	1423	1509	1605	1681	1773	1854	2021	2180	2344	2489	2666	2833	3034
72"	996	1101	1212	1329	1417	1497	1585	1702	1780	1874	1968	2151	2312	2491	2657	2843	3029	3245
78"	1046	1157	1279	1386	1483	1564	1663	1778	1865	1971	2058	2254	2429	2620	2792	2988	3188	3411
84"	1097	1216	1345	1458	1561	1658	1757	1876	1966	2079	2174	2385	2580	2774	2953	3169	3376	3621
90"	1145	1276	1401	1520	1630	1736	1847	1975	2074	2189	2293	2518	2721	2930	3124	3342	3570	3818
96"	1195	1331	1456	1577	1692	1807	1922	2052	2160	2286	2389	2624	2834	3062	3269	3491	3728	3973
102"	1242	1386	1520	1640	1759	1883	2015	2144	2270	2390	2495	2749	2979	3204	3429	3666	3920	4193
108"	1294	1440	1580	1711	1837	1962	2111	2251	2374	2503	2620	2882	3119	3361	3598	3848	4118	4405
114"	1343	1493	1637	1780	1911	2044	2194	2343	2477	2613	2728	3015	3266	3517	3779	4019	4318	4594
120"	1386	1552	1757	1902	2036	2178	2337	2493	2633	2779	2886	3186	3448	3712	3972	4228	4527	4823

\*\*IMPORTANT NOTE:\*\*

3/4" Serene FR Semi-opaque (H62) and 3/4" Serene FR Blackout (H60) fabrics do not meet the NFPA 701 flammability requirements when used in a Vertical Application.

OPTIONS: NO EXTRA CHARGE
<ul style="list-style-type: none"> <li>• Vertical Application – Left or Right stack location</li> </ul>

VERTICAL APPLICATION STACK DESIGN SURCHARGES
<ul style="list-style-type: none"> <li>• Center Opening – Price as two separate shades.</li> <li>• Center Stacking .....add \$92 each</li> </ul>

### HONEYCOMB VERTICAL APPLICATION C

- 3/4" Opulence Blackout (H29)
- 3/4" Serene Blackout (H60)

WIDTH TO:	24"	30"	36"	42"	48"	54"	60"	66"	72"	78"	84"	96"	108"	120"	132"	144"	156"	168"	
HEIGHT TO:																			
36"	\$818	903	1000	1085	1154	1207	1281	1354	1424	1497	1562	1695	1868	2014	2157	2312	2459	2564	
42"	888	986	1092	1168	1248	1318	1396	1478	1561	1631	1713	1854	2044	2205	2374	2546	2712	2834	
48"	961	1055	1157	1248	1331	1407	1493	1585	1674	1755	1844	2006	2208	2390	2576	2760	2944	3080	
54"	1025	1134	1242	1345	1432	1527	1623	1723	1819	1918	2010	2187	2412	2613	2815	3029	3225	3384	
60"	1095	1198	1324	1432	1531	1628	1732	1847	1952	2058	2160	2346	2592	2813	3034	3264	3480	3662	
66"	1156	1263	1405	1529	1628	1736	1838	1969	2077	2197	2307	2514	2779	3015	3254	3501	3736	3929	
72"	1223	1332	1479	1619	1727	1838	1960	2091	2205	2339	2456	2682	2969	3223	3476	3747	4004	4216	
78"	1283	1398	1564	1707	1824	1948	2079	2217	2343	2486	2615	2845	3146	3425	3705	3986	4260	4492	
84"	1341	1467	1637	1789	1911	2042	2189	2334	2470	2620	2755	3008	3328	3625	3915	4219	4513	4764	
90"	1401	1534	1718	1877	2005	2150	2307	2454	2603	2764	2903	3174	3512	3825	4136	4463	4773	5042	
96"	1463	1605	1791	1969	2097	2256	2422	2585	2735	2905	3057	3342	3706	4034	4366	4704	5033	5321	
102"	1524	1674	1872	2049	2182	2364	2535	2707	2861	3045	3195	3491	3862	4210	4557	4913	5265	5571	
108"	1584	1741	1946	2132	2263	2473	2647	2831	2983	3172	3331	3648	4041	4407	4775	5150	5514	5838	
114"	1638	1821	2022	2220	2353	2578	2760	2949	3117	3307	3469	3811	4225	4605	4998	5385	5778	6114	
120"	1759	1959	2167	2381	2514	2742	2935	3135	3307	3506	3673	4035	4463	4869	5272	5679	6086	6446	

\*\*IMPORTANT NOTE:\*\*

3/4" Serene FR Semi-opaque (H62) and 3/4" Serene FR Blackout (H60) fabrics do not meet the NFPA 701 flammability requirements when used in a Vertical Application.

### HONEYCOMB VERTICAL APPLICATION D

- 3/4" Peaceful (H96)

WIDTH TO:	24"	30"	36"	42"	48"	54"	60"	66"	72"	78"	84"	96"	108"	120"	132"	144"	156"	168"	
HEIGHT TO:																			
36"	\$924	1019	1131	1226	1304	1364	1446	1531	1610	1692	1764	1916	2111	2274	2436	2613	2779	2896	
42"	1005	1115	1233	1322	1410	1488	1578	1669	1762	1844	1936	2097	2309	2491	2682	2878	3066	3202	
48"	1087	1191	1308	1410	1504	1589	1690	1792	1891	1983	2082	2266	2495	2702	2910	3119	3326	3482	
54"	1157	1281	1405	1520	1617	1727	1835	1948	2054	2166	2270	2470	2725	2953	3181	3422	3644	3823	
60"	1237	1354	1493	1617	1730	1840	1957	2088	2206	2325	2442	2652	2930	3179	3429	3689	3931	4138	
66"	1306	1428	1585	1729	1840	1962	2077	2224	2348	2482	2608	2841	3140	3406	3676	3956	4223	4442	
72"	1380	1506	1672	1830	1950	2077	2213	2364	2491	2641	2776	3032	3354	3643	3927	4235	4524	4764	
78"	1451	1580	1768	1930	2061	2203	2350	2505	2647	2810	2955	3215	3554	3871	4186	4504	4814	5074	
84"	1516	1658	1849	2021	2159	2307	2473	2636	2790	2960	3114	3400	3761	4095	4425	4768	5100	5383	
90"	1584	1734	1941	2121	2265	2429	2608	2772	2940	3123	3280	3586	3968	4322	4674	5044	5392	5696	
96"	1653	1812	2022	2224	2367	2548	2735	2923	3091	3282	3455	3775	4187	4557	4932	5316	5689	6013	
102"	1722	1891	2114	2314	2466	2672	2864	3057	3232	3441	3613	3945	4364	4755	5150	5551	5949	6296	
108"	1791	1968	2201	2410	2558	2795	2990	3199	3370	3584	3765	4124	4564	4978	5394	5820	6231	6595	
114"	1851	2058	2286	2511	2659	2912	3119	3331	3522	3736	3920	4306	4773	5203	5647	6086	6528	6908	
120"	1987	2212	2449	2689	2841	3098	3315	3544	3736	3963	4149	4559	5044	5502	5955	6418	6878	7285	

**OPTIONS: NO EXTRA CHARGE**

- Vertical Application – Left or Right stack location

**VERTICAL APPLICATION STACK DESIGN SURCHARGES**

- Center Opening – Price as two separate shades.
- Center Stacking .....add \$92 each

## 2" HYBRID PLEAT VERTICAL APPLICATION G

• 2" HYBRID PLEAT – SEMI-OPAQUE (HPF)

WIDTH TO:	24"	30"	36"	42"	48"	54"	60"	66"	72"	84"	96"	108"	120"	132"	144"	156"	168"
<b>HEIGHT TO:</b>																	
36"	\$621	742	743	786	814	869	901	1053	1094	1170	1226	1430	1612	1773	1932	2105	2261
42"	701	754	772	809	848	892	933	1088	1131	1217	1272	1465	1658	1822	1989	2166	2330
48"	736	779	791	855	933	943	975	1161	1189	1281	1348	1545	1773	1950	2127	2318	2491
54"	763	825	832	892	968	973	1011	1198	1239	1324	1387	1603	1812	1994	2174	2369	2544
60"	768	850	851	933	1005	1009	1046	1233	1276	1378	1451	1676	1893	2082	2270	2473	2659
66"	825	901	904	956	1005	1030	1067	1276	1309	1407	1499	1725	1950	2146	2339	2549	2741
72"	844	940	940	996	1025	1081	1120	1345	1371	1499	1587	1812	2052	2256	2459	2682	2882
78"	975	1067	1085	1131	1173	1228	1276	1340	1377	1492	1594	1831	2065	2274	2477	2698	2903
84"	1003	1095	1117	1166	1217	1276	1322	1387	1435	1552	1665	1911	2146	2358	2572	2806	3013
90"	1039	1136	1140	1191	1240	1311	1370	1435	1486	1603	1727	1980	2226	2447	2668	2909	3126
96"	1060	1166	1173	1223	1272	1352	1405	1470	1531	1654	1775	2035	2298	2528	2753	3004	3227
108"	1173	1308	1311	1375	1442	1525	1617	1692	1764	1918	2074	2371	2664	2932	3195	3480	3743
120"	1258	1416	1469	1545	1623	1722	1815	1916	2003	2171	2353	2686	3006	3307	3604	3929	4223

## 2" HYBRID PLEAT VERTICAL APPLICATION H

• 2" HYBRID PLEAT – BLACKOUT (HPR)

WIDTH TO:	24"	30"	36"	42"	48"	54"	60"	66"	72"	84"	96"	108"	120"	132"	144"	156"	168"
<b>HEIGHT TO:</b>																	
36"	\$706	752	759	804	832	887	919	1076	1115	1196	1249	1460	1644	1807	1969	2146	2307
42"	720	774	784	825	864	911	947	1118	1156	1240	1295	1497	1695	1865	2033	2215	2381
48"	749	798	809	867	970	979	993	1184	1214	1308	1375	1573	1808	1991	2166	2364	2539
54"	775	846	844	913	998	993	1026	1223	1262	1352	1417	1642	1851	2036	2220	2419	2599
60"	784	864	867	947	1058	1035	1065	1260	1304	1407	1474	1706	1925	2118	2307	2518	2705
66"	837	920	920	972	1064	1057	1092	1308	1336	1440	1525	1759	1987	2185	2381	2594	2788
72"	864	959	961	1011	1081	1099	1138	1371	1398	1527	1614	1847	2090	2298	2503	2730	2935
78"	998	1088	1103	1152	1196	1256	1302	1366	1407	1522	1624	1867	2100	2311	2519	2746	2951
84"	1083	1187	1212	1269	1327	1398	1456	1527	1584	1722	1847	2116	2374	2613	2845	3103	3335
90"	1189	1309	1320	1382	1442	1524	1589	1669	1729	1874	2017	2314	2601	2863	3119	3400	3655
96"	1306	1465	1492	1571	1651	1759	1844	1945	2029	2213	2389	2730	3073	3381	3687	4018	4318
108"	1421	1624	1658	1764	1867	1991	2127	2238	2348	2576	2808	3195	3581	3940	4292	4679	5029
120"	1508	1752	1854	1983	2102	2254	2397	2541	2677	2924	3200	3639	4055	4460	4863	5300	5696

**OPTIONS: NO EXTRA CHARGE**

- Vertical Application – Left or Right stack location

**VERTICAL APPLICATION STACK DESIGN SURCHARGES**

- Center Opening – Price as two separate shades.
- Center Stacking .....add \$92 each

## VERTICAL APPLICATION CONFIGURATION SPECIFICATIONS

NOTE: Use metal tape measure for all measurements. Measures to 1/8 inch.

### VERTICAL APPLICATION

- Fits rectangular window and door openings
- Opens and closes from side to side; ideal for sliding glass doors & French doors

• Four fabric stacking options:

- 1) left stack
- 2) right stack
- 3) center opening ("split stack")
- 4) center stack

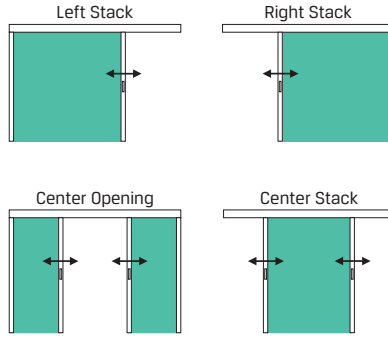

**Top Rail Dimensions**

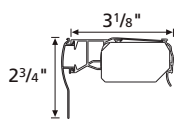

VERTICAL APPLICATION – SIZE STANDARDS				
	Honeycomb			2" Hybrid Pleat
	Sheer Fabric	All Other 3/4" Fabrics	All 3/4" Blackout Fabrics	All Fabrics
Min. Width	12"	12"	12"	12"
Max. Width <b>Side Stack</b>	120"	168"	168"	168"
Max. Width <b>Split Stack</b>	168"	190"	190"	190"
Min. Height	24"	24"	24"	24"
Max. Height	120"	120"	120"	120"
Max Sq. ft. <b>Side Stack</b>	100	140	120	100
Max Sq. ft. <b>Split Stack</b>	100	140	140	120

Vertical Application not available with any 3/8", 3/8" blackout, 3/4" semi sheer, 1/2" double cell, or 3/8" triple cell fabrics

NOTE: Stack is 6-1/2" space per side when fully opened, regardless of shade width.

#### FINISHED DIMENSIONS

Adjustments are taken from ordered dimensions.

	Honeycomb	2" Hybrid Pleat
<b>Inside (IB) Mount</b>		
Headrail unit	– 3/16"	– 3/16"
Shade height	– 1/2"	– 1/2"
Valance width (non-flush)	+ 1-1/4"	+ 1-1/4"
Valance width (flush)	– 1/8"	– 1/8"
<b>Outside (OB) Mount</b>		
Headrail unit	– 3/16"	– 3/16"
Shade height	ordered height	ordered height
Valance width	+ 1"	+ 1"
<b>Standard Returns</b>		
Outside Mount	3-1/8"	4-1/4"
Inside Non Flush Mount *	1-1/2"	1-1/2"

NOTE: Measurements may vary ± 1/8"

#### MOUNTING REQUIREMENTS

Use a metal tape measure for all measurements.

	Honeycomb	2" Hybrid Pleat
<b>Inside (IB) Mount</b>		
Minimum mounting depth	15/16"	15/16"
Minimum mounting depth, flush mount:	3-5/8"	4-1/2"
<b>Outside (OB) Mount</b>		
Minimum flat vertical surface	5/8"	5/8"

\*For each spacer block, 1/2" will be added to the length of the valance returns. For extension brackets, 2" will be added unless otherwise specified.

#### HARDWARE COLOR

- Hardware colors are currently limited to 10. Refer to the Hardware Color Guide for colors and more information.

#### EXCLUSIONS

- All 3/8" styles, 3/4" Semi Sheer, Double Cell, or Triple Cell honeycomb styles.

#### VERTICAL APPLICATION ORDERING NOTES

- Specify inside (IB), outside (OB), inside non flush mount or flush mount.
- Specify stacking configuration – left stack, right stack, center opening, or center stack. On split stack shades, both panels will be of equal width, unless otherwise specified. Center stacks are a surcharge option.
- Inside non flush mount valance returns are 1-1/2" if returns are selected\*
- Standard handle height is 40" to 50" from bottom of moving rail; specify any desired variation from this standard.
- Standard installation hardware (brackets) provided.

- Specify no-charge installation hardware:
  - Spacer blocks
  - Extension brackets
  - Shims (OB)
- Also refer to vertical application measuring in "General Information" section.

NOTE: Cut-outs can be done on movable and stationary rail. 1" is the only cut-out width available for Vertical Application shades. 6" is the maximum cut-out height and the height is measured from the floor to the top of the desired cut-out location.

Cut-outs are not available on 2" Hybrid Pleat.

**HONEYCOMB  
 CLASSIC SKYLIGHT A**

• 3/8" Marcella (H44) • 3/4" Marcella (H45) • 3/4" Radiance (HF6)

WIDTH TO:	24"	30"	36"	42"	48"	54"	60"	66"	72"
HEIGHT TO:									
36"	\$381	432	482	545	588	650	699	754	800
42"	400	460	522	582	643	701	761	807	858
48"	421	494	552	618	699	754	825	883	929
54"	452	524	593	662	752	797	883	942	1002
60"	466	556	634	706	811	865	947	1026	
66"	496	588	669	754	857	917	995		
72"	515	616	706	793	894	963	1057		

Prices in the 66" and 72" columns apply to side stack

↖ Skylight with Simplicity Motorization Maximum Width: 48"

- 3/8" Opulence (H40)
- 3/4" Cardiff (H91)
- 3/4" Glimmer (HS3)
- 3/4" Linen (H27)
- 3/4" Melodic (HX6)
- 3/4" Mirada (H92)
- 3/4" Opulence (H28)
- 3/4" Serene FR (H62)
- 1/2" Marcella (H47)

**HONEYCOMB  
 CLASSIC SKYLIGHT B**

WIDTH TO:	24"	30"	36"	42"	48"	54"	60"	66"	72"
HEIGHT TO:									
36"	\$448	508	567	639	687	763	819	888	938
42"	469	538	614	683	754	823	892	947	1007
48"	498	577	650	726	819	883	966	1041	1097
54"	533	616	699	777	881	934	1041	1110	1180
60"	549	653	738	830	952	1014	1113	1202	
66"	581	687	786	888	1002	1074	1170		
72"	605	722	830	931	1049	1129	1242		

Prices in the 66" and 72" columns apply to side stack

↖ Skylight with Simplicity Motorization Maximum Width: 48"

**OPTIONS: EXTRA CHARGE**

- Classic Skylight Extension Pole (extends 5' to 10') .....\$61

**STANDARD SIMPLICITY SURCHARGE AND OPTIONS  
 EXTRA CHARGE – SPECIFY ON ORDER  
 USE APPROPRIATE ARCH GRID FOR SHADE PRICE, THEN ADD EXTRA CHARGE(S) BELOW.**

- Standard Simplicity Motorization (Battery wand included in the price) .....add \$427 per shade
- 5 Channel Remote Control (Black Part #CS5138 or White Part #CS5138W).....add \$71 each
- 14 Channel TD/BU Remote – Available in White Only (Part #CS52136).....add \$107 each
- 48" Extension Wire (Part #CS5133Z) .....add \$13 each
- DC Power Supply (Part #CS5151).....add \$59 each

**SIMPLICITY RECHARGEABLE MOTORIZATION SURCHARGE AND OPTIONS  
 EXTRA CHARGE – SPECIFY ON ORDER  
 USE APPROPRIATE ARCH GRID FOR SHADE PRICE, THEN ADD EXTRA CHARGE(S) BELOW.**

- Simplicity Rechargeable Motorization .....add \$427 per shade
- 5 Channel Remote Control (Black Part #CS5138 or White Part #CS5138W).....add \$71 each
- 14 Channel TD/BU Remote – Available in White Only (Part #CS52136).....add \$107 each
- 48" Extension Wire (Part #CS5133Z) .....add \$13 each
- Solar Panel (Part #CS52096) .....add \$259 each
- Plug-In Charger (Part #CS5199).....add \$54 each

// Classic Skylight  
 // Skylight with Simplicity Motorization



**HONEYCOMB  
 CLASSIC SKYLIGHT C**

- 1/2" Opulence (H39)
- 3/4" Marcella Blackout (H46)
- 3/4" Radiance Blackout (HF7)

WIDTH TO:	24"	30"	36"	42"	48"	54"	60"	66"	72"
HEIGHT TO:									
36"	\$467	538	602	669	731	804	867	927	982
42"	501	568	648	722	802	871	942	1009	1069
48"	521	613	692	774	865	934	1021	1094	1157
54"	565	653	743	825	940	986	1101	1179	1249
60"	586	696	784	876	1003	1078	1184	1262	
66"	616	726	827	931	1062	1141	1255		
72"	650	772	873	986	1122	1205	1318		

Prices in the 66" and 72" columns apply to side stack

Skylight with Simplicity Motorization Maximum Width: 48"

**HONEYCOMB  
 CLASSIC SKYLIGHT D**

- 3/8" Opulence Blackout (H41)
- 3/4" Opulence Blackout (H29)
- 3/4" Peaceful (H96)
- 3/4" Serene FR Blackout (H60)
- 3/4" Tiffany (H25)
- 3/4" Tranquility (H24)

WIDTH TO:	24"	30"	36"	42"	48"	54"	60"	66"	72"
HEIGHT TO:									
36"	\$547	628	703	777	846	929	1003	1072	1141
42"	586	666	752	841	929	1009	1094	1175	1244
48"	614	710	804	894	998	1074	1179	1256	1336
54"	650	754	865	957	1080	1157	1262	1352	1440
60"	674	797	910	1012	1156	1240	1350	1451	
66"	719	844	973	1092	1225	1327	1453		
72"	754	881	1019	1140	1279	1393	1552		

Prices in the 66" and 72" columns apply to side stack

Skylight with Simplicity Motorization Maximum Width: 48"

OPTIONS: EXTRA CHARGE	
• Classic Skylight Extension Pole (extends 5' to 10')	\$61

STANDARD SIMPLICITY SURCHARGE AND OPTIONS EXTRA CHARGE – SPECIFY ON ORDER USE APPROPRIATE ARCH GRID FOR SHADE PRICE, THEN ADD EXTRA CHARGE(S) BELOW.	
• Standard Simplicity Motorization (Battery wand included in the price)	add \$427 per shade
– 5 Channel Remote Control (Black Part #CS5138 or White Part #CS5138W)	add \$71 each
– 14 Channel TD/BU Remote – Available in White Only (Part #CS52136)	add \$107 each
– 48" Extension Wire (Part #CS5133Z)	add \$13 each
– DC Power Supply (Part #CS5151)	add \$59 each

SIMPLICITY RECHARGEABLE MOTORIZATION SURCHARGE AND OPTIONS EXTRA CHARGE – SPECIFY ON ORDER USE APPROPRIATE ARCH GRID FOR SHADE PRICE, THEN ADD EXTRA CHARGE(S) BELOW.	
• Simplicity Rechargeable Motorization	add \$427 per shade
– 5 Channel Remote Control (Black Part #CS5138 or White Part #CS5138W)	add \$71 each
– 14 Channel TD/BU Remote – Available in White Only (Part #CS52136)	add \$107 each
– 48" Extension Wire (Part #CS5133Z)	add \$13 each
– Solar Panel (Part #CS52096)	add \$259 each
– Plug-In Charger (Part #CS5199)	add \$54 each



# CLASSIC SKYLIGHT CONFIGURATION SPECIFICATIONS

NOTE: Use metal tape measure for all measurements. Measures to 1/8 inch.

## CLASSIC SKYLIGHT

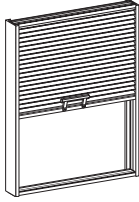

This easy to operate system holds shades in place. Perfect for skylights and other windows beyond reach.

- Hardware color: Aspen White (785)
- Manually operated with handle
- Ends of headrail, moving rail and anchor rail are enclosed by side tracks
- Features a two-cell fabric gasket attached to the headrail; eliminates light leakage when shade is closed
- 5' adjustable extension pole – extends to 10'

STACK LOCATION:			WINDOW POSITION:		
Top	Bottom	Side	Vertical	Sloped	Horizontal

Note: Pleats will have a vertical orientation when side stack is ordered.

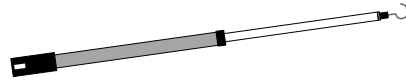

Optional Extension Pole  
Extends 5' to 10'  
(Part #400036-81511)

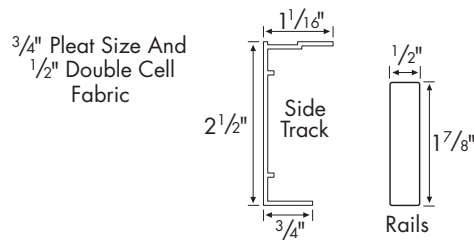
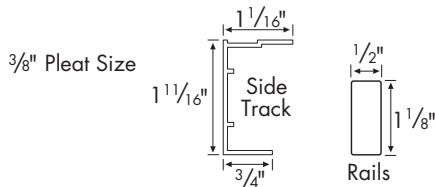

CLASSIC SKYLIGHT – SIZE STANDARDS	
	Honeycomb
	All Fabrics *
Min. Width	18"
Max. Width	60"
Min. Height	6"
Max. Height	72"
Max Area (sq. ft.)	25

\* Classic Skylight not available with any 3/8" triple cell or 2" Hybrid Pleat fabrics

NOTE: Shades over 36" wide require support cords.  
Rail stiffener is required when shade is over 42" wide.

CLASSIC SKYLIGHT SIDE STACK – SIZE STANDARDS	
	Honeycomb
	All Fabrics *
Min. Width	6"
Max. Width	72"
Min. Height	18"
Max. Height	60"
Max Area (sq. ft.)	25

\* Classic Skylight not available with any 3/8" triple cell or 2" Hybrid Pleat fabrics

### FINISHED DIMENSIONS

Adjustments are taken from ordered dimensions.

Inside (IB) Mount	
Headrail unit	- 3/16"
Shade height	ordered height
Fabric width	- 3/4"
Outside (OB) Mount	
Headrail unit	+ 3/4"
Shade height	ordered height
Fabric width	ordered width

NOTE: All finished dimensions include side tracks.

NOTE: Measurements may vary ± 1/8"

### MOUNTING REQUIREMENTS

Use a metal tape measure for all measurements.

<b>Inside (IB) Mounts</b>	3/8" Single
Minimum mounting depth IB:	1"
Minimum mounting depth, flush mount:	1-11/16"
<b>Outside (OB) Mount</b>	3/8" Single
Minimum flat vertical surface	5/8"
<b>Inside (IB) Mounts</b>	3/4" Single and 1/2" Double
Minimum mounting depth IB:	1-1/4"
Minimum mounting depth, flush mount:	2-1/2"
<b>Outside (OB) Mount</b>	3/4" Single and 1/2" Double
Minimum flat vertical surface	1"

# SKYLIGHT WITH SIMPLICITY MOTORIZATION CONFIGURATION SPECIFICATIONS

NOTE: Use metal tape measure for all measurements. Measures to 1/8 inch.

## SKYLIGHT WITH SIMPLICITY MOTORIZATION



### NOTE:

This is a different Skylight system than the Classic Skylight. Key differences include:

- Headrail and Bottomrail are identical and are the same rail used on standard shades with Simplicity Motorization
- Only available with fabric stack at the bottom of the window

### Features

- Inside Mount only
- White Tiara (661) aluminum head and bottom rails. White vinyl side rails
- Use radio frequency controlled Simplicity motors
- The Simplicity wireless remote control operates individual or groups of shades

### Operation & Installation Tips

- Shades installed into windows with metal casings may have a reduced radio frequency range, or may not operate at all
- Do not let the antenna on the motor touch any metal objects. This may interfere with signals from the remote control.
- Make sure to leave the top of the headrail open (motor exposed), do not cover; especially with metal materials. This could result in a reduced radio frequency range for the remote control or the shade may not operate at all.
- Skylights with Simplicity Motorization will NOT operate properly if installed in a completely horizontal application. The minimum recommended slope is 5%.



SKYLIGHT SIMPLICITY - SIZE STANDARDS	
	All Honeycomb Fabrics *
Minimum Width	18"
Maximum Width	48"
Minimum Height	12"
Maximum Height	72"

\* Skylight with Simplicity not available with 3/8" triple cell fabrics or 2" Hybrid Pleat

NOTE: Size Standards are the same for Skylight with standard Simplicity and Rechargeable Simplicity

### FINISHED DIMENSIONS

Adjustments are taken from ordered dimensions.

Inside (IB) Mount	
Headrail unit	- 3/16"
Shade height	ordered height
Fabric width	- 1-1/4"

NOTE: Measurements may vary  $\pm 1/8"$

### HEADRAIL & BOTTOMRAIL DIMENSIONS

Depth of Rail	2"
Depth of Rail & Bracket	2-1/4"
Depth of Rail, Side Tracks & Bracket	2-1/2"
Height of Rail	1-1/2"

### MOUNTING REQUIREMENTS

Use a metal tape measure for all measurements.

- Should not be more than 1/2" out of square to perform as intended
- The widest width of the window cannot exceed the narrowest width of the window by more than 3/8"
- The shade must be mounted with the fabric stack at the bottom or the lowest point in the window

### Standard Motorization

Inside (IB) Mounts	
Minimum mounting depth, IB	2-1/2"

### Rechargeable Motorization

Inside (IB) Mounts	
Minimum mounting depth, IB	
Over 20" wide	2-1/2"
Under 20" wide	3"

### NOTE:

Skylight shades with Rechargeable Motorization **over 20" wide** feature an internal battery with charging port. Skylight shades with Rechargeable Motorization **under 20" wide** require an external battery pack which accounts for the additional mounting depth

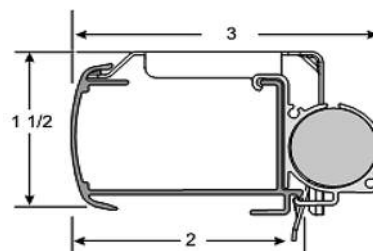

### HONEYCOMB ARCH A

• 3/8" Marcella (H44) • 3/4" Marcella (H45) • 3/4" Radiance (HF6)

WIDTH TO:	24"	30"	36"	42"	48"	54"	60"	66"	72"	78"	84"
Stationary	\$156	183	206	241	280	319	367	418	471	536	605
Movable*	232	266	303	344	395	453	512	581	650	747	857

\*Specify Fan-Fold or Top-Down Movable Arch when ordering

ALL 3/8" FAN-FOLD ARCHES  
N/A IN THESE SIZES

- 3/8" Opulence (H40)
- 3/4" Cardiff (H91)
- 3/4" Glimmer (HS3)
- 3/4" Linen (H27)
- 3/4" Melodic (HX6)
- 3/4" Mirada (H92)
- 3/4" Opulence (H28)
- 3/4" Serene FR (H62)
- 1/2" Marcella (H47)

### HONEYCOMB ARCH B

WIDTH TO:	24"	30"	36"	42"	48"	54"	60"	66"	72"	78"	84"
Stationary	\$186	211	241	284	326	376	430	490	554	630	710
Movable*	269	310	353	402	462	533	600	682	765	874	1003

\*Specify Fan-Fold or Top-Down Movable Arch when ordering

ALL 3/8" FAN-FOLD ARCHES  
N/A IN THESE SIZES

- 1/2" Opulence (H39)
- 3/4" Marcella Blackout (H46)
- 3/4" Radiance Blackout (HF7)

### HONEYCOMB ARCH C

WIDTH TO:	24"	30"	36"	42"	48"	54"	60"	66"	72"	78"	84"
Stationary	\$218	248	284	330	383	441	505	574	651	738	834
Movable*	315	365	414	473	544	627	706	800	896	1030	1182

\*Specify Fan-Fold or Top-Down Movable Arch when ordering

- 3/8" Opulence Blackout (H41)
- 3/4" Opulence Blackout (H29)
- 3/4" Serene FR Blackout (H60)
- 3/4" Tiffany (H25)
- 3/4" Tranquility (H24)

### HONEYCOMB ARCH D

WIDTH TO:	24"	30"	36"	42"	48"	54"	60"	66"	72"	78"	84"
Stationary	\$250	289	330	386	448	515	591	674	766	869	977
Movable*	368	429	487	556	636	731	828	936	1049	1203	1389

\*Specify Fan-Fold or Top-Down Movable Arch when ordering

ALL 3/8" FAN-FOLD ARCHES  
N/A IN THESE SIZES

NOTE: TRIPLE CELL FABRIC NOT AVAILABLE AS A TOP-DOWN ARCH  
2" HYBRID AND 3/4" PEACEFUL ARE NOT AVAILABLE AS ARCHES

#### OPTIONS: EXTRA CHARGE

- Top-Down Movable Arch Extension Pole (extends 5' to 10') .....\$61
- Arch and Elliptical Arch – price using width on Arch price charts for fabric desired.
- Rectangular Shade and Arch – price as 2 separate shades; One Arch and One Rectangular.

# SPECIALTY SIZE STANDARDS & MEASURING INFORMATION

NOTE: Use metal tape measure for all measurements. Measures to 1/8 inch.

## ARCHES

Refer to "Extra Charge Options" for Surcharge and Price Information

### INSIDE MOUNT

Locate shape below.  
Width: Measure exact width(s)  
Height: Measure exact height(s)

### OUTSIDE MOUNT

Locate shape below.  
Width: Measure desired width(s)  
Height: Measure desired height(s)

## FAN-FOLD ARCHES

### NON-MOVABLE ARCH (PERFECT ARCH = EXACT 1/2 CIRCLE, TEMPLATE REQUIRED)

#### FAN-FOLD STATIONARY PERFECT ARCH

Must be perfect arch.



Come standard with arch disc

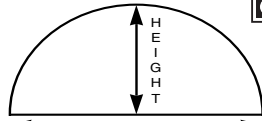

Width (Diameter)



	SIZE STANDARDS		
	Honeycomb		
	All 3/8" and 3/8" Blackout Fabrics	All 3/4" and 3/4" Blackout Fabrics	All 1/2" Double Cell and 3/8" Triple Cell Fabrics
Min. Width	12"	12"	12"
Max. Width	72"	84"	84"
Min. Height	6"	6"	6"
Max. Height	36"	42"	42"

Not available with 2" Hybrid Pleat or 3/4" Peaceful fabrics

### MOVABLE ARCH (PERFECT ARCH = EXACT 1/2 CIRCLE, TEMPLATE REQUIRED)

#### FAN-FOLD OPERABLE PERFECT ARCH

Must be perfect arch. Specify L or R arch orientation when ordering.

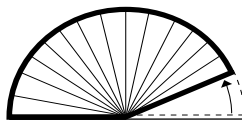

Shown Here – Fan Fold Left

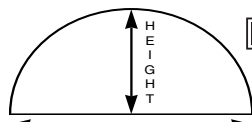

Width (Diameter)



	SIZE STANDARDS		
	Honeycomb		
	All 3/8" and 3/8" Blackout Fabrics	All 3/4" and 3/4" Blackout Fabrics	All 1/2" Double Cell and 3/8" Triple Cell Fabrics
Min. Width	12"	12"	12"
Max. Width	72"	84"	84"
Min. Height	6"	6"	6"
Max. Height	36"	42"	42"

Not available with 2" Hybrid Pleat or 3/4" Peaceful fabrics

Note: all fan-fold arches require the use of small, clear clips to be installed around the outer edge, which holds the fabric in place. The fabric must be slid out of the clips before the arch can be operated.

### NON-MOVABLE ELLIPTICAL ARCH (TEMPLATE REQUIRED)

#### FAN-FOLD STATIONARY ELLIPTICAL ARCH

Non-perfect arch.



Come standard with arch disc

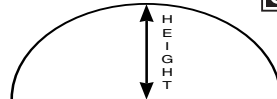

Width (Diameter)



	SIZE STANDARDS		
	Honeycomb		
	All 3/8" and 3/8" Blackout Fabrics	All 3/4" and 3/4" Blackout Fabrics	All 1/2" Double Cell and 3/8" Triple Cell Fabrics
Min. Width	12"	12"	12"
Max. Width	72"	84"	84"
Min. Height	1/4 width	1/4 width	1/4 width
Max. Height	1/2 width	1/2 width	1/2 width

Not available with 2" Hybrid Pleat or 3/4" Peaceful fabrics

Max height of straight sides is 10". Heights must be at least 25% of total width after the straight sides.

### TOP-DOWN MOVABLE ARCH (TEMPLATE REQUIRED)

#### TOP-DOWN OPERABLE PERFECT ARCH

Must be perfect arch. (Template required)

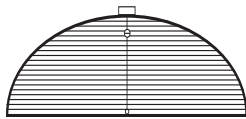

Fabric Pleats Oriented Horizontally.

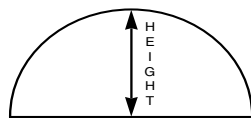

Width (Diameter)

	SIZE STANDARDS		
	Honeycomb		
	All 3/8" and 3/8" Blackout Fabrics	All 3/4" and 3/4" Blackout Fabrics	All 1/2" Double Cell Fabrics
Min. Width	18"	18"	18"
Max. Width	84"	84"	84"
Min. Height	6"	6"	6"
Max. Height	48"	48"	48"

Top-Down Movable Arch is not available with 3/8" triple cell, 2" Hybrid Pleat, or 3/4" Peaceful fabrics

#### Straight Side Specifications

- \* 3/8" & 3/4": if arch width wider than 66", the max height = 48"
- \* 1/2": if arch width wider than 66", the max height = 48"
- \* 1/2": if arch width wider than 72", the max height = 48"
- \* Non-perfect arch: heights must be at least 25% of total width



Optional Top-Down Movable Arch  
Extension Pole  
Extends 5' to 10' (Part #400037-0007)

Available as Inside (IB) Mount ONLY

Specify arch trim at order entry:  
661 Tiara White  
320 Rich Cream

NOTE: Top-Down Arch not available in Triple Cell fabrics

#### TOP-DOWN OPERABLE ELLIPTICAL ARCH

Non-perfect arch. (Template required)

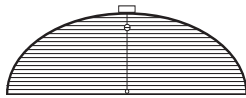

Fabric Pleats Oriented Horizontally.

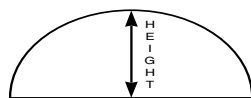

Width (Diameter)

	SIZE STANDARDS		
	Honeycomb		
	All 3/8" and 3/8" Blackout Fabrics	All 3/4" and 3/4" Blackout Fabrics	All 1/2" Double Cell Fabrics
Min. Width	18"	18"	18"
Max. Width	84"	84"	84"
Min. Arch Height	1/4 width	1/4 width	1/4 width
Max. Height	48"	48"	48"

Top-Down Movable Arch is not available with 3/8" triple cell, 2" Hybrid Pleat, or 3/4" Peaceful fabrics

Top-down arches will have a "flared" look to them when lowered. This is a natural characteristic of this product.

Arch trim kit included with Top-Down arches – available in White Tiara (661) & Rich Cream (320) – See the hardware guides for color example.

# SPECIALTY SIZE STANDARDS & MEASURING INFORMATION

NOTE: Use metal tape measure for all measurements. Measures to 1/8 inch.

## CIRCLES, QUARTER CIRCLES & ANGLE CUTS (TEMPLATE REQUIRED)

*Refer to "Extra Charge Options" for Surcharge and Price Information*

### INSIDE MOUNT

Locate shape of window.  
 Width: Measure exact width(s)  
 Height: Measure exact height(s)  
 Diagonal: Measure height of diagonal(s) (for Angle Cuts)

### OUTSIDE MOUNT

Locate shape of window.  
 Width: Measure desired width(s)  
 Height: Measure desired height(s)  
 Diagonal: Measure length of diagonal(s) (for Angle Cuts)

## CIRCLES & QUARTER CIRCLE (TEMPLATE REQUIRED)

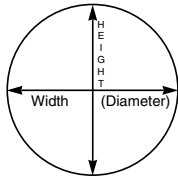

	All 3/8" & 3/4" Semi-Opaque Fabrics & All 1/2" Double Cell	3/8" Blackout	All Other
Min. Width	12"	12"	12"
Max. Width	48"	68"	60"
<b>NON-OPERABLE</b>			

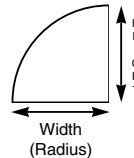

	All 3/8" Semi-Opaque Fabrics	All Other
Min. Width	12"	12"
Max. Width	30"	42"
<b>NON-OPERABLE</b>		

## ANGLE CUTS (TEMPLATE REQUIRED)

### ANGLED TOP (TEMPLATE REQUIRED)

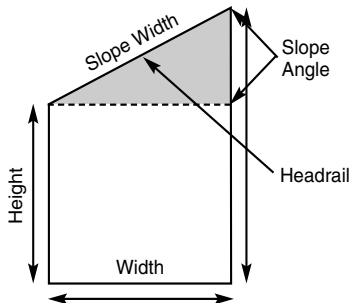

- Shades will raise to the shaded area indicated.
- Cordlock must always be at the lower end of the headrail

	All 3/8" Semi-Opaque Fabrics	All 3/4" Sheer, Semi-Sheer, Semi-Opaque Fabrics	All 3/8" & 3/4" Blackout Fabrics	All 1/2" Double Cell, 3/8" Triple Cell Fabrics
Maximum Height	84	84	72	84
Maximum Area (sq ft)	60	60	40	30
<b>MINIMUM SLOPE WIDTH</b>				
0 - 30 Angle	12	12	12	12
30 - 45 Angle	14	14	14	14
45 - 60 Angle	17	N/A	17	N/A
<b>MAXIMUM SLOPE WIDTH</b>				
0 - 30 Angle	83	55	83	60
30 - 45 Angle	84	67	84	60
45 - 60 Angle	84	N/A	84	N/A
Minimum Width	12	12	12	12
Maximum width	* up to 45 angle only			
0 - 30 Angle	70	48	70	48
30 - 45 Angle	60	48	60	48
45 - 60 Angle	42	N/A	42	N/A

\* 1/2" Up to 45 angle only

## HEXAGON & OCTAGON (TEMPLATE REQUIRED)

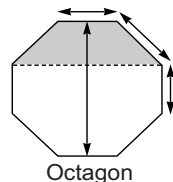
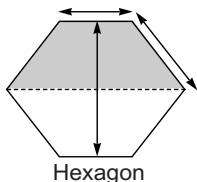

- Minimum width and minimum height – 8"
- Maximum width and maximum height – 30"
- Operate from bottom to top or top to bottom
- Inside mounts will raise to the shaded area indicated above

## TRAPEZOID (ALL PATTERNS) (TEMPLATE REQUIRED)

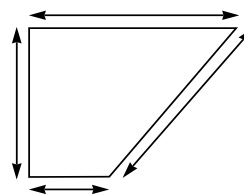

- Minimum width – 8"
- Maximum width of long rail – 72"
- Maximum reduction for short rail – 9" per side
- Maximum height – 96"
- Maximum area (sq. ft.) – 40
- Opens in the direction of the longest rail (Top-Down or Bottom-Up)

## OPTIONS: EXTRA CHARGE

- **Angle Cut** .....add \$199  
(includes Angle Top, Hexagon, Octagon & Trapezoid)
- **Circle** – price as (width price x 1.3) using the Stationary Arch price chart for the fabric desired. Use exact width desired when ordering. (Template required.)
- **Quarter Circle** – price as (width price x 1.3) using the Stationary Arch price chart for the fabric desired. Use exact width desired when ordering.

# SPECIALTY SIZE STANDARDS & MEASURING INFORMATION

NOTE: Use metal tape measure for all measurements. Measures to 1/8 inch.

## ARCHES & QUARTER CIRCLES

### FINISHED DIMENSIONS

Adjustments are taken from ordered dimensions.

Inside (IB) Mount	
Rail unit	- 3/16"
Arch height	ordered height
Fabric width	- 3/8"
Outside (OB) Mount	
Rail unit	+ 3/16"
Arch height	ordered height
Fabric width	ordered width

Max width for end mount is 36"

NOTE: Measurements may vary  $\pm$  1/8"

### MOUNTING REQUIREMENTS

Use a metal tape measure for all measurements.

Inside (IB) Mount	3/8" Single
Minimum mounting depth:	
Standard installation bracket	1"
Swivel bracket	1/2"
Minimum mounting depth, flush mount:	
Standard installation bracket	1-1/2"
Swivel bracket	1-1/8"
End mount bracket	1-1/8"
Outside (OB) Mount	3/8" Single
Minimum flat vertical surface	
	5/8"
Inside (IB) Mount	3/4" Single, 1/2" Double, 3/8" Triple
Minimum mounting depth:	
Standard installation bracket	1-1/4"
Swivel bracket	1/2"
Minimum mounting depth, flush mount:	
Standard installation bracket	2-1/4"
Swivel bracket	2"
End mount bracket	2"
Outside (OB) Mount	3/4" Single, 1/2" Double, 3/8" Triple
Minimum flat vertical surface	
	1"

## CIRCLES

### FINISHED DIMENSIONS

Adjustments are taken from ordered dimensions.

Inside (IB) Mount	
Rail unit	- 1/16"
Arch height	- 3/32"
Fabric width	- 3/8"
Outside (OB) Mount	
Rail unit	+ 3/32"
Arch height	+ 1/32"
Fabric width	ordered width

NOTE: Measurements may vary  $\pm$  1/8"

### MOUNTING REQUIREMENTS

Use a metal tape measure for all measurements.

Inside (IB) Mount	3/8" Single
Minimum mounting depth	
	1-1/8"
Inside (IB) Mount	3/4" Single, 1/2" Double, 3/8" Triple
Minimum mounting depth	
	1-7/8"
Outside (OB) Mount	3/4" Single, 1/2" Double, 3/8" Triple
Minimum flat vertical surface	
	5/8"

## ANGLES

### FINISHED DIMENSIONS

Finished dimensions vary depending on the degree of the angle.

NOTE: Measurements may vary  $\pm$  1/8"

### MOUNTING REQUIREMENTS

SAME AS ARCHES & QUARTER CIRCLES

## SPECIALTY SHAPES

### FINISHED DIMENSIONS

Adjustments are taken from ordered dimensions.

Inside (IB) Mount	
Rail unit	- 3/16"
Arch height	ordered height
Fabric width	- 3/8"
Outside (OB) Mount	
Rail unit	+ 3/16"
Arch height	ordered height
Fabric width	ordered width

NOTE: Measurements may vary  $\pm$  1/8"

### MOUNTING REQUIREMENTS

SAME AS ARCHES & QUARTER CIRCLES

# SIZE STANDARDS SUMMARY BY CONFIGURATION & FABRIC

HONEYCOMB							2" HYBRID PLEAT
3/8" Single Cell - Semi-Opaque	3/8" Single Cell - Blackout	3/4" Single Cell - Sheer and Semi-Sheer	3/4" Single Cell - Semi-Opaque	3/4" Single Cell - Blackout	1/2" Double Cell - Semi-Opaque	3/8" Triple Cell - Semi-Opaque	All Fabrics

**Standard Cordlock**

Min Width (net) *	8"	8"	8"	8"	8"	8"	8"	N/A
Max Width	60"	60"	60"	60"	60"	60"	60"	
Max Width - End Mount	36"	36"	36"	36"	36"	36"	36"	
Min Height	6"	6"	6"	6"	6"	6"	6"	
Max Height	144"	144"	144"	174"	174"	144"	120"	
Max Area (Sq/Ft)	60	40	60	60	40	40	40	

\* If width < 12", max height = 80"

**Standard Cordlock - Top-Down**

Min Width (net) *	10"	10"	10"	10"	10"	10"	10"	N/A
Max Width	60"	60"	60"	60"	60"	60"	60"	
Max Width - End Mount	36"	36"	36"	36"	36"	36"	36"	
Min Height	6"	6"	6"	6"	6"	6"	6"	
Max Height	144"	144"	144"	174"	174"	144"	120"	
Max Area (Sq/Ft)	60	40	60	60	40	40	60	

\* If width < 12", max height = 80"

**Standard Cordlock - Top-Down/ Bottom-Up**

Min Width (net) *	10"	10"	10"	10"	10"	10"	10"	N/A
Max Width	72"	72"	72"	72"	72"	72"	72"	
Max Width - End Mount	36"	36"	36"	36"	36"	36"	36"	
Min Height	6"	6"	6"	6"	6"	6"	6"	
Max Height	108"	108"	108"	108"	108"	108"	108"	
Max Area (Sq/Ft)	48	40	48	48	40	40	48	

\* If width < 12", max height = 80"

**Standard Cordlock - Two-Fabric Combo**

Min Width (net) *	N/A	N/A	10"	10"	10"	10"	10"	N/A
Max Width	N/A	N/A	72"	72"	72"	60"	60"	
Max Width - End Mount	N/A	N/A	36"	36"	36"	36"	36"	
Min Height	N/A	N/A	6"	6"	6"	6"	6"	
Max Height	N/A	N/A	96"	96"	96"	90"	90"	
Max Area (Sq/Ft)	N/A	N/A	48	48	40	40	40	

\* If width < 12", max height = 80"

**Standard Cordlock - Two-On-One Headrail**

Min Width (per panel) (net) *	8"	8"	8"	8"	8"	8"	8"	N/A
Min Width (overall)	16"	16"	16"	16"	16"	16"	16"	
Max Width (per panel)	60"	60"	60"	60"	60"	60"	60"	
Max Width (overall)	120"	120"	120"	120"	120"	120"	120"	
Max Width - End Mount	36"	36"	36"	36"	36"	36"	36"	
Min Height	6"	6"	6"	6"	6"	6"	6"	
Max Height	144"	144"	144"	174"	174"	144"	120"	
Max Area (Sq/Ft)	60	40	60	60	40	40	60	

\* If width < 12", max height = 80"

**Continuous Cord Loop**

Min Width (net)	18"	18"	18"	18"	18"	18"	18"	18"
Max Width	144"	144"	174"	174"	144"	144"	142"	120"
Max Width - End Mount	48"	48"	48"	48"	48"	48"	48"	42"
Min Height	6"	6"	6"	6"	6"	6"	6"	12"
Max Height	96"	96"	144"	144"	144"	144"	120"	120"
Max Area (Sq/Ft)	90	80	150	150	100	80	80	60

**Continuous Cord Loop - Top-Down/Bottom-Up**

Min Width (net)	24"	24"	24"	24"	24"	24"	24"	24"
Max Width	144"	144"	144"	144"	144"	144"	142"	120"
Max Width - End Mount	48"	48"	48"	48"	48"	48"	48"	42"
Min Height	8"	8"	8"	8"	8"	8"	8"	12"
Max Height	96"	96"	144"	144"	144"	144"	120"	120"
Max Area (Sq/Ft)	90	80	150	150	100	80	80	60

**Continuous Cord Loop - Two-On-One Headrail**

Min Width (per panel) (net)	18"	18"	18"	18"	18"	18"	18"	18"
Min Width (overall)	36"	36"	36"	36"	36"	36"	36"	36"
Max Width (per panel)	144"	144"	144"	144"	144"	144"	142"	102"
Max Width (overall)	174"	174"	174"	174"	174"	174"	174"	120"
Min Height	6"	6"	6"	6"	6"	6"	6"	12"
Max Height	96"	96"	144"	144"	144"	144"	120"	120"
Max Area (Sq/Ft)	90	80	150	150	100	80	80	60



# SIZE STANDARDS SUMMARY BY CONFIGURATION & FABRIC

HONEYCOMB							2" HYBRID PLEAT
3/8" Single Cell - Semi-Opaque	3/8" Single Cell - Blackout	3/4" Single Cell - Sheer and Semi-Sheer	3/4" Single Cell - Semi-Opaque	3/4" Single Cell - Blackout	1/2" Double Cell - Semi-Opaque	3/8" Triple Cell - Semi-Opaque	All Fabrics

### Cordless Lift System

Min Width (net)	16"	N/A	16"	16"	16"	16"	N/A	16"	
Max Width	120"		120"	120"	120"	120"		120"	120"
Max Width - End Mount	48"		48"	48"	48"	48"		48"	42"
Min Height	12"		12"	12"	12"	12"		12"	12"
Max Height	84"		84"	84"	84"	84"		84"	84"
Max Area (Sq/Ft)	70		70	70	70	70		70	60

### Cordless Lift - Two-On-One Headrail

Min Width (per panel) (net)	16"	N/A	16"	16"	16"	16"	N/A	16"	
Min Width (overall)	32"		32"	32"	32"	32"		32"	32"
Max Width (per panel)	120"		120"	120"	120"	120"		120"	100"
Max Width (overall)	174"		174"	174"	174"	174"		174"	120"
Min Height	12"		12"	12"	12"	12"		12"	12"
Max Height	84"		84"	84"	84"	84"		84"	84"
Max Area (per panel) (Sq/Ft)	70	70	70	70	70	70	60		

### Cordless Lift - Three-On-One Headrail

Min Width (per panel) (net)	16"	N/A	16"	16"	16"	16"	N/A	16"	
Min Width (overall)	32"		48"	48"	48"	48"		48"	48"
Max Width (per panel)	120"		120"	120"	120"	120"		120"	104"
Max Width (overall)	174"		174"	174"	174"	174"		174"	120"
Min Height	12"		12"	12"	12"	12"		12"	12"
Max Height	84"		84"	84"	84"	84"		84"	84"
Max Area (per panel) (Sq/Ft)	70	70	70	70	70	70	60		

### Cordless Lift System - Top-Down/ Bottom-Up

Min Width (net)	16"	N/A	16"	16"	16"	16"	N/A	16"	
Max Width	120"		120"	120"	120"	120"		120"	120"
Max Width - End Mount	48"		48"	48"	48"	48"		48"	42"
Min Height	12"		12"	12"	12"	12"		12"	12"
Max Height	84"		84"	84"	84"	84"		84"	84"
Max Area (Sq/Ft)	70		70	70	70	70		70	60

### Cordless Lift System - Two Fabric Combo

Min Width (net)	N/A	N/A	16"	16"	16"	N/A	N/A	N/A
Max Width			84"	84"	84"	N/A		
Max Width - End Mount			36"	36"	36"	N/A		
Min Height			12"	12"	12"	N/A		
Max Height			84"	84"	84"	N/A		
Max Area (Sq/Ft)			42	42	42	N/A		

### Cordless Lift & Lock

Min Width (net)	N/A	N/A	9.5"	9.5"	9.5"	9.5"	N/A	9.5"	
Max Width			84"	84"	84"	84"		84"	84"
Max Width - End Mount			48"	48"	48"	48"		48"	48"
Min Height			12"	12"	12"	12"		12"	12"
Max Height			84"	84"	84"	84"		84"	84"
Max Area (Sq/Ft)			49	49	49	49		49	49

### Cordless Lift & Lock - Two-On-One Headrail

Min Width (per panel) (net)	N/A	N/A	9.5"	9.5"	9.5"	9.5"	N/A	9.5"	
Min Width (overall)			20"	20"	20"	20"		20"	20"
Max Width (per panel)			84"	84"	84"	84"		84"	84"
Max Width (overall)			168"	168"	168"	168"		168"	168"
Min Height			12"	12"	12"	12"		12"	12"
Max Height			84"	84"	84"	84"		84"	84"
Max Area (per panel) (Sq/Ft)	49	49	49	49	49	49	49		

### Cordless Lift & Lock - Three-On-One Headrail

Min Width (per panel) (net)	N/A	N/A	9.5"	9.5"	9.5"	9.5"	N/A	9.5"	
Min Width (overall)			30"	30"	30"	30"		30"	30"
Max Width (per panel)			84"	84"	84"	84"		84"	84"
Max Width (overall)			168"	168"	168"	168"		168"	168"
Min Height			12"	12"	12"	12"		12"	12"
Max Height			84"	84"	84"	84"		84"	84"
Max Area (per panel) (Sq/Ft)	49	49	49	49	49	49	49		

### Cordless Lift & Lock - Top-Down/ Bottom-Up

Min Width (net)	N/A	N/A	16"	16"	16"	16"	N/A	16"	
Max Width			84"	84"	84"	84"		84"	84"
Max Width - End Mount			48"	48"	48"	48"		48"	48"
Min Height			12"	12"	12"	12"		12"	12"
Max Height			84"	84"	84"	84"		84"	84"
Max Area Overall (Sq/Ft)			49	49	49	49		49	49

# SIZE STANDARDS SUMMARY BY CONFIGURATION & FABRIC

HONEYCOMB							2" HYBRID PLEAT
3/8" Single Cell - Semi-Opaque	3/8" Single Cell - Blackout	3/4" Single Cell - Sheer and Semi-Sheer	3/4" Single Cell - Semi-Opaque	3/4" Single Cell - Blackout	1/2" Double Cell - Semi-Opaque	3/8" Triple Cell - Semi-Opaque	All Fabrics

### TriLight Shades - Continuous Cord Loop

Min Width (net)	N/A	N/A	N/A	24"	24"	24"	N/A	24"
Max Width				83" - 96"	83" - 96"	83" - 96"		83" - 96"
Max Width - End Mount				48"	48"	48"		42"
Min Height				12"	12"	12"		12"
Max Height				96"	96"	96"		96"
Max Area (Sq/Ft)				64	50	50		60

\* The HC fabric (bottom panel) max width can be reduced by the ordered PLE fabric (top panel), if PLE max width < HC max width.

\*\* Willa Sheer maximum width is 83"

### TriLight Shades - Cordless

Min Width (net)	N/A	N/A	N/A	16"	16"	16"	N/A	16"
Max Width				83" - 96"	83" - 96"	83" - 96"		83" - 96"
Max Width - End Mount				48"	48"	48"		42"
Min Height				12"	12"	12"		12"
Max Height				84"	84"	84"		84"
Max Area (Sq/Ft)				70	70	70		60

\* The HC fabric (bottom panel) max width can be reduced by the ordered PLE fabric (top panel), if PLE max width < HC max width.

\*\* Willa Sheer maximum width is 83"

### TriLight Shades - Cordless Lift & Lock

Min Width (net)	N/A	N/A	N/A	12"	12"	12"	N/A	12"
Max Width				84"	84"	84"		84"
Max Width - End Mount				48"	48"	48"		42"
Min Height				12"	12"	12"		12"
Max Height				84"	84"	84"		84"
Max Area (Sq/Ft)				49	49	49		49

\* The HC fabric (bottom panel) max width can be reduced by the ordered PLE fabric (top panel), if PLE max width < HC max width.

\*\* Willa Sheer maximum width is 83"

### Vertical Application

Min Width	N/A	N/A	12"	12"	12"	N/A	N/A	12"
Max Width <b>Side Stack</b>			120"	168"	168"			168"
Max Width <b>Split Stack</b>			168"	190"	190"			190"
Min Height			24"	24"	24"			24"
Max Height			120"	120"	120"			120"
Max Area <b>Side Stack</b>			100	140	120			100
Max Area <b>Split Stack</b>			100	140	140			120

Note: Sheer only, not available on Semi-Sheer.

# SIZE STANDARDS SUMMARY BY CONFIGURATION & FABRIC

HONEYCOMB							2" HYBRID PLEAT
3/8" Single Cell - Semi-Opaque	3/8" Single Cell - Blackout	3/4" Single Cell - Sheer and Semi-Sheer	3/4" Single Cell - Semi-Opaque	3/4" Single Cell - Blackout	1/2" Double Cell - Semi-Opaque	3/8" Triple Cell - Semi-Opaque	All Fabrics

## Classic Skylight

Min Width	18"	18"	18"	18"	18"	18"	N/A	N/A
Max Width	60"	60"	60"	60"	60"	60"		
Min Height	6"	6"	6"	6"	6"	6"		
Max Height	72"	72"	72"	72"	72"	72"		
Max Area (Sq/Ft)	25	25	25	25	25	25		

## Classic Skylight – Side Stack

Min Width	6"	6"	6"	6"	6"	6"	N/A	N/A
Max Width	72"	72"	72"	72"	72"	72"		
Min Height	18"	18"	18"	18"	18"	18"		
Max Height	60"	60"	60"	60"	60"	60"		
Max Area (Sq/Ft)	25	25	25	25	25	25		

## Skylight with Simplicity Motorization

Min Width	18"	18"	18"	18"	18"	18"	N/A	N/A
Max Width	48"	48"	48"	48"	48"	48"		
Min Height	12"	12"	12"	12"	12"	12"		
Max Height	72"	72"	72"	72"	72"	72"		
Max Area (Sq/Ft)	N/A	N/A	N/A	N/A	N/A	N/A		

## Non-Movable Perfect Arch (Fan-Fold)

Min Width	12"	12"	12"	12"	12"	12"	12"	N/A
Max Width	72"	72"	84"	84"	84"	84"	84"	
Min Height	6"	6"	6"	6"	6"	6"	6"	
Max Height	36"	36"	42"	42"	42"	42"	42"	

## Movable Perfect Arch (Fan-Fold)

Min Width	12"	12"	12"	12"	12"	12"	12"	N/A
Max Width	72"	72"	84"	84"	84"	84"	84"	
Min Height	6"	6"	6"	6"	6"	6"	6"	
Max Height	36"	36"	42"	42"	42"	42"	42"	

## Non-Movable Elliptical Arch (Fan-Fold)

Min Width	12"	12"	12"	12"	12"	12"	12"	N/A
Max Width	72"	72"	84"	84"	84"	84"	84"	
Min Height	1/4 width	1/4 width	1/4 width	1/4 width	1/4 width	1/4 width	1/4 width	
Max Height	36"	36"	42"	42"	42"	42"	42"	

## Top-Down Movable Perfect Arch

Min Width	18"	18"	18"	18"	18"	18"	N/A	N/A
Max Width	84"	84"	84"	84"	84"	84"		
Min Height	6"	6"	6"	6"	6"	6"		
Max Height	48"	48"	48"	48"	48"	48"		

## Top-Down Movable Elliptical Arch

Min Width	18"	18"	18"	18"	18"	18"	N/A	N/A
Max Width	84"	84"	84"	84"	84"	84"		
Min Height	1/4 width	1/4 width	1/4 width	1/4 width	1/4 width	1/4 width		
Max Height	48"	48"	48"	48"	48"	48"		

## Angle

Min Width	12"	12"	12"	12"	12"	12"	12"	N/A
Max Width	angle chart	angle chart	angle chart	angle chart	angle chart	angle chart	angle chart	
Max Height	angle chart	angle chart	angle chart	angle chart	angle chart	angle chart	angle chart	
Max Area (Sq/Ft)	60	40	60	60	40	30	30	

# PRODUCT COMPONENTS – STANDARD RECTANGULAR

3/8" End Mount Bracket (Part #2980038000) – Not Shown  
 3/4" End Mount Bracket (Part #2980050000) – Not Shown

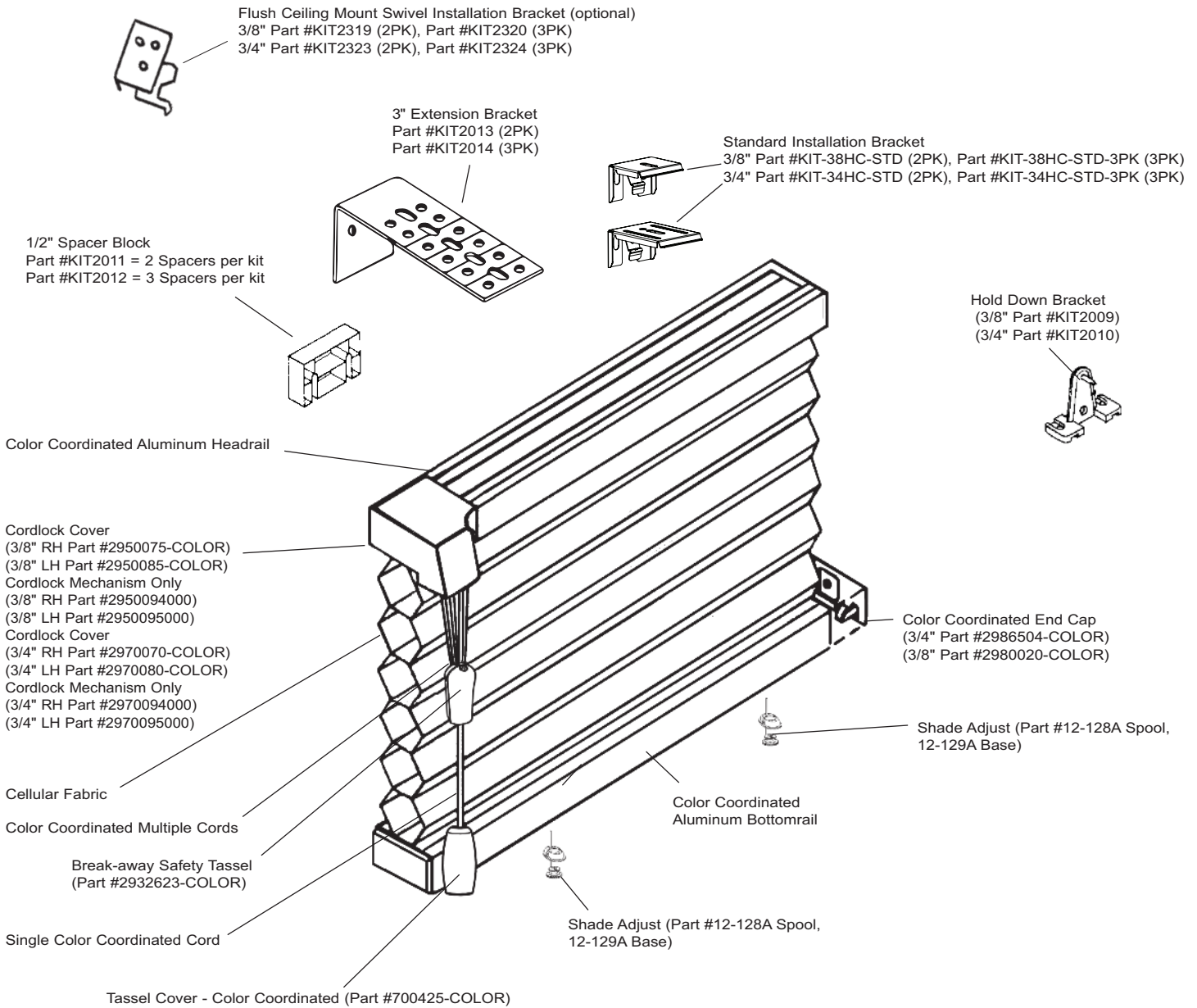

Arch Trim – White (Part #2280364661)  
 – Rich Cream (Part #2280364320)

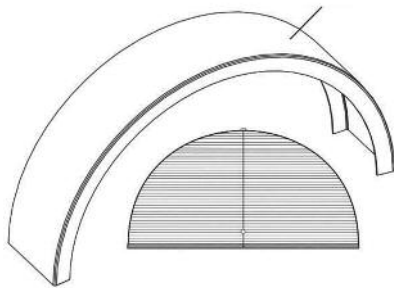

Child Safety Kit (Cord Cleat)  
 (Part #KIT2728)

# PRODUCT COMPONENTS – CORDLESS

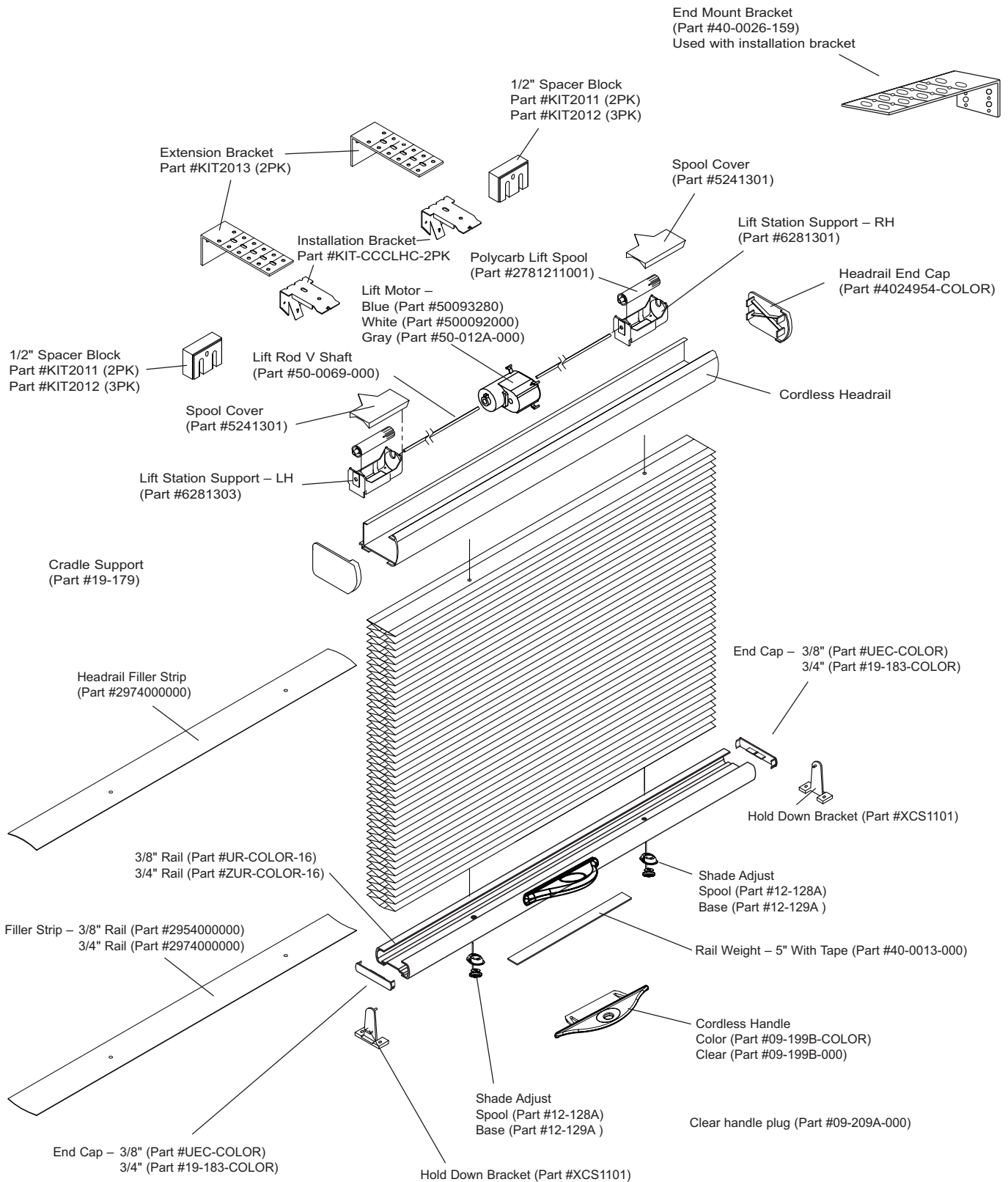

## CORDLESS TOP-DOWN/BOTTOM-UP

Striker Plate:  
Zinc: Part #CS5467PL-TDBU (Painted rails)  
White: Part #CS5467PL-TDBU-W (Fabric covered rails)

Magnet:  
Zinc: Part #CS5467 (Painted rails)  
Magnet Cover - White: Part #CS5467CV-W (Fabric covered rails)  
Magnet Lock: Part #CS5471  
Magnet Screw: Part #CS5474

# PRODUCT COMPONENTS – 2" HYBRID PLEAT

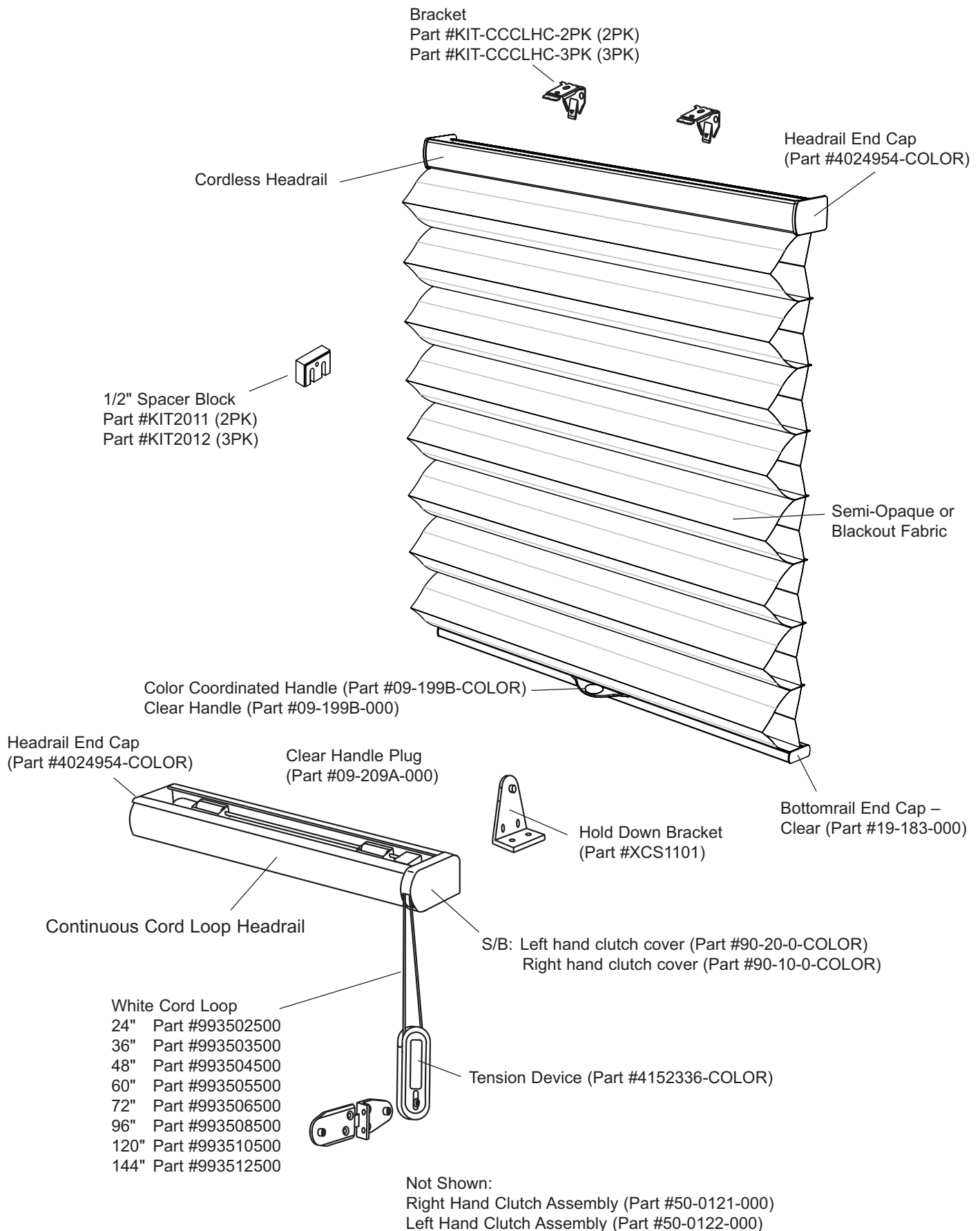

# PRODUCT COMPONENTS – CORDLESS LIFT & LOCK

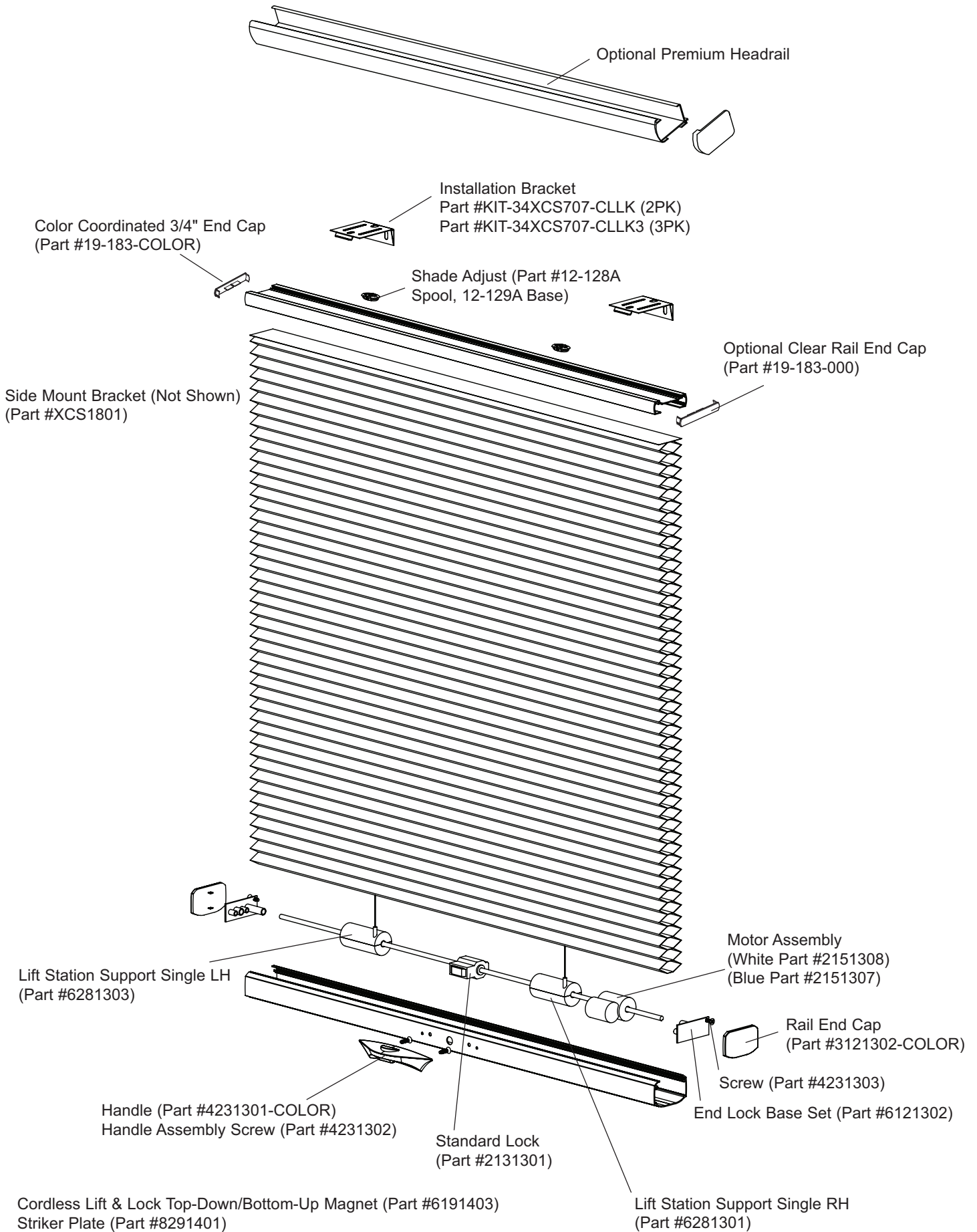



# PRODUCT COMPONENTS – CONTINUOUS CORD

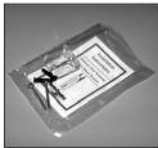
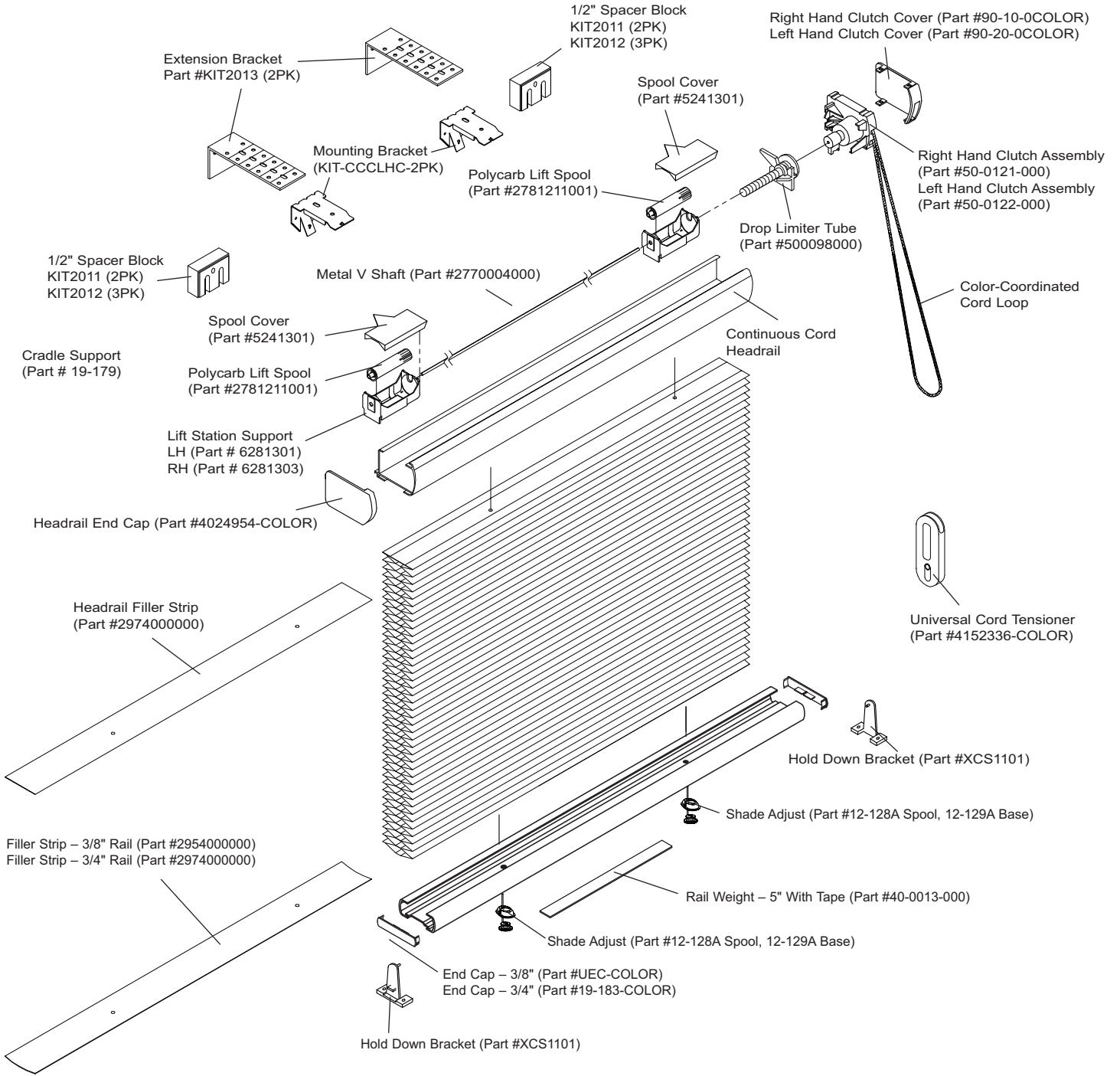

Universal Cord Tensioner Mounting Kit (Part #KIT2350)

**Continuous Cord Top-Down/Bottom-Up Components**

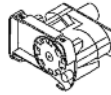

LH Rear Clutch Assembly (Part #CS4317)



Dual Bottom Limiter (Part #500199000)

# TRILIGHT PRODUCT COMPONENTS – CORDLESS & CONTINUOUS CORD LOOP

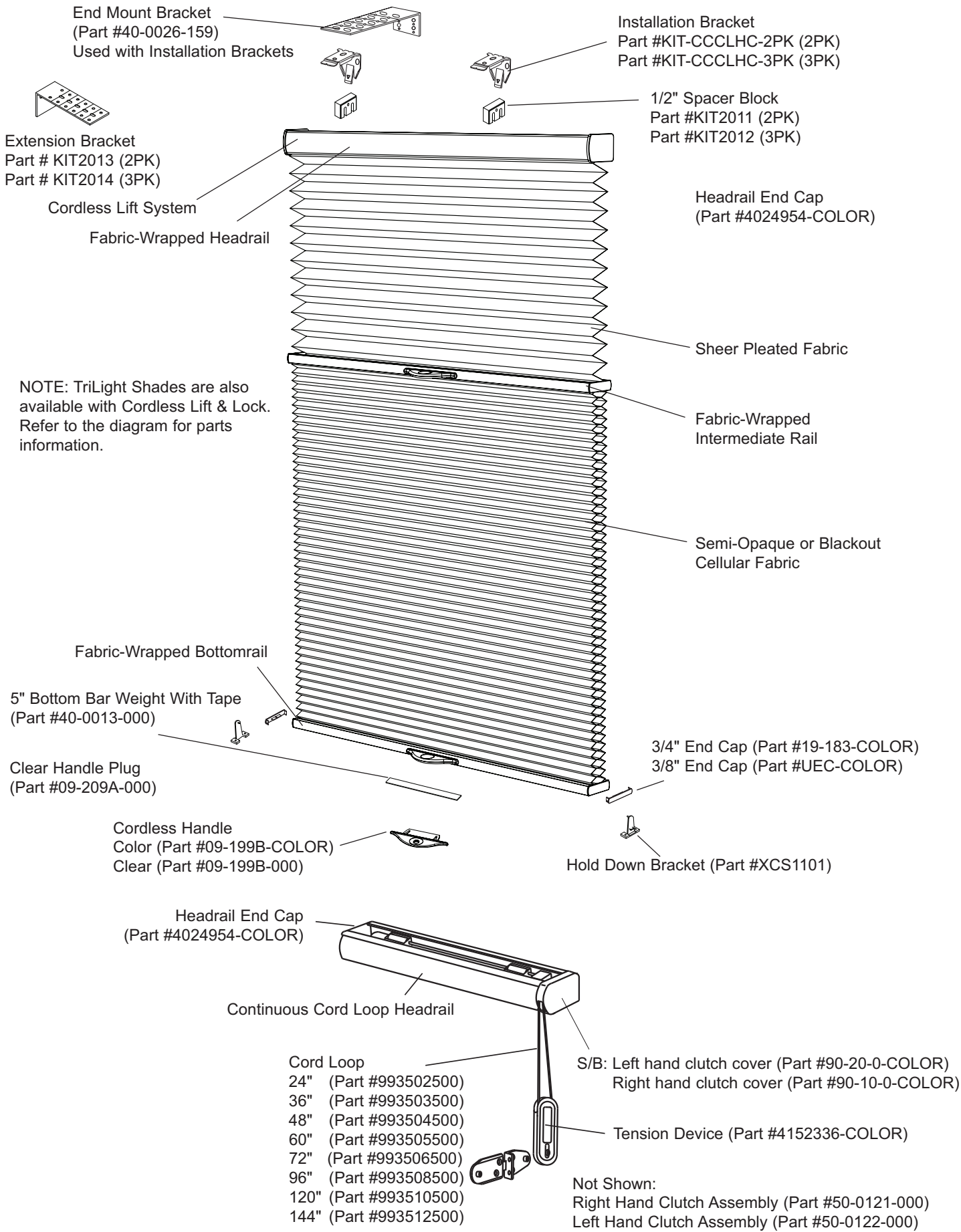

# PRODUCT COMPONENTS – 2" HYBRID PLEAT TRILIGHT

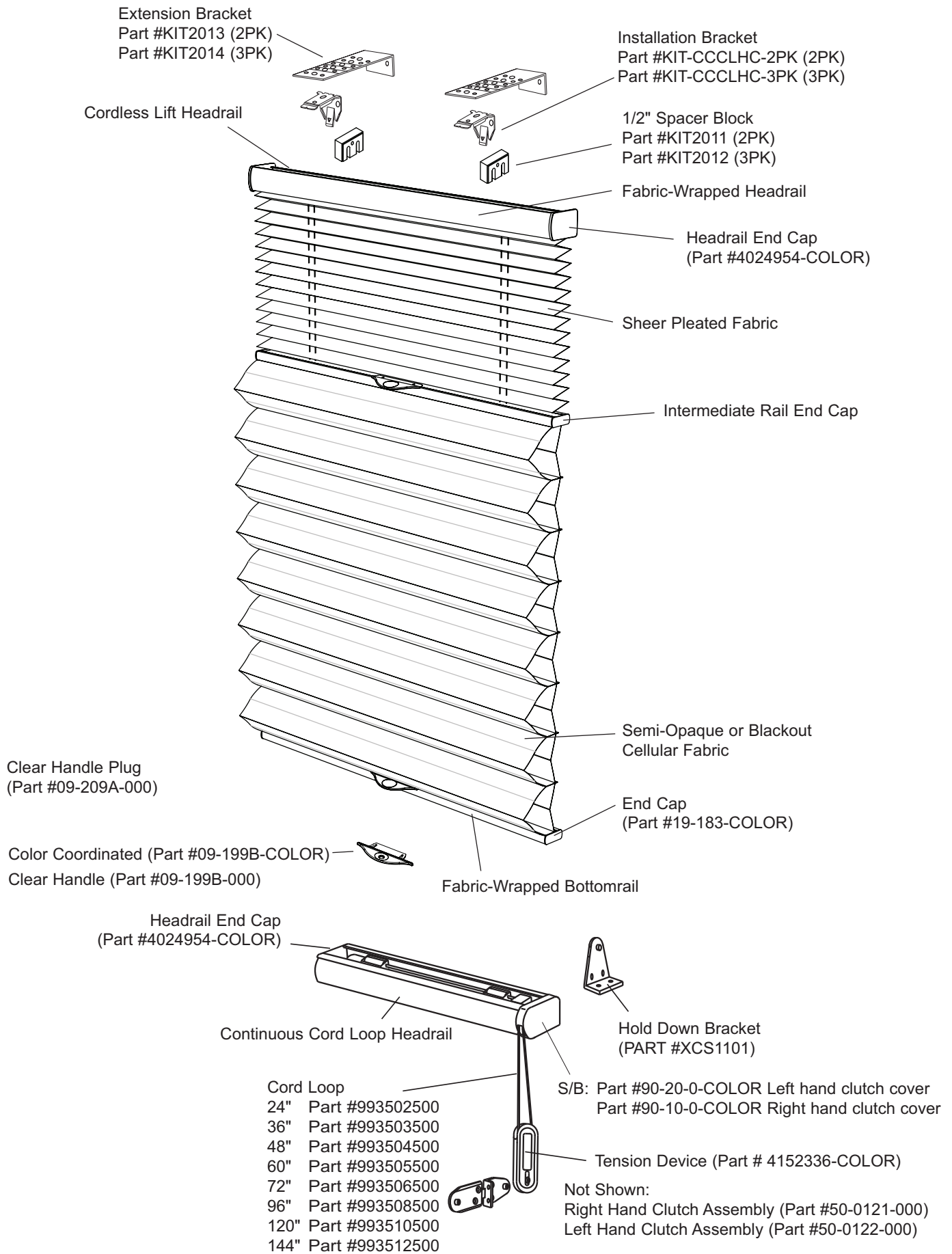

# PRODUCT COMPONENTS – SIMPLICITY RECHARGEABLE MOTORIZATION

End Mount Bracket  
(Part #40-0026-159)  
Used with installation bracket

1/2" Spacer Block  
Part #KIT2011 (2PK)  
Part #KIT2012 (3PK)

Extension Bracket  
Part #KIT2013 (2PK)

Installation Bracket  
Part #KIT-CCCLHC-2PK

Black Washer  
Lock Washer

Motor  
Spool Cover  
(Part #5241301)

Lift Station Support – RH  
(Part #6281301)

Headrail End Cap  
(Part #4024954-COLOR)

1/2" Spacer Block  
Part #KIT2011 (2PK)  
Part #KIT2012 (3PK)

3 Conductor Wire  
to PCB Pigtail

3 Conductor  
Extension Wire

Polycarb Lift Spool  
(Part #2781211001)

Cable Tie

Cable Twist Tie

Cable Tie  
Mounting Base

Charging Wire

Battery Pack

Spool Cover  
(Part #5241301)

Lift Station Support – LH  
(Part #6281303)

Lift Rod V Shaft  
(Part #50-0069-000)

Cordless Headrail

Cradle Support  
(Part #19-179)

Headrail Filler Strip  
(Part #2974000000)

End Cap – 3/8" (Part #UEC-COLOR)  
3/4" (Part #19-183-COLOR)

Hold Down Bracket (Part #XCS1101)

3/8" Rail (Part #UR-COLOR-16)  
3/4" Rail (Part #ZUR-COLOR-16)

Shade Adjust  
Spool (Part #12-128A)  
Base (Part #12-129A)

Rail Weight – 5" With Tape (Part #40-0013-000)

Filler Strip – 3/8" Rail (Part #2954000000)  
3/4" Rail (Part #2974000000)

Shade Adjust  
Spool (Part #12-128A)  
Base (Part #12-129A)

End Cap – 3/8" (Part #UEC-COLOR)  
3/4" (Part #19-183-COLOR)

Hold Down Bracket (Part #XCS1101)

Remote  
White (Part #CS5138W)  
Black (Part #CS5138)

Plug-in Charger  
(Part #CS5199)

## Simplicity Top-Down/Bottom-Up Components

- 14 Channel Remote (Part #CS52136)
- Primary Motor (Part #CS52132)
- Secondary Motor (Part #CS52133)
- Internal Battery Pack (Part #CS52134)
- Exterior Battery Pack (Part #CS52105)
- 6 Conductor Extension Wire (Part #CS52122)

# PRODUCT COMPONENTS – POWERWAND™ MOTORIZATION

End Mount Bracket  
(Part #40-0026-159)  
Used with installation bracket

1/2" Spacer Block  
Part #KIT2011 (2PK)  
Part #KIT2012 (3PK)

Extension Bracket  
Part #KIT2013 (2PK)

Installation Bracket  
Part #KIT-CCCLHC-2PK

Black Washer  
Lock Washer  
Motor

Spool Cover  
(Part #5241301)

Lift Station Support – RH  
(Part #6281301)

Headrail End Cap  
(Part #4024954-COLOR)

1/2" Spacer Block  
Part #KIT2011 (2PK)  
Part #KIT2012 (3PK)

Cable Tie

Cable Twist Tie

Polycarb Lift Spool  
(Part #2781211001)

Cordless Headrail

Battery Pack

Lift Rod V Shaft  
(Part #50-0069-000)

Hanger

2 Conductor Wire  
to PCB Pigtail

Spool Cover  
(Part #5241301)

Lift Station Support – LH  
(Part #6281303)

Internal Hanger

Cable Tie

Cradle Support  
(Part #19-179)

Pendant

Headrail Filler Strip  
(Part #2974000000)

End Cap – 3/8" (Part #UEC-COLOR)  
3/4" (Part #19-183-COLOR)

Hold Down Bracket (Part #XCS1101)

3/8" Rail (Part #UR-COLOR-16)  
3/4" Rail (Part #ZUR-COLOR-16)

Shade Adjust  
Spool (Part #12-128A)  
Base (Part #12-129A)

Filler Strip – 3/8" Rail (Part #2954000000)  
3/4" Rail (Part #2974000000)

Rail Weight – 5" With Tape (Part #40-0013-000)

Shade Adjust  
Spool (Part #12-128A)  
Base (Part #12-129A)

End Cap – 3/8" (Part #UEC-COLOR)  
3/4" (Part #19-183-COLOR)

Hold Down Bracket (Part #XCS1101)

Plug-in Charger  
(Part #CS5199)



# PRODUCT COMPONENTS – VERTICAL APPLICATION

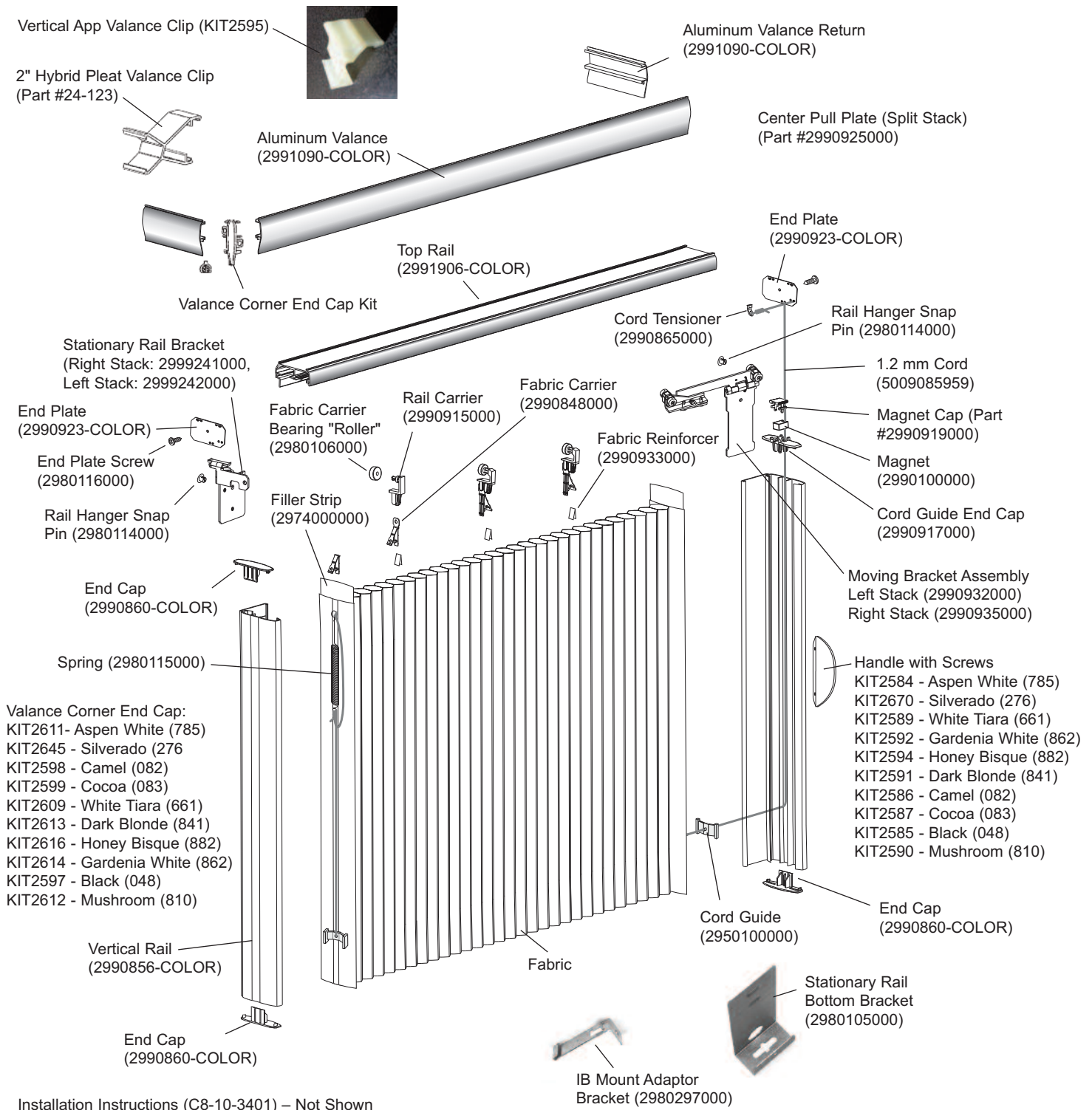

White Magnetic Strip (split stack) (2990133000)



Extension Bracket (40-0026-159)



Installation Bracket with Screws (2990934000)



Mounting Screws #6 x 1.5 (2980153000)



Shim (2990938785)



1/2" Spacer Block  
KIT2011 = 2 Spacers/kit  
KIT2012 = 3 Spacers/kit

# PRODUCT COMPONENTS – SKYLIGHT

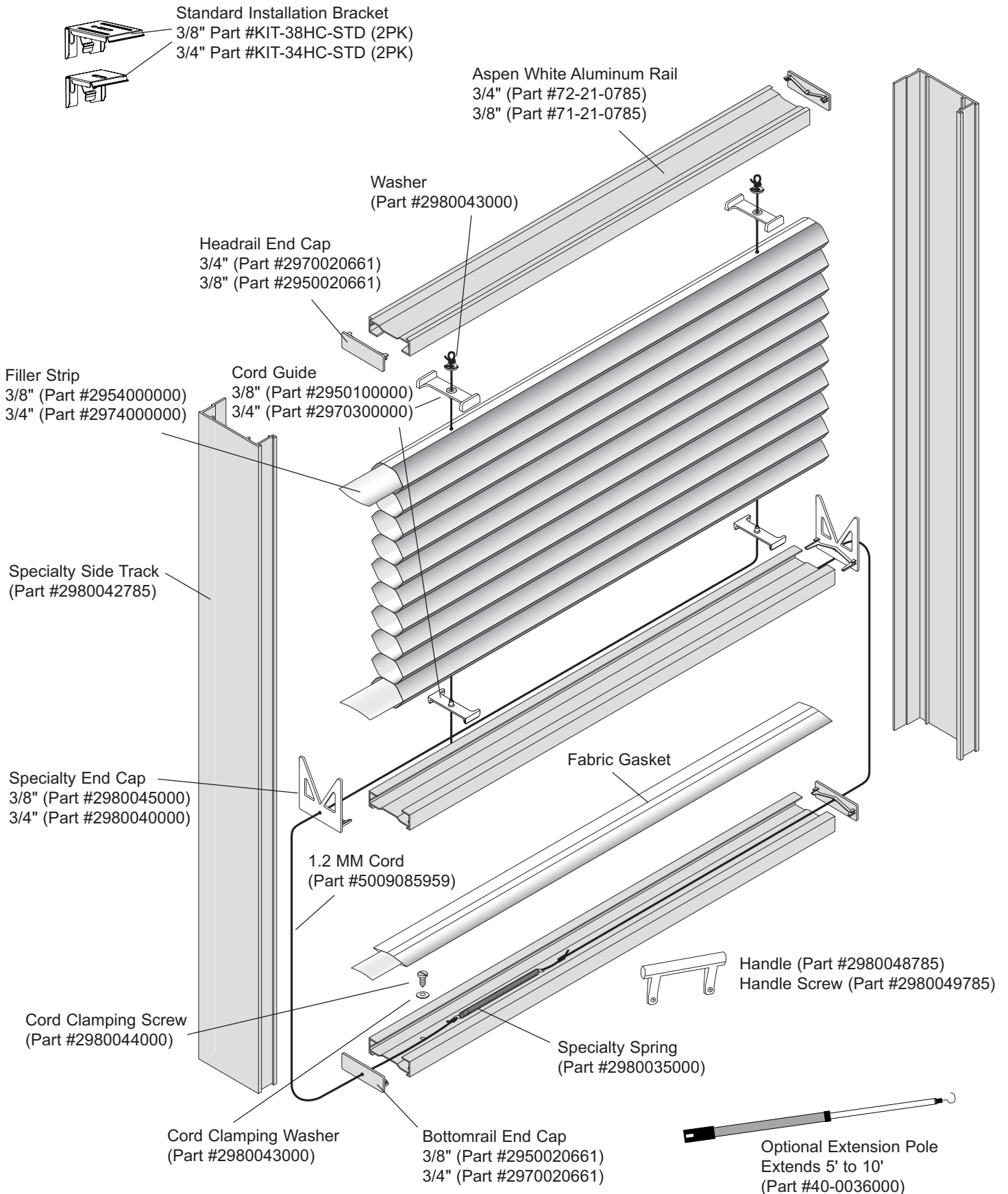



# PRODUCT COMPONENTS – SIMPLICITY SKYLIGHT

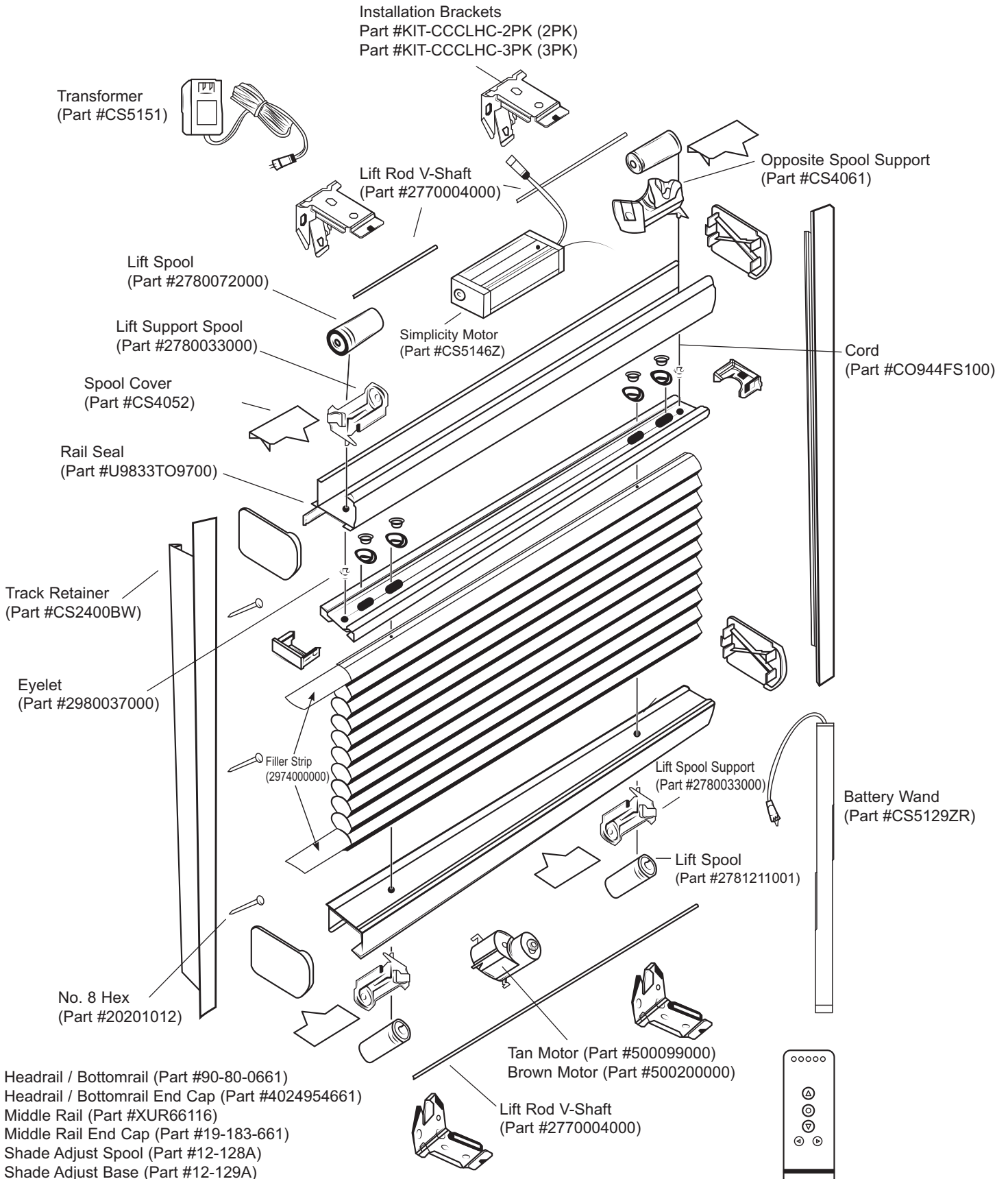

**Rechargeable Motor Components**  
Internal Battery Pack (Part #CS52101)  
Exterior Battery Pack (Part #CS52105)  
Plug-In Charger (Part #CS5199)  
Solar Charger (Part #CS52096)

Simplicity Remote – 5 Channel  
(Part #CS5138) – Black  
(Part #CS5138W) – White

Simplicity Remote – 14 Channel  
(Part #CS52136)