

TEXTON

SUGGESTED RETAIL PRICING

JANUARY, 2019

SOLARÉ

INTERIOR WINDOW SHADE COLLECTION



POWER ANY SHADE
UP TO
14 FEET WIDE X 14 FEET LONG
USING Volt[™] MOTORIZATION
NO POWER REQUIRED
USES RECHARGEABLE INTERNAL
LITHIUM ION BATTERIES

SOLARÉ SOLAR & DECORATIVE FABRICS

HIGH LIVING

WILSON COLLECTION

NEOLUX & VISION TRANSITIONAL SHADES

VISAGE

Solaré GT
GRAPHIC SHADES

SOLAR SCREEN MATERIALS TRANSLUCENT MATERIALS SHEER FABRICS ROOM DARKENING & BLACKOUT MATERIALS
MANUAL MOTORIZATION

TEXTON.COM 800-442-1540 FAX: 972-276-5104

TABLE OF CONTENTS

ROLLER SHADE MATERIAL SPECIFICATIONS.....3-6

NEOLUX TRANSITIONAL SHADE MATERIAL SPECIFICATIONS.....6

VISION TRANSITIONAL SHADE MATERIAL SPECIFICATIONS.....6

VISAGE SHADE MATERIAL SPECIFICATIONS.....6

FEATURES AND OPTIONS.....7-13

FABRIC ORIENTATION.....7

NEOLUX TRANSITIONAL SHADE DESCRIPTION.....8

TRIMS.....9-10

POLES & FINIALS.....11

SCALLOPS.....12

DECORATIVE PULLS.....13

ROLLER SHADE PRICE GRIDS.....14-33

NEOLUX TRANSITIONAL SHADE PRICE GRIDS.....34-35

VISION TRANSITIONAL SHADE PRICE GRIDS.....36-40

VISAGE TRANSITIONAL SHADE PRICE GRIDS.....41-43

SPECIFICATIONS & SIZE LIMITATIONS.....44-46

MOTORIZATION INFORMATION & CONTROL PRICING.....47

CARE AND CLEANING48

CHILD SAFETY.....48

WARRANTY.....48

MEASURING GUIDELINES (CONTINUED)

“ROUNDING” YOUR MEASUREMENTS

DIMENSIONS ON THE ORDER FORM SHOULD BE ACCURATE TO WITHIN 1/8”. GENERALLY, ROUND YOUR MEASUREMENTS UP TO THE NEAREST 1/8”. HOWEVER, WITH INSIDE MOUNTS, ALWAYS ROUND THE WIDTH MEASUREMENT DOWN TO THE NEAREST 1/8”. ROUNDING UP COULD RESULT IN A SHADE THAT IS TOO WIDE TO FIT WITHIN THE WINDOW OPENING. FOR EXAMPLE, FOR AN INSIDE MOUNT, 3/16” WOULD ROUND TO 1/8”.

MEASURING FOR INSIDE MOUNTS

- A. MEASURE THE WIDTH ABOUT 1 1/4” DOWN FROM THE TOP OF THE WINDOW, WHICH TYPICALLY IS WHERE THE INSTALLATION BRACKETS WILL BE MOUNTED. REMEMBER TO ROUND DOWN TO THE NEAREST 1/8”. THIS MEASUREMENT IS THE ORDERING WIDTH OF THE SHADE. DO NOT MAKE ANY DEDUCTIONS FROM THIS WIDTH – ALL NECESSARY DEDUCTIONS WILL BE MADE AUTOMATICALLY WHEN THE SHADE IS FABRICATED.
- B. MEASURE THE WIDTH AT THE CENTER AND BOTTOM OF THE WINDOW. IF THE WIDTH NARROWS BY MORE THAN 1” FROM THE TOP MEASUREMENT, THE CUSTOMER SHOULD CONSIDER AN OUTSIDE MOUNT.
- C. MEASURE THE HEIGHT OF THE WINDOW OPENING AT THREE LOCATIONS, AS SHOWN AT RIGHT, AND ORDER THE SHORTEST MEASUREMENT. AGAIN, MAKE NO DEDUCTIONS. ALL NECESSARY DEDUCTIONS WILL BE MADE WHEN THE SHADE IS FABRICATED.
- D. MEASURE WINDOW ON THE DIAGONAL. IF THE TWO DIAGONAL DIMENSIONS ARE NOT EXACTLY THE SAME, IT MAY BE MORE APPROPRIATE TO SPECIFY AN OUTSIDE MOUNT SHADE FOR OPTIMAL LIGHT CONTROL AND PRIVACY.

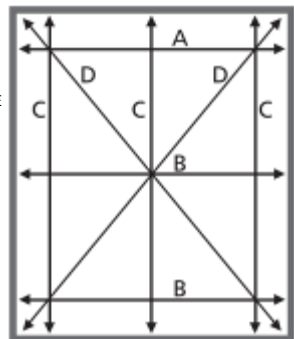
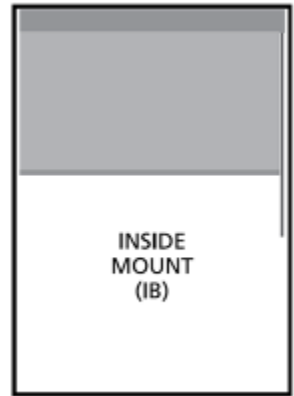

INSIDE MOUNT (IB)

- E. MEASURE DEPTH OF WINDOW FOR MOUNTING BRACKETS.

MEASURING FOR OUTSIDE & CEILING MOUNT

- MEASURE THE DESIRED WIDTH AND HEIGHT. TO MINIMIZE LIGHT LEAKAGE, IT IS RECOMMENDED THAT THE SHADE OVERLAP THE WINDOW OPENING AT LEAST 1 1/2” ON EACH SIDE, AS WELL AS AT THE TOP AND BOTTOM. AS WITH INSIDE MOUNTS, DO NOT MAKE ANY DEDUCTIONS FROM YOUR MEASUREMENTS.
- MEASURE THE WIDTH AT THE LOCATION WHERE YOU WANT THE ROLLER, AND USE THIS MEASUREMENT AS YOUR ORDERING WIDTH FOR THE SHADE. PLEASE NOTE THAT YOUR WINDOW SHADE FABRIC WILL BE 1” NARROWER UP TO A 72” WIDTH AND 1 1/2” NARROWER BEYOND THIS WIDTH DUE TO CLUTCH AND END PLUGS EXTENDING BEYOND ROLLER. (TAKE INTO ACCOUNT THAT A FLAT SURFACE 1/2” WIDE BY 1 1/2” HIGH IS REQUIRED TO MOUNT THE INSTALLATION BRACKETS.)
- MEASURE THE HEIGHT FROM WHERE THE TOP OF THE ROLLER WILL BE LOCATED TO WHERE YOU WANT THE BOTTOM OF THE SHADE.

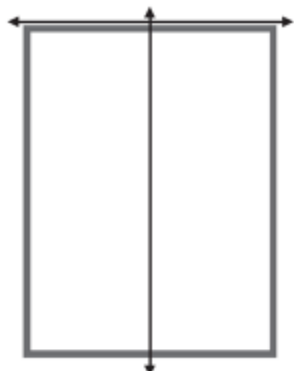
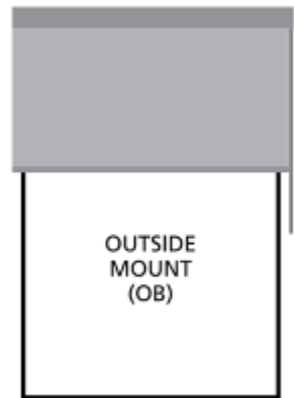

OUTSIDE MOUNT (OB)

MEASURING GUIDELINES

ACCURATE MEASUREMENTS ARE ABSOLUTELY ESSENTIAL. THE MEASUREMENTS YOU PROVIDE ARE USED FIRST TO PRICE THE SHADE, AND THEN TO CUSTOM FABRICATE IT TO THE SPECIFIED SIZE. THE DIMENSIONS SUPPLIED ON THE ORDER FORM MUST BE CORRECT FOR THE SHADE TO PROPERLY FIT THE WINDOW OPENING.

AS A DEALER, IT IS YOUR RESPONSIBILITY TO MEASURE AND ORDER ACCURATELY. YOUR FABRICATOR CANNOT BE HELD ACCOUNTABLE FOR INCORRECT MEASUREMENTS.

BASIC GUIDELINES

MEASURING FOR ROLLER SHADES IS SIMILAR TO MEASURING FOR MOST WINDOW COVERINGS. FOLLOW THESE BASIC GUIDELINES TO ENSURE A SMOOTH INSTALLATION:

- ALWAYS USE A STEEL TAPE MEASURE, PREFERABLY 3/4” TO 1” WIDE.
- MEASURE WIDTH FIRST, THEN HEIGHT.
- MEASURE EACH WINDOW SEPARATELY, EVEN IF THEY APPEAR TO BE THE SAME SIZE.
- SURVEY THE WINDOW AREA CAREFULLY AND MAKE ADDITIONAL MEASUREMENTS, IF NECESSARY. RECORD YOUR MEASUREMENTS ON A WORKSHEET.

INSIDE MOUNT, OUTSIDE MOUNT, & CLOTH WIDTH

HOW YOU TAKE YOUR MEASUREMENTS WILL VARY DEPENDING UPON WHETHER THE SHADE FITS WITHIN THE WINDOW OPENING (INSIDE MOUNT OR IB) OR OVERLAPS THE WINDOW OPENING (OUTSIDE MOUNT OR OB). WITH INSIDE MOUNTS, NOTE THAT THE SHADE FABRIC WILL BE ABOUT 1 1/4” NARROWER THAN THE WINDOW OPENING, SO IF COMPLETE PRIVACY AND LIGHT CONTROL IS DESIRED, DRAPERY SIDE PANELS SHOULD BE INSTALLED OVER THE SHADE. CLOTH WIDTH MERELY INDICATES WHAT THE EXACT MATERIAL WIDTH SHOULD BE. WITH CLOTH WIDTH, THE BRACKETS WILL MEASURE WIDER THAN THE MATERIAL.

MATERIAL COLLECTION							MATERIAL COLLECTIONS CONTINUE ON NEXT PAGE.
FABRIC DESCRIPTION	OPENNESS	FR RATED	WIDTH	RAILROAD	SAMPLED IN	PG	
3000 CA 3%	3%	YES	98"	YES	ALKENZ	3	
3000 HT 3%	3%	YES	118"	YES	ALKENZ	3	
3000 HT 5%	5%	YES	98"	YES	ALKENZ	3	
3000 NET 1%	1%	YES	118"	YES	ALKENZ	3	
3000 NET 10%	10%	YES	118"	YES	ALKENZ	3	
3000 NET 3%	3%	YES	118"	YES	ALKENZ	3	
3000 NET 5%	5%	YES	118"	YES	ALKENZ	3	
3000 RR 3%	3%	YES	98"	YES	ALKENZ	3	
3000 SS 3%	3%	YES	98"	YES	ALKENZ	3	
4000 L,W 5%	5%	YES	98"	YES	ALKENZ	3	
4000 NET 10%	10%	YES	118"	YES	ALKENZ	3	
4000 NET 3%	3%	YES	118"	YES	ALKENZ	3	
4000 NET 5%	5%	YES	118"	YES	ALKENZ	3	
4700 P,Q <1%	1%	YES	118"	YES	ALKENZ	3	
ALLURE BLACKOUT	BLACKOUT	YES	98"	YES	SOLARÉ (NEW 2018 BOOK)	2	
AURA	TRANSLUCENT	NO	80"	NO	SOLARÉ (NEW 2018 BOOK)	3	
AYANA	72"	NO	72"	NO	SOLARÉ (NEW 2018 BOOK)	6	
BALI	SHEER	NO	86"	NO	SOLARÉ (NEW 2018 BOOK)	8	
BAMBOO	TRANSLUCENT	NO	98"	NO	HIGH LIVING	5	
BANBURY	TRANSLUCENT	NO	86"	NO	SOLARÉ (NEW 2018 BOOK)	7	
BASIX	TRANSLUCENT	NO	80"	YES	SOLARÉ (NEW 2018 BOOK)	4	
BASIX	BLACKOUT	NO	80"	YES	SOLARÉ (NEW 2018 BOOK)	7	
BEVERLY	TRANSLUCENT	NO	78"	NO	SOLARÉ	6	
BIMINI TRANSLUCENT	TRANSLUCENT	NO	98"	NO	VERTILUX	2	
BIMINI BLACKOUT	BLACKOUT	NO	98"	NO	VERTILUX	3	
BOSTON II	TRANSLUCENT	NO	110"	NO	WILSON	5	
BOSTON II	BLACKOUT	NO	110"	NO	WILSON	7	
BRESLYN	BLACKOUT	NO	110"	NO	SOLARÉ	8	
BROMUS 5%	5%	YES	118"	YES	SOLARÉ (NEW 2018 BOOK)	2	
BROOM II	TRANSLUCENT	NO	110"	YES	WILSON	5	
BROOM II	BLACKOUT	NO	110"	YES	WILSON	7	
CARNIVAL	TRANSLUCENT	YES	82"	YES	SOLARÉ (NEW 2018 BOOK)	7	
CHATSWORTH	SHEER	NO	78"	YES	SOLARÉ (NEW 2018 BOOK)	7	
CHENILLE	BLACKOUT	NO	80	NO	SOLARÉ (NEW 2018 BOOK)	9	
CLASSIC SCREEN 3%	3%	YES	118"	YES	ROLLEASE	3	
CLASSIC SCREEN 5%	5%	YES	118"	YES	ROLLEASE	2	
CLASSIC TIMELESS	BLACKOUT	YES	72"	YES	SOLARÉ	1	
COLLINA	BLACKOUT	NO	80"	YES	SOLARÉ (NEW 2018 BOOK)	10	
COLOURTEX	TRANSLUCENT	YES	82"	NO	SOLARÉ (NEW 2018 BOOK)	5	
COLOURTEX	BLACKOUT	YES	82"	NO	SOLARÉ (NEW 2018 BOOK)	7	
BLACKOUT COMO	TRANSLUCENT	YES	78"	NO	SOLARÉ (NEW 2018 BOOK)	6	
CONCORD II CONCORD	TRANSLUCENT	NO	118"	YES	WILSON	5	
II	BLACKOUT	NO	118"	YES	WILSON	7	
CONTEX SPC	TRANSLUCENT	YES	78	NO	SOLARÉ (NEW 2018 BOOK)	5	
CORAL	TRANSLUCENT	NO	80	NO	SOLARÉ (NEW 2018 BOOK)	5	
DAPPLE SPC	TRANSLUCENT	YES	78"	NO	SOLARÉ (NEW 2018 BOOK)	3	
DAYBREAK	TRANSLUCENT	YES	118	NO	SOLARÉ (NEW 2018 BOOK)	6	
DECO SCREEN 5%	5%	YES	98"	NO	SOLARÉ	6	
ECO PLANET	3%	YES	106	NO	VERTILUX	6	
ESFRON	SHEER	YES	110"	NO	SOLARÉ	4	
FARRAH	BLACKOUT	NO	80"	NO	SOLARÉ (NEW 2018 BOOK)	9	
FLUTTER	SHEER	NO	80"	YES	SOLARÉ (NEW 2018 BOOK)	5	
FURY	SHEER	NO	118"	YES	SOLARÉ	7	
G RAFF	BLACKOUT	NO	78"	NO	SOLARÉ (NEW 2018 BOOK)	8	
GUARDIAN	BLACKOUT	YES	78"	NO	SOLARÉ (NEW 2018 BOOK)	1	
HAMPTON	TRANSLUCENT	NO	110"	NO	SOLARÉ (NEW 2018 BOOK)	6	
HARMONY	TRANSLUCENT	NO	98"	NO	SOLARÉ (NEW 2018 BOOK)	5	

MATERIAL COLLECTION							MATERIAL COLLECTIONS CONTINUE ON NEXT PAGE.
FABRIC DESCRIPTION	OPENNESS	FR RATED	WIDTH	RAILROAD	SAMPLED IN	PG	
HARMONY BLACKOUT	BLACKOUT	NO	98"	NO	SOLARÉ (NEW 2018 BOOK)	7	
HAVEN	SHEER	NO	82"	NO	SOLARÉ	4	
HELSINKI	SHEER	YES	78"	NO	SOLARÉ (NEW 2018 BOOK)	9	
HIGHLAND	BLACKOUT	NO	78"	NO	SOLARÉ (NEW 2018 BOOK)	10	
IBIZA	TRANSLUCENT	NO	98"	NO	HIGH LIVING	5	
IMAGINE	BLACKOUT	YES	114"	YES	HIGH LIVING	5	
KIANA	TRANSLUCENT	NO	94"	NO	SOLARÉ	4	
LINEN	TRANSLUCENT	NO	72"	NO	SOLARÉ (NEW 2018 BOOK)	7	
LINEN LIGHT	TRANSLUCENT	NO	94"	NO	SOLARÉ	4	
LINENWEAVE	TRANSLUCENT	NO	94"	NO	SOLARÉ	4	
LOUVOSCREEN + 3%	3%	YES	98"	YES	SOLARÉ (NEW 2018 BOOK)	7	
LOUVOSCREEN + 5%	5%	YES	98"	YES	SOLARÉ (NEW 2018 BOOK)	7	
LYLITH	SHEER	NO	110"	NO	SOLARÉ	8	
MADRID SPC	TRANSLUCENT	NO	78"	NO	SOLARÉ (NEW 2018 BOOK)	4	
MAGNOLIA	BLACKOUT	NO	80"	NO	SOLARÉ (NEW 2018 BOOK)	10	
MAINE	BLACKOUT	YES	110"	NO	SOLARÉ (NEW 2018 BOOK)	8	
MALACCA	TRANSLUCENT	NO	94"	NO	SOLARÉ	4	
MATTIZ	TRANSLUCENT	YES	78"	NO	VERTILUX	3	
MERCURY II	TRANSLUCENT	NO	110"	YES	WILSON	5	
MERCURY II	BLACKOUT	NO	110"	YES	WILSON	7	
MINERAL	TRANSLUCENT	NO	78"	NO	SOLARÉ (NEW 2018 BOOK)	5	
MISTRAL	SHEER	NO	106"	NO	HIGH LIVING	4	
MONTEREY	SHEER	NO	110"	NO	SOLARÉ (NEW 2018 BOOK)	6	
NEWPORT	TRANSLUCENT	NO	80"	NO	SOLARÉ (NEW 2018 BOOK)	8	
NIGHT NIGHT	BLACKOUT	NO	80"	NO	SOLARÉ (NEW 2018 BOOK)	8	
NORDICSCREEN PLUS BW 1%	1%	YES	118"	NO	SOLARÉ	2	
NORDICSCREEN PLUS BW 10%	10%	YES	118"	YES	SOLARÉ	1	
NORDICSCREEN PLUS BW 3%	3%	YES	118"	YES	SOLARÉ	2	
NORDICSCREEN PLUS BW 5%	5%	YES	118"	YES	SOLARÉ	2	
NORDICSCREEN PLUS TWILL 1%	1%	YES	118"	YES	SOLARÉ	2	
NORDICSCREEN PLUS TWILL 3%	3%	YES	118"	YES	SOLARÉ	2	
ODA	SHEER	NO	98"	NO	HIGH LIVING	7	
OPEN LINEN	SHEER	NO	82"	YES	SOLARÉ (NEW 2018 BOOK)	6	
OSLO	BLACKOUT	NO	110"	NO	SOLARÉ	3	
OSLO	TRANSLUCENT	YES	118"	NO	SOLARÉ (NEW 2018 BOOK)	7	
PALISTER	SHEER	NO	96"	NO	SOLARÉ	8	
PARADISE	BLACKOUT	NO	80"	NO	SOLARÉ (NEW 2018 BOOK)	9	
PARTY ANIMALS	BLACKOUT	NO	78"	NO	SOLARÉ (NEW 2018 BOOK)	8	
PEBBLES	BLACKOUT	NO	80"	NO	SOLARÉ (NEW 2018 BOOK)	9	
PERSIS 8%	8%	YES	118"	YES	SOLARÉ (NEW 2018 BOOK)	3	
PLANET FR	TRANSLUCENT	YES	106"	NO	HIGH LIVING	6	
PRIMARY BLACKOUT	BLACKOUT	YES	80	NO	SOLARÉ (NEW 2018 BOOK)	6	
REGAL	12%	YES	118"	NO	SOLARÉ	3	
REGATTA	BLACKOUT	YES	68"	NO	SOLARÉ (NEW 2018 BOOK)	7	
REGENCY SPC	TRANSLUCENT	YES	78"	NO	SOLARÉ (NEW 2018 BOOK)	6	
RITZ	TRANSLUCENT	NO	80"	NO	SOLARÉ (NEW 2018 BOOK)	6	
ROME	SHEER	NO	78"	YES	HIGH LIVING	4	
S SCREEN 4%	4%	YES	98"	NO	SOLARÉ	6	
SAMOA	BLACKOUT	NO	98"	NO	HIGH LIVING	6	
SATIN	BLACKOUT	NO	76"	YES	SOLARÉ	5	
SCALA	BLACKOUT	NO	110"	YES	SOLARÉ	3	
SCREEN 3000 BLACKOUT FR	BLACKOUT	YES	118"	YES	SOLARÉ	5	

* PLEASE NOTE: FABRIC MAY COME IN WIDER WIDTHS. HOWEVER, THESE WIDER WIDTHS ARE NOT REGULARLY STOCKED. CONTACT TEXTON CUSTOMER SERVICE FOR ASSISTANCE.

MATERIAL COLLECTION

MATERIAL COLLECTIONS CONTINUE ON NEXT PAGE.

FABRIC DESCRIPTION	OPENNESS	FR RATED	WIDTH	RAILROAD	SAMPLED IN	PG
SHEERWEAVE 2000	5%	YES	96" *	YES	PHIFER	6
SHEERWEAVE 2100	10%	YES	96"	YES	PHIFER	6
SHEERWEAVE 2360	10%	YES	98"	YES	PHIFER	6
SHEERWEAVE 2390	5%	YES	98" *	YES	PHIFER	6
Sheerweave 2410	3%	YES	98"	YES	Phifer	6
Sheerweave 2500	1%	YES	98" *	YES	Phifer	7
Sheerweave 2701	1%	YES	98"*	YES	Phifer	7
Sheerweave 2703	3%	YES	98" *	YES	Phifer	7
Sheerweave 2705	5%	YES	98" *	YES	Phifer	6
Sheerweave 2710	10%	YES	98"	YES	Phifer	6
Sheerweave 3000	14%	YES	96"	NO	Phifer	5
Sheerweave 4000	5%	YES	98" *	YES	Phifer	6
Sheerweave 4100	10%	YES	98"	YES	Phifer	6
Sheerweave 4400	3%	YES	98" *	YES	Phifer	7
Sheerweave 4500	5%	YES	98"	YES	Phifer	7
Sheerweave 4550	5%	YES	98"	YES	Phifer	7
Sheerweave 4600	3%	YES	98"	YES	Phifer	7
Sheerweave 4650	3%	YES	98"	YES	Phifer	7
Sheerweave 4800	1%	YES	96"	YES	Phifer	7
Sheerweave 4901	1%	YES	98"	YES	Phifer	7
Sheerweave 4903	3%	YES	98"	YES	Phifer	7
Sheerweave 5000	Varies	YES	98"	NO	Phifer	7
Sheerweave 7000	Blackout	YES	94" *	YES	Phifer	9
Sheerweave 7100	Blackout	YES	96"	YES	Phifer	7
Sheerweave 7500	Blackout	YES	98" *	YES	Phifer	6
Sheerweave Basic 3%	3%	YES	98"	YES	Phifer	6
Sheerweave Basic 5%	5%	YES	98"	YES	Phifer	5
Sheerweave Infinity 2 3%	3%	YES	98"	YES	Phifer	8
Sheerweave Infinity 2 5%	5%	YES	98"	YES	Phifer	8
Sheerweave Performance Plus 2390	5%	NO	94"	YES	Phifer	9
Sheerweave Performance Plus 2410	3%	NO	94"	YES	Phifer	9
Sheerweave Performance Plus 2500	1%	NO	94"	YES	Phifer	10
Shot Silk	Blackout	NO	78"	NO	Solaré (New 2018 Book)	9
Shantung	10%	YES	118"	YES	Solaré (New 2018 Book)	3
Silk Bamboo Blackout	Blackout	YES	102"	YES	Solaré (New 2018 Book)	3
Singular	Blackout	YES	110"	NO	Vertilux	5
Solaré 1%	1%	YES	118"	YES	Solaré	3
Solaré 10%	10%	YES	118"	YES	Solaré	2
Solaré 3%	3%	YES	118"	YES	Solaré	3
Solaré 5%	5%	YES	118"	YES	Solaré	2
Solar Screen 4000	5%	YES	118"	NO	Vertilux	3
Solaré GT	1%, 3%, 5%	YES	118"	YES	Solaré	6
Solaré Screen Plus 1%	1%	YES	118"	YES	Solaré (New 2018 Book)	3
Solaré Screen Plus 3%	3%	YES	118"	YES	Solaré (New 2018 Book)	2
Solaré Screen Plus 5%	5%	YES	118"	YES	Solaré (New 2018 Book)	1
Solaré GT (Sunset Blackout)	Blackout	NO	118"	YES	Solaré	6
Solaré GT Blackout Vinyl	Blackout	YES	118"	YES	Solaré	5
South Beach	Blackout	NO	98"	YES	Vertilux	4
South Beach Duplex	Blackout	NO	110"	YES	Vertilux	4
Strata SPC®	Translucent	YES	81"	NO	Solaré (New 2018 Book)	9
Sunset Blackout	Blackout	NO	118"	YES	Solaré (New 2018 Book)	1
Tenley	Translucent	NO	98"	NO	Solaré	1
Tenley Blackout	Blackout	NO	98"	NO	Solaré	2
Tinsel	Translucent	NO	106"	NO	Solaré	4
Topaz	Blackout	NO	82"	NO	Solaré (New 2018 Book)	7
Tuscany II	Translucent	NO	110"	YES	Wilson	5
Tuscany II	Blackout	NO	110"	YES	Wilson	7
Venice	Blackout	NO	110"	NO	Solaré	4
Vision 314	14%	YES	98"	NO	Vertilux	5
Vision 320	20%	YES	98"	NO	Vertilux	2
Vision 350	10%	YES	98"	YES	Vertilux	5
Vision 350 Styles (10%)	10%	YES	63"	NO	Vertilux	8
Vision 351 Comfort Plus	1%	YES	98"	YES	Vertilux	5
Vision 403	3%	YES	98"	YES	Vertilux	5
Vision 550	5%	YES	118"	YES	Vertilux	5
Vision 597	7%	YES	98"	NO	Vertilux	6
Vision 650	3%	YES	98"	YES	Vertilux	6
Vision Calico 550	5%	YES	98"	NO	Vertilux	6
Vision Colorama 365	5%	YES	98"	YES	Vertilux	5

* PLEASE NOTE: FABRIC MAY COME IN WIDER WIDTHS. HOWEVER, THESE WIDER WIDTHS ARE NOT REGULARLY STOCKED. CONTACT TEXTON CUSTOMER SERVICE FOR ASSISTANCE.

MATERIAL COLLECTION

FABRIC DESCRIPTION	OPENNESS	FR RATED	WIDTH	RAILROAD	SAMPLED IN	PG
Vision Crystal 550	5%	Yes	98"	Yes	Vertilux	6
WHISPER	TRANSLUCENT	No	80"	No	SOLARÉ (NEW 2018 BOOK)	3
WOODLAND	TRANSLUCENT	No	78"	No	SOLARÉ (NEW 2018 BOOK)	4
ZADIE	TRANSLUCENT	No	80"	No	SOLARÉ (NEW 2018 BOOK)	6
ZETA	TRANSLUCENT	No	80"	No	SOLARÉ (NEW 2018 BOOK)	5
Vision Designer Collection	5%	Yes	98"	Yes	Vertilux	6
Voile	Sheer	Yes	80"	Yes	Solaré (New 2018 Book)	4

NEOLUX TRANSITIONAL SHADE MATERIAL COLLECTION

MATERIALS ARE SAMPLED IN THE NEOLUX SAMPLE BOOK.

FABRIC DESCRIPTION	OPENNESS	FR RATED	WIDTH	SAMPLED IN	PG
ARCADIA	TRANSLUSCENT	No	108"	NEOLUX BOOK	1
CAICOS	TRANSLUSCENT	No	108"	NEOLUX BOOK	1
CANCUN	TRANSLUSCENT	No	108"	NEOLUX BOOK	1
CLASSIC DIM OUT	ROOM DARKENING	No	102"	NEOLUX BOOK	2
COMFORT DIM OUT	ROOM DARKENING	No	102"	NEOLUX BOOK	1
CRYSTAL	TRANSLUSCENT	No	108"	NEOLUX BOOK	1
FIJI	TRANSLUSCENT	No	102"	NEOLUX BOOK	1
GLAMOUR	TRANSLUSCENT	No	108"	NEOLUX BOOK	2
HORIZON	TRANSLUSCENT	No	108"	NEOLUX BOOK	1
LINEN	TRANSLUSCENT	No	108"	NEOLUX BOOK	1
LUXURY	TRANSLUSCENT	No	108"	NEOLUX BOOK	1
MADEIRA	TRANSLUSCENT	No	108"	NEOLUX BOOK	2
MYKONOS DIM OUT	ROOM DARKENING	No	108"	NEOLUX BOOK	2
NAPA	TRANSLUSCENT	No	108"	NEOLUX BOOK	2
ROYAL	TRANSLUSCENT	No	108"	NEOLUX BOOK	2
RUSTIC DIM OUT	ROOM DARKENING	No	106"	NEOLUX BOOK	2
SERENADE	TRANSLUSCENT	No	108"	NEOLUX BOOK	1
SHEER VISION	TRANSLUSCENT	No	98"	NEOLUX BOOK	2
SOFT	TRANSLUSCENT	No	108"	NEOLUX BOOK	1
SPLENDOR	TRANSLUSCENT	No	108"	NEOLUX BOOK	2

VISION TRANSITIONAL SHADE MATERIAL COLLECTION

FABRIC DESCRIPTION	OPENNESS	FR RATED	WIDTH	SAMPLED IN	PG
AMALFI	TRANSLUCENT	No	108"	VISION SHADE BOOK	4
CAPRI	TRANSLUCENT	No	108"	VISION SHADE BOOK	1
CAPRI BLACK	TRANSLUCENT	No	108"	VISION SHADE BOOK	2
CAPRI COLOUR	TRANSLUCENT	No	108"	VISION SHADE BOOK	2
FLORENCE	TRANSLUCENT	No	108"	VISION SHADE BOOK	3
MILAN	TRANSLUCENT	No	108"	VISION SHADE BOOK	4
NAPLES	ROOM DARKENING	No	108"	VISION SHADE BOOK	5
ROMA	ROOM DARKENING	No	108"	VISION SHADE BOOK	5
SICILY	TRANSLUCENT	No	108"	VISION SHADE BOOK	4
SIENA FR	ROOM DARKENING	Yes	108"	VISION SHADE BOOK	5
SORRENTO	TRANSLUCENT	No	108"	VISION SHADE BOOK	4
TUSCANY	TRANSLUCENT	No	108"	VISION SHADE BOOK	4
VENICE	TRANSLUCENT	No	108"	VISION SHADE BOOK	3
VERONA	TRANSLUCENT	No	108"	VISION SHADE BOOK	3

VISAGE SHADINGS MATERIAL COLLECTION

DESCRIPTION	OPENNESS	FR RATED	WIDTH	SAMPLED IN	PG
KNIGHTSBRIDGE (2" LOUVER)	TRANSLUCENT	No	102"	VISION SHADE BOOK	1
KENSINGTON (2" LOUVER)	TRANSLUCENT	No	102"	VISION SHADE BOOK	2
PIMLICO (2" LOUVER)	TRANSLUCENT	No	102"	VISION SHADE BOOK	3
MAYFAIR (1" LOUVER)	TRANSLUCENT	No	102"	VISION SHADE BOOK	4

FEATURES & OPTIONS

PLAIN HEMS

WITH PLAIN HEMS, THE FABRIC WRAPPED BOTTOM RAIL IS THE BOTTOM OF THE SHADE. PLAIN HEMS ARE OFTEN THE PREFERRED WAY TO FINISH THE BOTTOM OF THE SHADE WHEN IT IS IMPORTANT TO MINIMIZE LIGHT LEAKAGE ON INSIDE MOUNTED APPLICATIONS. DECORATIVE HEMS, PARTICULARLY STYLES LIKE FLORENCE AND CHALET, CAN LEAVE LIGHT GAPS BETWEEN THE SILL AND THE TRIM EVEN WHEN THE SHADE IS IN THE FULLY LOWERED POSITION.

DECORATIVE SCALLOPS

IN ADDITION TO PLAIN HEMS (FIG. 4A), THERE ARE SEVERAL DECORATIVE SCALLOPS OFFERED TO ENHANCE THE APPEARANCE OF THE BOTTOM OF THE SHADE. THESE DECORATIVE STYLES, ARE AVAILABLE FOR MANY FABRICS EXCLUDING SOLAR SCREEN MATERIAL. THE HEM STYLES EXTEND THE FABRIC BELOW THE BOTTOM ROD OF THE SHADE. MOST PATTERNS EXTEND ABOUT 6" BELOW THE RAIL. WHEN A DECORATIVE HEM IS USED WITH OUTSIDE MOUNTED SHADES, BE SURE TO ALLOW SUFFICIENT OVERLAP OF THE BOTTOM SILL TO PREVENT LIGHT GAPS. SEE PAGE 12.

TRIMS

DECORATIVE TRIMS ARE AVAILABLE TO ACCOMPANY A PLAIN OR DECORATIVE HEM OR SCALLOP. COLORS ARE AVAILABLE TO COORDINATE WITH THE WHOLE FABRIC COLLECTION. TRIMS AND SCALLOPS ARE SAMPLED IN THE 2018 SOLARÉ COLLECTION. IN ADDITION, THEY CAN BE FOUND ON PAGES 9-12.



STANDARD TRIM STYLE

SEE PAGE 9 & 10.



POLES & FINIALS

CERTAIN SCALLOP DESIGNS REQUIRE POLES AND FINIALS. FOR SELECTION, SEE THE POLES & FINIALS ON PAGE 11, OR THE 2018 SOLARÉ COLLECTION.



SEE PAGE 12 FOR PRICING.

DECORATIVE PULLS

FOR MORE DECORATIVE SHADES, CHOOSE A DECORATIVE PULL. SCALLOP PRICING AUTOMATICALLY INCLUDES A BARREL PULL. PULLS ARE MERELY DECORATIVE UNLESS INCORPORATING THE MAGIC TOUCH CORDLESS OPTION. TO UPGRADE, SEE THE TASSEL LIST ON PAGE 13, OR THE 2018 SOLARÉ COLLECTION. SEE PAGE 13 FOR PRICING.



CHAIN FINISHES

STAINLESS STEEL & PLASTIC (NOT SHOWN) ARE STANDARD AND COME WITH SHADE. ALL OTHER FINISHES BELOW—\$6 SUGGESTED RETAIL PER SHADE.



FABRIC ORIENTATION & RAILROADED FABRICS

THE FABRICS USED TO MAKE ROLLER SHADES ARE OF A LIMITED WIDTH (SEE COLLECTIONS CHART).

- ORDERED SHADES THAT ARE WITHIN THE MAXIMUM WIDTH OF THE FABRIC WILL BE MADE WITH THE FABRIC VERTICALLY ORIENTED.

STANDARD FABRIC ORIENTATION

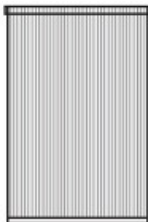

- ORDERED SHADES THAT ARE WIDER THAN THE MAXIMUM FABRIC WIDTH WILL BE MADE WITH THE FABRIC TURNED WIDTH FOR HEIGHT (HORIZONTALLY ORIENTED. THIS ONLY APPLIES TO FABRICS THAT CAN BE TURNED WIDTH FOR HEIGHT (RAILROADED).

FABRIC TURNED WIDTH FOR LENGTH



- ORDERED SHADES THAT ARE LARGER (BOTH WIDTH-WISE AND HEIGHT-WISE) THAN THE MAXIMUM FABRIC WIDTH WILL BE MADE WITH A VISIBLE SEAM. THIS ONLY APPLIES TO FABRICS THAT CAN BE TURNED WIDTH FOR HEIGHT (RAILROADED).

LARGE SHADE MAY HAVE VISIBLE SEAMS



PLEASE NOTE: VISIBLE SEAM LOCATIONS MAY VARY WHEN MATERIAL IS RAILROADED. TEXTON WILL PLACE THE SEAM AT THE HIGHEST POSSIBLE LOCATION ON THE SHADE. CONTACT CUSTOMER SERVICE FOR MORE INFORMATION.

IF CUSTOMER REQUIRES A SEAM FOR SMALLER SHADE(S) IN ORDER TO MATCH A PARTICULAR SHADE REQUIRING A SEAM, THEN ADD 10% TO THE PRICE OF THE SMALLER SHADES.

FEATURES & OPTIONS (CONTINUED)

CASSETTE OPTION WITH OPTIONAL FABRIC INSERT

- A TRADITIONAL OPTION AVAILABLE WITH EVERY ROLLER SHADE.
- THE FABRIC OPTIONAL WRAPPED CASSETTE IS ROUNDED AND COVERS THE ROLLER AND BRACKETS FOR A CLEAN, COORDINATED LOOK.

AVAILABLE IN YOUR CHOICE OF:

- WHITE • BRONZE • BLACK
- VANILLA • CLEAR ANODIZED

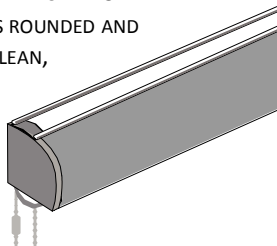

- IF YOU HAVE A CLUTCH COLOR PREFERENCE, PLEASE SPECIFY ON ORDER, OTHERWISE YOUR FABRICATOR WILL CHOOSE BASED ON YOUR FABRIC DECISION.
- SOME FABRICS ARE NOT AVAILABLE AS A FABRIC INSERT. PLEASE CONTACT YOUR FABRICATOR FOR DETAILS.

SEE PRICE GRIDS.

MAGIC TOUCH CORDLESS

CORDLESS IS AN OPTION WHICH RAISES AND LOWERS THE SHADE THE SAME AS THE CLUTCH ASSIST BUT USES NO CHAIN CONTROL. A GREAT OPTION FOR CHILDREN'S ROOMS OR ANY ROOM WITH CHILD OR PET TRAFFIC. SIZE LIMITATIONS APPLY.



SEE PRICE GRIDS.
AVAILABLE WITH CASSETTE.

NEOLUX & VISION TRANSITIONAL SHADES

NEOLUX & VISION TRANSITIONAL SHADES ARE A CONTEMPORARY, TRENDY WINDOW COVERING SOLUTION THAT HAS GROWN FAST DURING RECENT YEARS, NOT ONLY IN EUROPEAN AND LATIN AMERICAN COUNTRIES, BUT ALSO IN THE UNITED STATES.

NEOLUX TRANSITIONAL SHADE COLLECTION BY TEXTON, INCLUDES 23 DIFFERENT PATTERNS WITH A WIDE RANGE OF COLORS TO CHOOSE FROM.



THESE FABRIC COLLECTIONS FEATURE NATURAL LOOKING PATTERNS, DECORATIVE METALLIC, DECORATIVE PLAIN, FULL BODIED, TEXTURIZED FABRICS, VINYL FABRICS AND THREE DIM OUT (ROOM DARKENING) FABRICS WHEN EXTRA PRIVACY IS DESIRED.

THIS EMBELLISHING COLLECTION IS SPECIALLY SUITED FOR DUAL SHADE APPLICATIONS, PROVIDING YOU WITH AN EXTRAORDINARILY EFFICIENT LIGHT MANAGEMENT SYSTEM, WHICH FILTERS AND SOFTENS DAYLIGHT WHILE AT THE SAME TIME OFFERING MORE CONTROL OF YOUR PRIVACY. SEE NEOLUX PRICE GRIDS ON PAGES 34 & 35, AND SEE VISION PRICE GRIDS ON PAGES 36-40.

FASCIA OPTIONS

- CONTEMPORARY OPTION AVAILABLE WITH EVERY ROLLER SHADE.
 - THE SQUARE ALUMINUM FASCIA COVERS THE ROLLER AND BRACKETS FOR A CLEAN, SOPHISTICATED LOOK.
 - AVAILABLE IN YOUR CHOICE OF:
 - WHITE
 - BRONZE
 - CLEAR ANODIZED
 - VANILLA (4" FASCIA ONLY)
 - BLACK (4" FASCIA ONLY)
 - 4 & 5" SIZES AVAILABLE.
 - 5" FASCIA CAN BE USED FOR LARGER SHADES AND FOR TWO SHADES IN ONE WINDOW OPENING (DUAL SHADE).
 - IF YOU HAVE A CLUTCH COLOR PREFERENCE, PLEASE SPECIFY ON ORDER, OTHERWISE YOUR FABRICATOR WILL CHOOSE BASED ON YOUR FABRIC DECISION.
- SEE PRICE GRIDS.

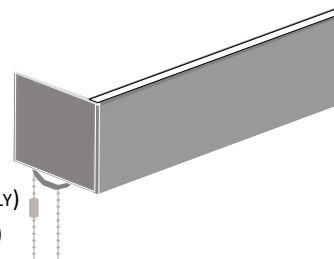

5" CLASSIC VALANCE (NEW)

5" CLASSIC VALANCES ARE AVAILABLE WITH A SHADE OR MAY ALSO BE A SEPARATE BOARD MOUNTED TOP TREATMENT. STANDARD SPECIFICATIONS:

- FABRIC WRAPPED WOOD HEADRAIL- 2 3/4" DEPTH X 3/4" HEIGHT. LARGER DEPTHS OF 3 1/2", 5 1/2", 7 1/4" OR 9 1/4" ARE ALSO AVAILABLE FOR A SURCHARGE.
- HEIGHT- 5" (INCLUDING HEADRAIL). CUSTOM HEIGHTS UP TO 10" ARE AVAILABLE FOR AN ADDITIONAL CHARGE. CONTACT TEXTON CUSTOMER SERVICE.

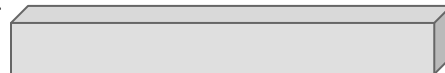

SIZE LIMITATIONS:

- MINIMUM WIDTH- 10"
- MAXIMUM WIDTH- MAXIMUM WIDTHS VARY BY FABRIC

MEASURING NOTES

- TEXTON WILL DEDUCT 1/8" FROM THE WIDTH FOR AN INSIDE MOUNT (IB).
- A CLASSIC VALANCE ORDERED WITH AN OUTSIDE MOUNT SHADE WILL BE MADE 1" WIDER THAN THE SHADE TO ALLOW SPACE FOR THE BRACKETS.
- OUTSIDE MOUNTED CLASSIC VALANCES ORDERED SEPARATELY WILL BE MADE THE EXACT WIDTH ORDERED.

VALANCE RETURNS

- VALANCE RETURNS ARE STANDARD ON OUTSIDE MOUNT VALANCES AND ARE ONLY SUPPLIED UPON REQUEST FOR INSIDE MOUNT VALANCES.

INSTALLATION BRACKETS

- "L" BRACKETS ARE AUTOMATICALLY INCLUDED WITH ALL OM VALANCES.
- 2" SCREWS ARE AUTOMATICALLY INCLUDED WITH ALL IM VALANCES.

TRIMS

THESE TRIMS ARE SAMPLED IN THE 2018 SOLARÉ SHADE COLLECTION. TRIM AND FURTHER ACCESSORIES ARE AVAILABLE IN ALL SOLARE SHADE COLLECTIONS.



CRYSTAL SNOWDROP **TPG-4**



CRYSTAL DEWDROP **TPG-4**



CRYSTAL BLACK **TPG-4**



GLITZ BLACK **TPG-5**



STROBE CALICO **TPG-1**



VOGUE IVORY **TPG-1**



CABLE ICE WHITE **TPG-1**



MELODY WHITE **TPG-1**



CABLE ANGORA **TPG-1**



ANTIQUE WHITE **TPG-1**



VOGUE NATURAL **TPG-1**



ANTIQUE IVORY **TPG-1**



VOGUE PLATINUM **TPG-1**



ANTIQUE ECRU **TPG-1**



CABLE FLEECE **TPG-1** [®]



METALLIC SILVER **TPG-2**



STROBE HESSIAN **TPG-1**



CABLE FUDGE **TPG-1**



VOGUE STEEL **TPG-1**



STROBE LINEN **TPG-1**



METALLIC GOLD **TPG-2**



MELODY BLACK **TPG-1**



TRIO CAMEL **TPG-1**



CABLE BERRY **TPG-1**



VOGUE ROYAL **TPG-1**



CABLE TAUPE **TPG-1**



MELODY PURPLE **TPG-1**



MELODY TURQUOISE **TPG-1**



ANTIQUE BEIGE **TPG-1**



MELODY FUCHSIA **TPG-1**



CABLE ICE WATERGREEN **TPG-1**

POLES & FINIALS

THESE POLES & FINIALS ARE SAMPLED IN THE SOLARÉ SHADE COLLECTION. POLES, FINIALS, AND FURTHER ACCESSORIES ARE AVAILABLE IN ALL SOLARÉ SHADE COLLECTIONS.

ALL WOOD POLES & BLACK METAL POLE ARE IN "POLE PRICE GROUP 1" (PPG1). BRASS AND CHROME METAL POLES ARE IN "POLE PRICE GROUP 2" (PPG2). BRUSHED STEEL-- PPG3.

SEE FINIALS BELOW FOR APPROPRIATE FINIAL PRICE GROUP (FPG) SEE PAGE 12 FOR POLE & FINIAL PRICING.



ACORN WALNUT

FPG 1



ACORN BEECH

FPG 1



ACORN WHITE

FPG 1

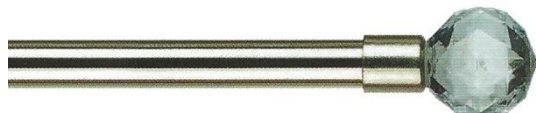

CRYSTAL BRASS

FPG 3



CRYSTAL SILVER

FPG 3



CRYSTAL BLACK

FPG 3



TWIST BRASS

FPG 3

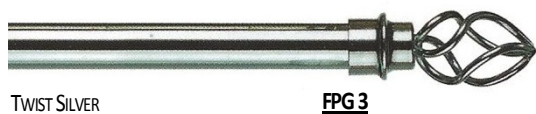

TWIST SILVER

FPG 3



TWIST BLACK

FPG 3

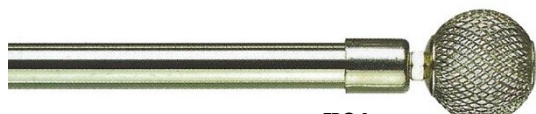

FILIGREE BRASS

FPG 4

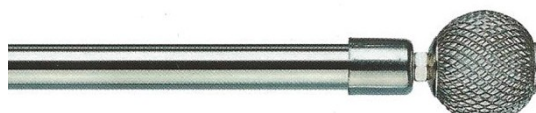

FILIGREE SILVER

FPG 4



FILIGREE BLACK

FPG 5



FPG 2

BALL WALNUT



FPG 2

BALL BEECH



FPG 2

BALL WHITE



FPG 5

TUBULAR WALNUT



FPG 5

TUBULAR BEECH



FPG 5

TUBULAR WHITE



FPG 5

TUBULAR BLACK



FPG 5

TUBULAR BRUSHED STEEL



FPG 4

BALL BRUSHED STEEL



FPG 4

CYLINDER BRUSHED STEEL



FPG 5

ACRYLIC BALL BRUSHED STEEL



FPG 5

GLITZ BRUSHED STEEL



FPG 5

GLITZ BLACK

SCALLOPS

THESE SCALLOPS ARE SAMPLED IN THE SOLARÉ SHADE COLLECTION. SCALLOPS AND FURTHER ACCESSORIES ARE AVAILABLE IN ALL SOLARÉ SHADE COLLECTIONS.



CLASSIC



RITZ



PROVENCE



COLONIAL



CORONET



PARAPET



TEMPLE



CASTILLE



COLONNADE



ARCH



APEX



QUAD

SCALLOP, POLE, & PULL PRICING

TRIM PRICE GROUPS

	24"	36"	48"	60"	72"	84"	96"
TPG 1	29	22	25	28	31	34	37
TPG 2	33	43	53	63	73	83	93
TPG 3	43	57	72	86	101	115	130
TPG 4	68	96	124	151	179	206	234
TPG 5	84	119	154	189	224	259	294

POLE PRICE GROUPS

	24"	36"	48"	60"	72"	84"	96"
PPG 1	20	26	31	37	43	48	54
PPG 2	26	49	57	66	75	84	93
PPG 3	33	45	57	70	82	94	106

Finial Price Groups

FPG 1	28
FPG 2	40
FPG 3	63
FPG 4	71
FPG 5	103

SCALLOP PRICE GROUPS ARE BASED ON TRIM SELECTED. SEE TRIM ON PAGES 9 & 10 FOR APPROPRIATE PRICE GROUP. FOR COM TRIM, USE TPG1 (TRIM PRICE GROUP 1).

SOME WIDER TRIMS MAY NOT BE ABLE TO BE APPLIED FOR CERTAIN SCALLOPS. CONTACT TEXTON FOR ANY QUESTIONS.

SCALLOP PRICING DOES NOT INCLUDE POLES AND FINIALS. IF YOUR SCALLOP REQUIRES POLES AND FINIALS, YOU MUST ADD THE APPROPRIATE PRICING .

DECORATIVE PULLS

PREMIER COLLECTION



PREMIER COLLECTION



CLASSIC COLLECTION

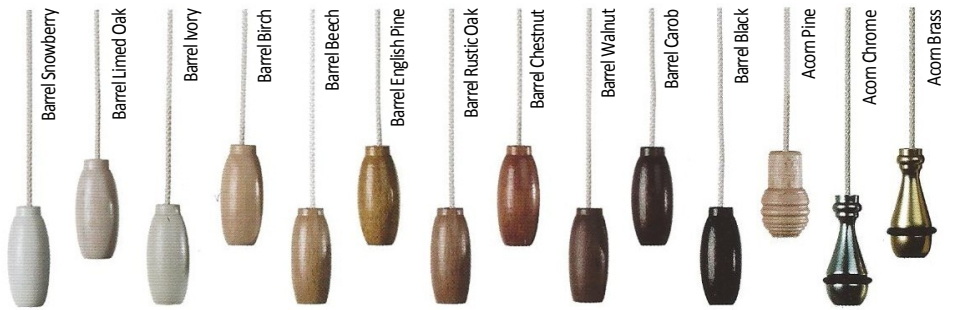

These Pulls are sampled in The 2018 SOLARÉ COLLECTION. Pulls and further accessories are available in all Solare Shade Collections.

PULL PRICING

Acorn Pine	Barrel All Colors	Acorns Chrome	Cylinder	Ball	Acorns Brass	3 Bead	Pear	Perspex Clear	Perspex Black	Marble	Crystal	Pom Pom	Cylinder	Tassel	Crystal Ball
3	5	33	33	34	36	38	50	51	54	56	67	78	95	55	142

ALL SCALLOP PRICING ON PAGE 12, INCLUDES A CLASSIC BARREL TASSEL.

HOW TO ORDER SCALLOPS, TRIMS, & ACCESSORIES

IN ORDER TO PURCHASE SPECIALTY OPTIONS, SUCH AS SCALLOPS, ALONG WITH TRIMS, DECORATIVE POLES, AND PULLS, YOU MUST ADD THE FOLLOWING ITEMS TOGETHER:

THE PRICE OF THE SHADE LOCATED ON PAGES 14-33, INCLUDING ANY OTHER CHARGES SUCH AS MOTORIZATION, OR OTHER CONTROL OPTIONS LOCATED ON THOSE PAGES.

THE DECORATIVE TRIM LOCATED ON PAGES 9 & 10.

IF YOUR SCALLOP REQUIRE A DECORATIVE POLE, YOU WILL NEED TO ADD THE POLE PRICING ON PAGE 12. SEE POLES ON PAGE 11 FOR THEIR RESPECTIVE PRICE GROUPS.

POLES WILL REQUIRE FINIALS, SEE FINIAL PRICING ON PAGE 12. IN ADDITION, FINIALS, ALONG WITH THEIR RESPECTIVE PRICE GROUPS, ARE LOCATED ON PAGE 12.

SELECT DECORATIVE PULL ABOVE ON THIS PAGE ALONG WITH PULL PRICING, ALSO ABOVE. SCALLOP PRICING INCLUDES A BARREL PULL AUTOMATICALLY.

EXAMPLE: SHADE- 36" X 72"

MATERIAL	OPTION 1	TRIM	SCALLOP	PULL	TOTAL
BROOME II (PG -5)	MAGIC TOUCH CORDLESS	VOGUE IVORY (TPG 1)	COLONIAL	BARREL	SUGGESTED RETAIL
228	+	85	+	0 (INCLUDED)	= 308

PG-1

CLASSIC TIMELESS, GUARDIAN, NORDICSCREEN PLUS BW 10%, Solaré Screen Plus 5%, SUNSET BLACKOUT, TENLEY (TRANSLUCENT)

MOTORS AND INTERNAL LITHIUM ION BATTERY INCLUDED IN SUGGESTED PRICING.

Volta™ QUIET BATTERY & NON BATTERY LOW VOLTAGE SHADES*

	24"	30"	36"	42"	48"	54"	60"	66"	72"	78"	84"	90"	96"	108"	120"	132"	144"	156"	168"	SIDE CHANNEL	
SEE PAGES 3-6 FOR MATERIAL SIZE LIMITATIONS & PAGE 46 FOR PRODUCT SIZE LIMITATIONS.	36"	538	545	551	558	565	571	578	585	591	611	613	616	766	785	803	978	1,003	1,029	1,054	53
	48"	542	550	558	566	573	581	589	597	605	629	631	633	786	807	828	1,011	1,039	1,068	1,350	71
	60"	547	556	564	573	582	591	600	609	618	646	649	787	806	830	983	1,044	1,075	1,108	1,399	88
	72"	551	561	571	581	591	601	611	621	631	664	801	805	826	852	1,008	1,080	1,121	1,163	1,459	106
	84"	555	567	578	589	600	611	622	633	644	682	818	823	846	873	1,040	1,126	1,172	1,458	1,518	124
	96"	560	572	584	596	609	621	633	645	657	699	836	840	865	906	1,078	1,173	1,223	1,513	1,578	141
	108"	564	578	591	604	617	631	644	657	671	849	852	861	895	1,065	1,115	1,220	1,259	1,568	1,637	159
	120"	569	583	597	612	626	641	657	672	686	867	877	888	925	1,099	1,153	1,252	1,550	1,623	1,697	176
	132"	573	589	606	622	637	653	668	684	828	892	903	915	1,024	1,133	1,175	1,298	1,601	1,679	1,756	194
	144"	580	596	613	629	646	663	679	823	849	918	930	1,009	1,054	1,152	1,213	1,345	1,652	1,734	1,816	212
	156"	584	602	619	637	655	673	814	842	870	944	1,021	1,036	1,084	1,186	1,250	1,392	1,703	1,789	1,875	229
	168"	588	607	626	645	664	682	831	861	890	1,032	1,048	1,063	1,152	1,220	1,288	1,439	1,754	1,844	1,935	247
SILL CHANNEL		18	22	27	31	36	40	44	49	53	58	62	66	71	80	88	97	106	115	124	

VOLTA BATTERY CHARGER - 42 *PLEASE NOTE- EACH VOLTA NON BATTERY LOW VOLTAGE SHADE INCLUDES 110V. TRANSFORMER POWER SUPPLY.

Volta™ MOTORIZATION CONTROLS

						
1 CHANNEL REMOTE \$104	15 CHANNEL REMOTE \$122	5 CHANNEL WALL SWITCH* \$94	1 CHANNEL WALL SWITCH \$80	2 CHANNEL WALL SWITCH \$90	15 CHANNEL WALL SWITCH \$98	SUN SENSOR \$66

ALL WALL SWITCHES INCLUDE A DECO-STYLE PLATE

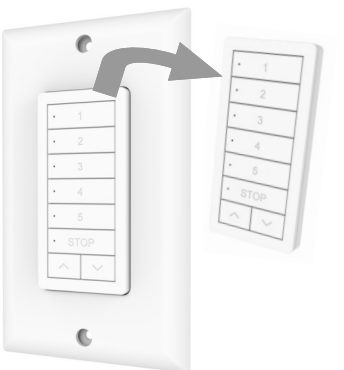

* THE 5 CHANNEL WALL SWITCH IS SURFACE MOUNTED. NO CUT-OUT REQUIRED. IN ADDITION, CONTROL DETACHES & SERVES AS HANDHELD REMOTE.



SOLAR PANEL ACCESSORY
\$130



ARC REPEATER FOR VOLTA
\$156

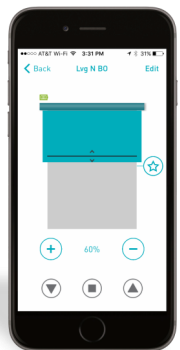

APP CONTROL ACCESSORY WITH WI-FI TO 433 - 2 WAY RF BRIDGE
\$372

OVERSIZED FREIGHT: ANY PRODUCT OVER 90" WIDE IS SUBJECT TO AN OVERSIZED SURCHARGE. SHIPMENTS WITHIN TRADING AREA WILL BE CHARGED \$95 & OUTSIDE TRADING AREA \$125. TRADING AREA INCLUDES TX, LA, NM, OK, MS, TN, AR. SHIPMENTS OVER 12' WILL BE CHARGED AN ADDITIONAL \$100, OVER 15'. ADDITIONAL SURCHARGES MAY APPLY FOR RESIDENTIAL SHIP LOCATIONS. SEE TEXTON FREIGHT POLICIES AT WWW.TEXTON.COM/FREIGHT_POLICY.

PG-2

Allure (Blackout), BIMINI (TRANSLUCENT), Bromus 5%, CLASSIC SCREEN 5%, NORDICSCREEN PLUS BW 1%, NORDICSCREEN PLUS BW 3%, NORDICSCREEN PLUS BW 5%, NORDICSCREEN PLUS TWILL 1%, NORDICSCREEN PLUS, TWILL 3%, SOLARÉ 10%, SOLARÉ 5%, Solaré Screen Plus 3%, TENLEY (BLACKOUT), VISION 320

Volta™ QUIET BATTERY & NON BATTERY LOW VOLTAGE SHADES*

MOTORS AND INTERNAL LITHIUM ION BATTERY INCLUDED IN SUGGESTED PRICING.

	24"	30"	36"	42"	48"	54"	60"	66"	72"	78"	84"	90"	96"	108"	120"	132"	144"	156"	168"	SIDE CHANNEL	
SEE PAGES 3-6 FOR MATERIAL SIZE LIMITATIONS & PAGE 46 FOR PRODUCT SIZE LIMITATIONS.	36"	540	547	555	562	569	577	584	591	598	621	623	625	777	797	817	996	1,023	1,050	1,077	53
	48"	545	554	562	571	579	588	596	605	613	641	643	645	800	822	845	1,033	1,063	1,094	1,378	71
	60"	550	560	570	579	589	599	609	619	628	660	663	802	822	848	1,003	1,070	1,104	1,139	1,433	88
	72"	555	566	577	588	599	610	621	632	643	680	817	822	845	873	1,031	1,110	1,155	1,200	1,498	106
	84"	560	572	585	597	609	621	634	646	658	700	837	841	868	897	1,067	1,161	1,211	1,499	1,563	124
	96"	565	579	592	606	619	633	646	660	673	720	857	861	889	933	1,108	1,213	1,267	1,560	1,628	141
	108"	570	585	600	614	629	644	659	673	688	873	876	884	921	1,095	1,148	1,264	1,307	1,620	1,693	159
	120"	575	591	607	623	639	655	673	689	705	892	903	914	954	1,132	1,189	1,300	1,603	1,681	1,758	176
	132"	580	597	617	634	651	669	686	703	849	920	932	943	1,056	1,169	1,215	1,351	1,659	1,741	1,824	194
	144"	587	606	624	643	661	680	698	844	872	949	960	1,040	1,089	1,191	1,256	1,402	1,714	1,801	1,889	212
	156"	592	612	632	652	671	691	835	865	894	977	1,054	1,069	1,122	1,228	1,297	1,453	1,770	1,862	1,954	229
	168"	597	618	639	660	681	702	853	885	917	1,068	1,083	1,098	1,192	1,265	1,338	1,505	1,826	1,922	2,019	247
SILL CHANNEL		18	22	27	31	36	40	44	49	53	58	62	66	71	80	88	97	106	115	124	

VOLTA BATTERY CHARGER - 42 *PLEASE NOTE- EACH VOLTA NON BATTERY LOW VOLTAGE SHADE INCLUDES 110V. TRANSFORMER POWER SUPPLY.

Volta™ MOTORIZATION CONTROLS

						
1 CHANNEL REMOTE \$104	15 CHANNEL REMOTE \$122	5 CHANNEL WALL SWITCH* \$94	1 CHANNEL WALL SWITCH \$80	2 CHANNEL WALL SWITCH \$90	15 CHANNEL WALL SWITCH \$98	SUN SENSOR \$66

ALL WALL SWITCHES INCLUDE A DECO-STYLE PLATE

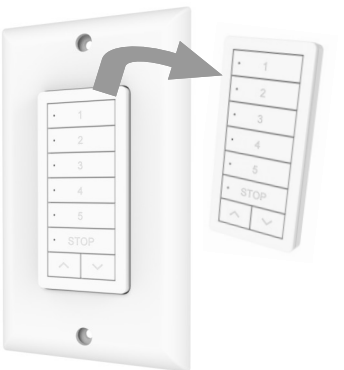

* THE 5 CHANNEL WALL SWITCH IS SURFACE MOUNTED. NO CUT-OUT REQUIRED. IN ADDITION, CONTROL DETACHES & SERVES AS HANDHELD REMOTE.



SOLAR PANEL ACCESSORY
\$130



ARC REPEATER FOR VOLTA
\$156

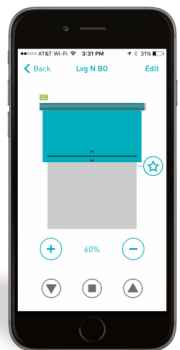

APP CONTROL ACCESSORY WITH WI-FI TO 433 - 2 WAY RF BRIDGE
\$372

OVERSIZED FREIGHT: ANY PRODUCT OVER 90" WIDE IS SUBJECT TO AN OVERSIZED SURCHARGE. SHIPMENTS WITHIN TRADING AREA WILL BE CHARGED \$95 & OUTSIDE TRADING AREA \$125. TRADING AREA INCLUDES TX, LA, NM, OK, MS, TN, AR. SHIPMENTS OVER 12' WILL BE CHARGED AN ADDITIONAL \$100, OVER 15'. ADDITIONAL SURCHARGES MAY APPLY FOR RESIDENTIAL SHIP LOCATIONS. SEE TEXTON FREIGHT POLICIES AT WWW.TEXTON.COM/FREIGHT_POLICY.

PG-3

3000 CA 3%, 3000 HT 3%, 3000 HT 5%, 3000 NET 1%, 3000 NET 10%, 3000 NET 3%, 3000 NET 5%, 3000 RR 3%, 3000 SS 3%, 4000 L,W 5%, 4000 NET 10%, 4000 NET 3%, 4000 NET 5%, 4700 P,Q <1%, AURA, BIMINI (BLACKOUT), CLASSIC SCREEN 3%, DAPPLE SPC, MATTIZ FR, OSLO (TRANSLUCENT), PERSIS 8%, REGAL, SCALA, SHANTUNG 10%, SILK BAMBOO (BLACKOUT), SOLARÉ 1%, SOLARÉ 3%, SOLAR SCREEN 4000, SOLARÉ SCREEN PLUS 1%, WHISPER

MOTORS AND INTERNAL LITHIUM ION BATTERY INCLUDED IN SUGGESTED PRICING.

Volta™ QUIET BATTERY & NON BATTERY LOW VOLTAGE SHADES*

	24"	30"	36"	42"	48"	54"	60"	66"	72"	78"	84"	90"	96"	108"	120"	132"	144"	156"	168"	SIDE CHANNEL	
SEE PAGES 3-6 FOR MATERIAL SIZE LIMITATIONS & PAGE 46 FOR PRODUCT SIZE LIMITATIONS.	36"	545	554	562	571	580	588	597	605	614	641	644	646	800	823	846	1,034	1,065	1,096	1,126	53
	48"	552	562	572	582	592	602	612	623	633	666	669	671	829	855	882	1,082	1,116	1,151	1,440	71
	60"	558	570	581	593	605	616	628	640	652	692	694	833	857	887	1,047	1,129	1,168	1,208	1,507	88
	72"	564	577	591	604	617	631	644	657	670	717	853	858	886	920	1,082	1,178	1,229	1,280	1,584	106
	84"	570	585	600	615	630	645	660	674	689	742	879	883	915	950	1,126	1,239	1,296	1,591	1,662	124
	96"	577	593	610	626	642	659	675	692	708	767	904	908	942	992	1,174	1,300	1,362	1,663	1,739	141
	108"	583	601	619	637	655	673	691	709	727	924	927	936	980	1,162	1,222	1,361	1,413	1,735	1,817	159
	120"	589	609	628	648	668	687	709	728	748	949	960	970	1,019	1,205	1,270	1,407	1,719	1,807	1,894	176
	132"	596	617	640	661	682	703	725	746	896	983	994	1,005	1,127	1,248	1,304	1,468	1,785	1,879	1,972	194
	144"	604	627	650	672	695	718	740	890	922	1,016	1,028	1,107	1,165	1,277	1,352	1,528	1,852	1,950	2,049	212
	156"	610	635	659	683	707	732	880	914	949	1,049	1,127	1,141	1,204	1,321	1,400	1,589	1,918	2,022	2,127	229
	168"	617	643	668	694	720	746	902	938	975	1,145	1,161	1,176	1,280	1,364	1,448	1,650	1,985	2,094	2,204	247
SILL CHANNEL	18	22	27	31	36	40	44	49	53	58	62	66	71	80	88	97	106	115	124		

VOLTA BATTERY CHARGER - 42 *PLEASE NOTE- EACH VOLTA NON BATTERY LOW VOLTAGE SHADE INCLUDES 110V. TRANSFORMER POWER SUPPLY.

Volta™ MOTORIZATION CONTROLS

						
1 CHANNEL REMOTE \$104	15 CHANNEL REMOTE \$122	5 CHANNEL WALL SWITCH* \$94	1 CHANNEL WALL SWITCH \$80	2 CHANNEL WALL SWITCH \$90	15 CHANNEL WALL SWITCH \$98	SUN SENSOR \$66

ALL WALL SWITCHES INCLUDE A DECO-STYLE PLATE

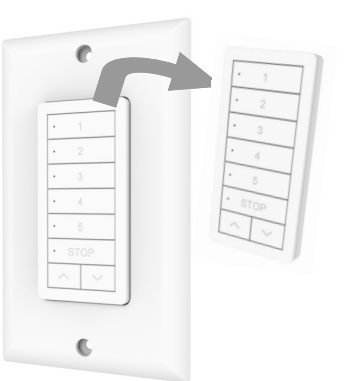

* THE 5 CHANNEL WALL SWITCH IS SURFACE MOUNTED. NO CUT-OUT REQUIRED. IN ADDITION, CONTROL DETACHES & SERVES AS HANDHELD REMOTE.



SOLAR PANEL ACCESSORY
\$130



ARC REPEATER FOR VOLTA
\$156

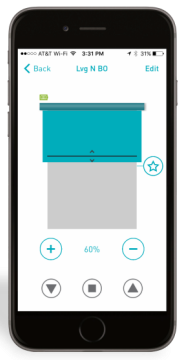

APP CONTROL ACCESSORY WITH WI-FI TO 433 - 2 WAY RF BRIDGE
\$372

OVERSIZED FREIGHT: ANY PRODUCT OVER 90" WIDE IS SUBJECT TO AN OVERSIZED SURCHARGE. SHIPMENTS WITHIN TRADING AREA WILL BE CHARGED \$95 & OUTSIDE TRADING AREA \$125. TRADING AREA INCLUDES TX, LA, NM, OK, MS, TN, AR. SHIPMENTS OVER 12' WILL BE CHARGED AN ADDITIONAL \$100, OVER 15'. ADDITIONAL SURCHARGES MAY APPLY FOR RESIDENTIAL SHIP LOCATIONS. SEE TEXTON FREIGHT POLICIES AT WWW.TEXTON.COM/FREIGHT_POLICY.

PG-4

BASIX (TRANSLUCENT), EFRON, HAVEN, KIANA, LINEN LIGHT, LINENWEAVE, MADRID SPC, MALACCA, MISTRAL, NORDICSCREEN PLUS BW 1%, ROME, SOUTH BEACH, SOUTH BEACH DUPLEX, TINSEL, VENICE, VOILE, WOODLAND

Volta™ QUIET BATTERY & NON BATTERY LOW VOLTAGE SHADES*

MOTORS AND INTERNAL LITHIUM ION BATTERY INCLUDED IN SUGGESTED PRICING.

	24"	30"	36"	42"	48"	54"	60"	66"	72"	78"	84"	90"	96"	108"	120"	132"	144"	156"	168"	SIDE CHANNEL	
SEE PAGES 3-6 FOR MATERIAL SIZE LIMITATIONS & PAGE 46 FOR PRODUCT SIZE LIMITATIONS.	36"	550	560	570	580	590	600	610	619	629	662	664	666	824	849	875	1,073	1,107	1,141	1,175	53
	48"	558	570	582	593	605	617	628	640	652	692	694	697	858	888	918	1,130	1,169	1,208	1,501	71
	60"	566	579	593	606	620	634	647	661	675	722	725	863	892	927	1,090	1,186	1,231	1,276	1,580	88
	72"	573	589	604	620	635	651	666	682	697	753	889	894	927	965	1,133	1,246	1,303	1,360	1,670	106
	84"	581	598	616	633	650	668	685	703	720	783	920	924	961	1,003	1,184	1,316	1,379	1,682	1,760	124
	96"	588	608	627	646	665	685	704	723	743	813	950	954	994	1,051	1,239	1,387	1,456	1,765	1,850	141
	108"	596	617	638	659	681	702	723	744	765	976	979	987	1,038	1,227	1,295	1,457	1,518	1,848	1,939	159
	120"	603	627	650	673	696	719	744	767	790	1,006	1,016	1,027	1,083	1,277	1,350	1,512	1,835	1,932	2,029	176
	132"	611	636	663	688	713	738	763	788	942	1,044	1,055	1,066	1,197	1,327	1,391	1,583	1,911	2,015	2,119	194
	144"	621	648	675	701	728	755	782	936	972	1,083	1,094	1,174	1,241	1,362	1,447	1,653	1,988	2,098	2,208	212
	156"	628	657	686	715	743	772	925	964	1,003	1,121	1,198	1,213	1,286	1,412	1,502	1,724	2,065	2,182	2,298	229
	168"	636	667	697	728	759	789	950	991	1,033	1,222	1,237	1,253	1,367	1,462	1,557	1,794	2,142	2,265	2,388	247
SILL CHANNEL	18	22	27	31	36	40	44	49	53	58	62	66	71	80	88	97	106	115	124		

VOLTA BATTERY CHARGER - 42 *PLEASE NOTE- EACH VOLTA NON BATTERY LOW VOLTAGE SHADE INCLUDES 110V. TRANSFORMER POWER SUPPLY.

Volta™ MOTORIZATION CONTROLS

						
1 CHANNEL REMOTE \$104	15 CHANNEL REMOTE \$122	5 CHANNEL WALL SWITCH* \$94	1 CHANNEL WALL SWITCH \$80	2 CHANNEL WALL SWITCH \$90	15 CHANNEL WALL SWITCH \$98	SUN SENSOR \$66

ALL WALL SWITCHES INCLUDE A DECO-STYLE PLATE

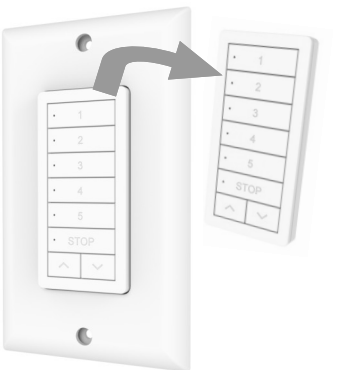

* THE 5 CHANNEL WALL SWITCH IS SURFACE MOUNTED. NO CUT-OUT REQUIRED. IN ADDITION, CONTROL DETACHES & SERVES AS HANDHELD REMOTE.



SOLAR PANEL ACCESSORY
\$130



ARC REPEATER FOR VOLTA
\$156

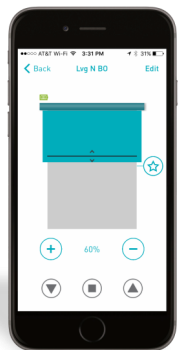

APP CONTROL ACCESSORY WITH WI-FI TO 433 - 2 WAY RF BRIDGE
\$372

OVERSIZED FREIGHT: ANY PRODUCT OVER 90" WIDE IS SUBJECT TO AN OVERSIZED SURCHARGE. SHIPMENTS WITHIN TRADING AREA WILL BE CHARGED \$95 & OUTSIDE TRADING AREA \$125. TRADING AREA INCLUDES TX, LA, NM, OK, MS, TN, AR. SHIPMENTS OVER 12' WILL BE CHARGED AN ADDITIONAL \$100, OVER 15'. ADDITIONAL SURCHARGES MAY APPLY FOR RESIDENTIAL SHIP LOCATIONS. SEE TEXTON FREIGHT POLICIES AT WWW.TEXTON.COM/FREIGHT_POLICY.

PG-5

BAMBOO, BOSTON II (TRANSLUCENT), BROOME II (TRANSLUCENT), COLOURTEX, CONCORD II (TRANSLUCENT), CONTEX SPC, CORAL, FLUTTER, HARMONY, IBIZA, IMAGINE, MERCURY II (TRANSLUCENT), MINERAL, SATIN, SCREEN 3000 BLACKOUT FR, SHEERWEAVE 3000, SHEERWEAVE BASIC 5%, SOLARÉ GT BLACKOUT VINYL*, SINGULAR FR, TUSCANY II (TRANSLUCENT), VISION 314, VISION 350, VISION 351 COMFORT PLUS, VISION 403, VISION 550, VISION COLORAMA 365, ZETA

* PLUS \$50 NET SURCHARGE PER ORDER.

MOTORS AND INTERNAL LITHIUM ION BATTERY INCLUDED IN SUGGESTED PRICING.

Volta™ QUIET BATTERY & NON BATTERY LOW VOLTAGE SHADES*

	24"	30"	36"	42"	48"	54"	60"	66"	72"	78"	84"	90"	96"	108"	120"	132"	144"	156"	168"	SIDE CHANNEL	
SEE PAGES 3-6 FOR MATERIAL SIZE LIMITATIONS & PAGE 46 FOR PRODUCT SIZE LIMITATIONS.	36"	623	626	628	630	633	635	637	639	649	688	690	692	853	883	912	1,122	1,160	1,199	1,237	53
	48"	627	630	632	630	633	635	649	663	676	725	727	729	895	930	964	1,191	1,235	1,280	1,578	71
	60"	631	634	636	630	640	656	672	688	704	761	764	902	937	977	1,146	1,260	1,311	1,363	1,674	88
	72"	635	638	640	640	658	676	695	713	732	798	935	939	979	1,024	1,198	1,331	1,396	1,461	1,779	106
	84"	639	642	644	656	676	697	718	738	759	835	972	976	1,020	1,069	1,258	1,414	1,486	1,797	1,884	124
	96"	643	646	648	672	695	718	741	764	787	872	1,008	1,013	1,061	1,126	1,323	1,496	1,576	1,895	1,989	141
	108"	647	650	663	688	713	738	764	789	814	1,041	1,044	1,052	1,112	1,310	1,387	1,579	1,651	1,993	2,095	159
	120"	651	654	676	704	732	759	789	817	844	1,077	1,088	1,099	1,164	1,369	1,452	1,647	1,981	2,090	2,200	176
	132"	655	658	693	722	752	782	812	842	1,001	1,122	1,133	1,145	1,286	1,427	1,502	1,730	2,071	2,188	2,305	194
	144"	659	674	706	738	771	803	835	994	1,036	1,167	1,179	1,258	1,338	1,471	1,567	1,812	2,162	2,286	2,410	212
	156"	663	686	720	755	789	823	982	1,026	1,071	1,212	1,290	1,304	1,389	1,529	1,632	1,895	2,252	2,384	2,516	229
	168"	667	697	734	771	807	844	1,011	1,059	1,106	1,320	1,335	1,351	1,478	1,587	1,696	1,978	2,342	2,481	2,621	247
SILL CHANNEL	18	22	27	31	36	40	44	49	53	58	62	66	71	80	88	97	106	115	124		

VOLTA BATTERY CHARGER - 42 *PLEASE NOTE- EACH VOLTA NON BATTERY LOW VOLTAGE SHADE INCLUDES 110V. TRANSFORMER POWER SUPPLY.

Volta™ MOTORIZATION CONTROLS

						
1 CHANNEL REMOTE \$104	15 CHANNEL REMOTE \$122	5 CHANNEL WALL SWITCH* \$94	1 CHANNEL WALL SWITCH \$80	2 CHANNEL WALL SWITCH \$90	15 CHANNEL WALL SWITCH \$98	SUN SENSOR \$66

ALL WALL SWITCHES INCLUDE A DECO-STYLE PLATE

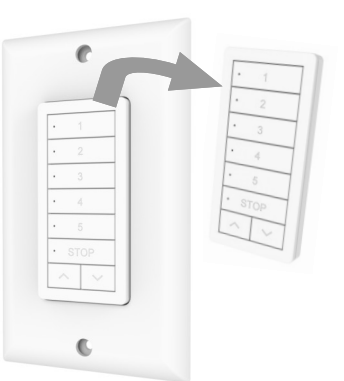

* THE 5 CHANNEL WALL SWITCH IS SURFACE MOUNTED. NO CUT-OUT REQUIRED. IN ADDITION, CONTROL DETACHES & SERVES AS HANDHELD REMOTE.



SOLAR PANEL ACCESSORY
\$130



ARC REPEATER FOR VOLTA
\$156

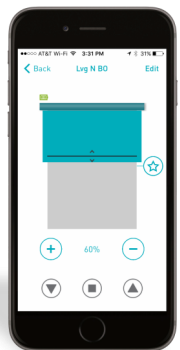

APP CONTROL ACCESSORY WITH WI-FI TO 433 - 2 WAY RF BRIDGE
\$372

OVERSIZED FREIGHT: ANY PRODUCT OVER 90" WIDE IS SUBJECT TO AN OVERSIZED SURCHARGE. SHIPMENTS WITHIN TRADING AREA WILL BE CHARGED \$95 & OUTSIDE TRADING AREA \$125. TRADING AREA INCLUDES TX, LA, NM, OK, MS, TN, AR. SHIPMENTS OVER 12' WILL BE CHARGED AN ADDITIONAL \$100, OVER 15' ADDITIONAL SURCHARGES MAY APPLY FOR RESIDENTIAL SHIP LOCATIONS. SEE TEXTON FREIGHT POLICIES AT WWW.TEXTON.COM/FREIGHT_POLICY.

PG-6

AYANA, BEVERLY, COMO, DAYBREAK, DECO SCREEN 5%, ECO PLANET FR, HAMP-TON, MONTEREY, OPEN LINEN, PLANET FR, PRIMARY BLACKOUT, REGENCY SPC, RITZ, SCREEN 4%, SAMOA, SHEERWEAVE 2000, SHEERWEAVE 2100, SHEERWEAVE 2360, SHEERWEAVE 2390, SHEERWEAVE 2410, SHEERWEAVE 2705, SHEERWEAVE 2710, SHEERWEAVE 4000, SHEERWEAVE 4100, SHEERWEAVE 7500, SHEERWEAVE BASIC 3%, SOLARÉ GT (1, 3, & 5%)*, SOLARÉ GT (SUNSET BLACKOUT)*, VISION 597, VISION 650, VISION CALICO 550, VISION CRYSTAL 550, VISION DESIGNER COLLECTION, ZADIE

* PLUS \$50 NET SURCHARGE PER ORDER.

MOTORS AND INTERNAL LITHIUM ION BATTERY INCLUDED IN SUGGESTED PRICING.

Volta™ QUIET BATTERY & NON BATTERY LOW VOLTAGE SHADES*

	24"	30"	36"	42"	48"	54"	60"	66"	72"	78"	84"	90"	96"	108"	120"	132"	144"	156"	168"	SIDE CHANNEL	
SEE PAGES 3-6 FOR MATERIAL SIZE LIMITATIONS & PAGE 46 FOR PRODUCT SIZE LIMITATIONS.	36"	662	664	666	669	671	673	675	678	680	722	724	726	892	926	961	1,186	1,230	1,274	1,319	53
	48"	666	668	670	669	671	673	675	692	708	767	769	772	943	984	1,025	1,271	1,323	1,375	1,680	71
	60"	670	672	674	669	671	684	704	723	742	812	815	954	995	1,042	1,219	1,355	1,415	1,476	1,796	88
	72"	674	676	678	669	688	710	732	754	776	858	995	999	1,046	1,100	1,283	1,443	1,518	1,593	1,921	106
	84"	678	680	666	686	710	735	760	785	810	903	1,040	1,044	1,098	1,156	1,355	1,542	1,625	1,948	2,047	124
	96"	682	684	678	705	733	761	789	816	844	948	1,085	1,089	1,148	1,224	1,431	1,640	1,733	2,065	2,172	141
	108"	686	664	695	725	756	786	817	848	878	1,126	1,129	1,138	1,209	1,419	1,508	1,739	1,825	2,182	2,298	159
	120"	690	678	712	745	778	812	848	881	914	1,171	1,182	1,192	1,271	1,488	1,585	1,823	2,173	2,298	2,423	176
	132"	694	692	731	767	803	840	876	912	1,077	1,225	1,236	1,247	1,402	1,558	1,647	1,921	2,280	2,415	2,549	194
	144"	670	709	748	787	826	865	904	1,070	1,119	1,278	1,290	1,369	1,463	1,612	1,724	2,020	2,388	2,531	2,675	212
	156"	681	723	765	807	849	891	1,056	1,108	1,160	1,331	1,409	1,424	1,525	1,681	1,801	2,118	2,496	2,648	2,800	229
	168"	692	737	782	827	871	916	1,091	1,146	1,202	1,448	1,463	1,478	1,623	1,751	1,878	2,217	2,603	2,764	2,926	247
SILL CHANNEL		18	22	27	31	36	40	44	49	53	58	62	66	71	80	88	97	106	115	124	

VOLTA BATTERY CHARGER - 42 *PLEASE NOTE- EACH VOLTA NON BATTERY LOW VOLTAGE SHADE INCLUDES 110V. TRANSFORMER POWER SUPPLY.

Volta™ MOTORIZATION CONTROLS

						
1 CHANNEL REMOTE \$104	15 CHANNEL REMOTE \$122	5 CHANNEL WALL SWITCH* \$94	1 CHANNEL WALL SWITCH \$80	2 CHANNEL WALL SWITCH \$90	15 CHANNEL WALL SWITCH \$98	SUN SENSOR \$66

ALL WALL SWITCHES INCLUDE A DECO-STYLE PLATE

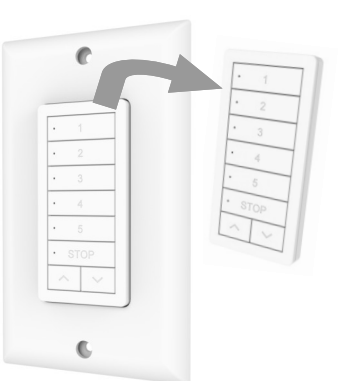

* THE 5 CHANNEL WALL SWITCH IS SURFACE MOUNTED. NO CUT-OUT REQUIRED. IN ADDITION, CONTROL DETACHES & SERVES AS HANDHELD REMOTE.



SOLAR PANEL ACCESSORY
\$130



ARC REPEATER FOR VOLTA
\$156

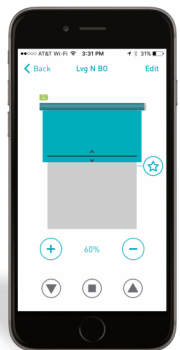

APP CONTROL ACCESSORY WITH WI-FI TO 433 - 2 WAY RF BRIDGE
\$372

OVERSIZED FREIGHT: ANY PRODUCT OVER 90" WIDE IS SUBJECT TO AN OVERSIZED SURCHARGE. SHIPMENTS WITHIN TRADING AREA WILL BE CHARGED \$95 & OUTSIDE TRADING AREA \$125. TRADING AREA INCLUDES TX, LA, NM, OK, MS, TN, AR. SHIPMENTS OVER 12' WILL BE CHARGED AN ADDITIONAL \$100, OVER 15'. ADDITIONAL SURCHARGES MAY APPLY FOR RESIDENTIAL SHIP LOCATIONS. SEE TEXTON FREIGHT POLICIES AT WWW.TEXTON.COM/FREIGHT_POLICY.

PG-7

BANBURY, BASIX (BLACKOUT), BOSTON II (BLACKOUT), BROOME II (BLACKOUT), CARNIVAL, CHATSWORTH, COLOURTEX BLACKOUT, CONCORD II (BLACKOUT), FURY, HARMONY BLACKOUT, LINEN, LOUVOSCREEN + 3%, LOUVOSCREEN + 5%, MERCURY II (BLACKOUT), ODA, OSLO (BLACKOUT), REGATTA, SHEERWEAVE 2500, SHEERWEAVE 2701, SHEERWEAVE 2703, SHEERWEAVE 4400, SHEERWEAVE 4500, SHEERWEAVE 4550, SHEERWEAVE 4600, SHEERWEAVE 4650, SHEERWEAVE 4800, SHEERWEAVE 4901, SHEERWEAVE 4903, SHEERWEAVE 5000, SHEERWEAVE 7100, TOPAZ BLACKOUT, TUSCANY II (BLACKOUT)

Volta™ QUIET BATTERY & NON BATTERY LOW VOLTAGE SHADES*

MOTORS AND INTERNAL LITHIUM ION BATTERY INCLUDED IN SUGGESTED PRICING.

	24"	30"	36"	42"	48"	54"	60"	66"	72"	78"	84"	90"	96"	108"	120"	132"	144"	156"	168"	SIDE CHANNEL	
SEE PAGES 3-6 FOR MATERIAL SIZE LIMITATIONS & PAGE 46 FOR PRODUCT SIZE LIMITATIONS.	36"	689	691	694	696	698	701	703	705	707	757	759	761	932	971	1,010	1,251	1,301	1,351	1,402	53
	48"	693	695	698	696	698	701	703	722	741	811	813	815	993	1,040	1,087	1,352	1,411	1,471	1,784	71
	60"	697	699	702	696	698	714	736	759	781	865	867	1,006	1,054	1,109	1,293	1,453	1,522	1,592	1,920	88
	72"	701	703	694	696	718	744	770	796	822	919	1,055	1,060	1,116	1,178	1,369	1,557	1,642	1,728	2,066	106
	84"	705	707	694	716	745	775	804	833	862	973	1,109	1,114	1,177	1,245	1,453	1,672	1,768	2,102	2,213	124
	96"	709	691	707	740	772	805	838	870	903	1,027	1,163	1,168	1,237	1,324	1,543	1,787	1,893	2,238	2,359	141
	108"	713	691	727	763	799	835	871	907	943	1,213	1,216	1,224	1,308	1,530	1,632	1,902	2,003	2,374	2,505	159
	120"	717	708	747	787	826	866	907	947	986	1,267	1,277	1,288	1,379	1,611	1,721	2,002	2,368	2,510	2,652	176
	132"	689	725	770	813	855	898	941	984	1,156	1,329	1,340	1,351	1,520	1,691	1,795	2,117	2,494	2,646	2,798	194
	144"	698	744	790	836	882	929	975	1,148	1,204	1,391	1,403	1,482	1,592	1,757	1,885	2,232	2,619	2,782	2,944	212
	156"	711	761	810	860	909	959	1,132	1,192	1,252	1,453	1,531	1,545	1,663	1,837	1,974	2,347	2,745	2,918	3,091	229
	168"	725	778	831	884	936	989	1,172	1,236	1,300	1,578	1,593	1,609	1,772	1,917	2,063	2,462	2,870	3,053	3,237	247
SILL CHANNEL		18	22	27	31	36	40	44	49	53	58	62	66	71	80	88	97	106	115	124	

VOLTA BATTERY CHARGER - 42 *PLEASE NOTE- EACH VOLTA NON BATTERY LOW VOLTAGE SHADE INCLUDES 110V. TRANSFORMER POWER SUPPLY.

Volta™ MOTORIZATION CONTROLS

1 CHANNEL REMOTE \$104	15 CHANNEL REMOTE \$122	5 CHANNEL WALL SWITCH* \$94	1 CHANNEL WALL SWITCH \$80	2 CHANNEL WALL SWITCH \$90	15 CHANNEL WALL SWITCH \$98	SUN SENSOR \$66

ALL WALL SWITCHES INCLUDE A DECO-STYLE PLATE

* THE 5 CHANNEL WALL SWITCH IS SURFACE MOUNTED. NO CUT-OUT REQUIRED. IN ADDITION, CONTROL DETACHES & SERVES AS HANDHELD REMOTE.

SOLAR PANEL ACCESSORY
\$130

ARC REPEATER FOR VOLTA
\$156

APP CONTROL ACCESSORY WITH WI-FI TO 433 - 2 WAY RF BRIDGE
\$372

OVERSIZED FREIGHT: ANY PRODUCT OVER 90" WIDE IS SUBJECT TO AN OVERSIZED SURCHARGE. SHIPMENTS WITHIN TRADING AREA WILL BE CHARGED \$95 & OUTSIDE TRADING AREA \$125. TRADING AREA INCLUDES TX, LA, NM, OK, MS, TN, AR. SHIPMENTS OVER 12' WILL BE CHARGED AN ADDITIONAL \$100, OVER 15'. ADDITIONAL SURCHARGES MAY APPLY FOR RESIDENTIAL SHIP LOCATIONS. SEE TEXTON FREIGHT POLICIES AT WWW.TEXTON.COM/FREIGHT_POLICY.

MANUAL CHAIN OPERATED SHADES

PLEASE NOTE- SHADED AREAS OF PRICE TABLE REQUIRE 110V. MOTORIZATION SURCHARGE. SEE 110V. MOTORIZATION SURCHARGES DIRECTLY BELOW THIS PRICE TABLE.

Table with columns for shade widths (24" to 168") and rows for motor types (VOLTA 110V STD. MOTOR, VOLTA 110V QUIET MOTOR, SOMFY 110V QUIET MOTOR, CELTIC II 110V MOTOR) and a SILL CHANNEL row.

Volta™ STANDARD BATTERY & NON BATTERY LOW VOLTAGE SHADES*

MOTORS AND INTERNAL LITHIUM ION BATTERY INCLUDED IN SUGGESTED PRICING.

Table with columns for shade widths (24" to 168") and rows for motor types (VOLTA 110V STD. MOTOR, VOLTA 110V QUIET MOTOR, SOMFY 110V QUIET MOTOR, CELTIC II 110V MOTOR) and a SILL CHANNEL row.

VOLTA BATTERY CHARGER - 42 *PLEASE NOTE- EACH VOLTA NON BATTERY LOW VOLTAGE SHADE INCLUDES 110V. TRANSFORMER POWER SUPPLY.

ADDITIONAL SURCHARGES FOR ALL LISTED PRODUCTS

Table with columns for shade widths (24" to 168") and rows for product types (5" Classic Valance, Magic Touch Cordless, 4" Standard Fascia Painted, 4" Standard Fascia Anodized, 5" Fascia White & Bronze, 5" Fascia Anodized Aluminum, Medium Cassette (100), Large Cassette (120)).

PG-8

BALI, BRESLYN, G RAFF, LYLITH, MAINE, NEWPORT, NIGHT NIGHT, PALISTER, PARTY ANIMALS, SHEERWEAVE INFINITY 2 3%, SHEERWEAVE INFINITY 2 5%, VISION 350 STYLES (10%)

MOTORS AND INTERNAL LITHIUM ION BATTERY INCLUDED IN SUGGESTED PRICING.

Volta™ QUIET BATTERY & NON BATTERY LOW VOLTAGE SHADES*

	24"	30"	36"	42"	48"	54"	60"	66"	72"	78"	84"	90"	96"	108"	120"	132"	144"	156"	168"	SIDE CHANNEL	
SEE PAGES 3-6 FOR MATERIAL SIZE LIMITATIONS & PAGE 46 FOR PRODUCT SIZE LIMITATIONS.	36"	731	733	736	738	740	743	745	747	749	810	812	815	992	1,039	1,086	1,351	1,411	1,470	1,529	53
	48"	735	737	740	738	740	743	745	768	791	878	880	882	1,069	1,125	1,182	1,477	1,548	1,619	1,943	71
	60"	739	741	744	738	740	759	787	814	842	945	947	1,086	1,145	1,211	1,407	1,604	1,686	1,770	2,112	88
	72"	743	745	748	738	765	797	829	860	892	1,012	1,149	1,153	1,222	1,298	1,502	1,733	1,834	1,935	2,290	106
	84"	747	749	736	763	799	835	871	907	943	1,080	1,216	1,221	1,298	1,382	1,606	1,873	1,987	2,340	2,468	124
	96"	751	733	752	792	832	873	913	953	993	1,147	1,284	1,288	1,373	1,478	1,714	2,013	2,139	2,505	2,646	141
	108"	755	733	777	822	866	911	955	999	1,044	1,347	1,350	1,358	1,460	1,701	1,822	2,153	2,277	2,671	2,825	159
	120"	759	754	803	851	900	948	999	1,048	1,096	1,414	1,424	1,435	1,547	1,799	1,930	2,278	2,669	2,836	3,003	176
	132"	731	775	830	883	936	989	1,041	1,094	1,276	1,489	1,501	1,512	1,703	1,896	2,023	2,418	2,822	3,002	3,181	194
	144"	741	798	855	912	969	1,026	1,083	1,268	1,334	1,565	1,577	1,656	1,789	1,979	2,132	2,558	2,975	3,167	3,359	212
	156"	758	819	881	942	1,003	1,064	1,249	1,321	1,392	1,640	1,718	1,733	1,876	2,076	2,240	2,698	3,128	3,333	3,538	229
	168"	775	841	906	971	1,037	1,102	1,298	1,374	1,450	1,779	1,794	1,809	2,000	2,174	2,348	2,838	3,280	3,498	3,716	247
SILL CHANNEL	18	22	27	31	36	40	44	49	53	58	62	66	71	80	88	97	106	115	124		

VOLTA BATTERY CHARGER - 42 *PLEASE NOTE- EACH VOLTA NON BATTERY LOW VOLTAGE SHADE INCLUDES 110V. TRANSFORMER POWER SUPPLY.

Volta™ MOTORIZATION CONTROLS

						
1 CHANNEL REMOTE \$104	15 CHANNEL REMOTE \$122	5 CHANNEL WALL SWITCH* \$94	1 CHANNEL WALL SWITCH \$80	2 CHANNEL WALL SWITCH \$90	15 CHANNEL WALL SWITCH \$98	SUN SENSOR \$66

ALL WALL SWITCHES INCLUDE A DECO-STYLE PLATE

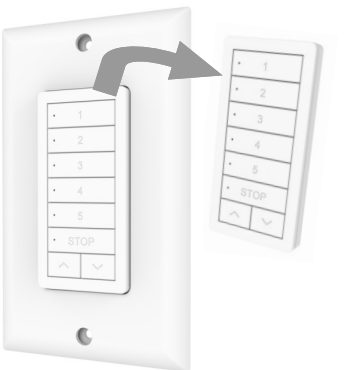

* THE 5 CHANNEL WALL SWITCH IS SURFACE MOUNTED. NO CUT-OUT REQUIRED. IN ADDITION, CONTROL DETACHES & SERVES AS HANDHELD REMOTE.



SOLAR PANEL ACCESSORY
\$130



ARC REPEATER FOR VOLTA
\$156

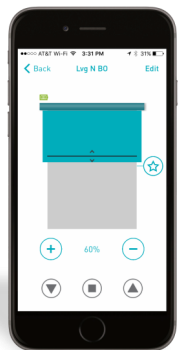

APP CONTROL ACCESSORY WITH WI-FI TO 433 - 2 WAY RF BRIDGE
\$372

OVERSIZED FREIGHT: ANY PRODUCT OVER 90" WIDE IS SUBJECT TO AN OVERSIZED SURCHARGE. SHIPMENTS WITHIN TRADING AREA WILL BE CHARGED \$95 & OUTSIDE TRADING AREA \$125. TRADING AREA INCLUDES TX, LA, NM, OK, MS, TN, AR. SHIPMENTS OVER 12' WILL BE CHARGED AN ADDITIONAL \$100, OVER 15'. ADDITIONAL SURCHARGES MAY APPLY FOR RESIDENTIAL SHIP LOCATIONS. SEE TEXTON FREIGHT POLICIES AT WWW.TEXTON.COM/FREIGHT_POLICY.

PG-9

CHENILLE, FARRAH, HELSINKI, PARADISE, PEBBLES, SHEERWEAVE 7000, SHEERWEAVE PERFORMANCE PLUS 2390, SHEERWEAVE PERFORMANCE PLUS 2410, SHOT SILK, STRATA SPC®

Volta™ QUIET BATTERY & NON BATTERY LOW VOLTAGE SHADES*

MOTORS AND INTERNAL LITHIUM ION BATTERY INCLUDED IN SUGGESTED PRICING.

	24"	30"	36"	42"	48"	54"	60"	66"	72"	78"	84"	90"	96"	108"	120"	132"	144"	156"	168"	SIDE CHANNEL	
SEE PAGES 3-6 FOR MATERIAL SIZE LIMITATIONS & PAGE 46 FOR PRODUCT SIZE LIMITATIONS.	36"	725	728	730	732	735	737	760	785	810	902	904	907	1,097	1,157	1,217	1,524	1,599	1,674	1,749	53
	48"	729	732	734	732	755	786	816	847	877	993	995	997	1,200	1,272	1,345	1,693	1,783	1,874	2,218	71
	60"	733	736	730	764	800	837	873	909	945	1,083	1,085	1,224	1,302	1,388	1,603	1,862	1,968	2,075	2,441	88
	72"	737	728	762	804	846	887	929	971	1,013	1,173	1,310	1,314	1,405	1,503	1,731	2,034	2,163	2,292	2,674	106
	84"	741	748	796	843	891	938	986	1,033	1,081	1,264	1,400	1,405	1,508	1,617	1,867	2,217	2,363	2,747	2,907	124
	96"	745	777	830	883	936	989	1,042	1,095	1,148	1,354	1,491	1,495	1,609	1,743	2,008	2,401	2,563	2,964	3,140	141
	108"	746	805	864	922	981	1,040	1,099	1,157	1,216	1,577	1,580	1,588	1,721	1,995	2,148	2,584	2,747	3,180	3,373	159
	120"	769	833	897	962	1,026	1,091	1,157	1,222	1,286	1,667	1,677	1,688	1,834	2,122	2,289	2,752	3,187	3,397	3,606	176
	132"	791	861	934	1,004	1,074	1,144	1,214	1,284	1,483	1,765	1,776	1,788	2,016	2,249	2,415	2,935	3,387	3,613	3,840	194
	144"	816	892	968	1,043	1,119	1,195	1,270	1,473	1,558	1,864	1,876	1,955	2,129	2,361	2,556	3,118	3,586	3,829	4,073	212
	156"	839	920	1,001	1,083	1,164	1,245	1,451	1,542	1,634	1,962	2,040	2,055	2,242	2,488	2,697	3,301	3,786	4,046	4,306	229
	168"	861	948	1,035	1,122	1,209	1,296	1,513	1,611	1,709	2,124	2,139	2,154	2,392	2,615	2,838	3,485	3,986	4,262	4,539	247
SILL CHANNEL		18	22	27	31	36	40	44	49	53	58	62	66	71	80	88	97	106	115	124	

VOLTA BATTERY CHARGER - 42 *PLEASE NOTE- EACH VOLTA NON BATTERY LOW VOLTAGE SHADE INCLUDES 110V. TRANSFORMER POWER SUPPLY.

Volta™ MOTORIZATION CONTROLS

						
1 CHANNEL REMOTE \$104	15 CHANNEL REMOTE \$122	5 CHANNEL WALL SWITCH* \$94	1 CHANNEL WALL SWITCH \$80	2 CHANNEL WALL SWITCH \$90	15 CHANNEL WALL SWITCH \$98	SUN SENSOR \$66

ALL WALL SWITCHES INCLUDE A DECO-STYLE PLATE

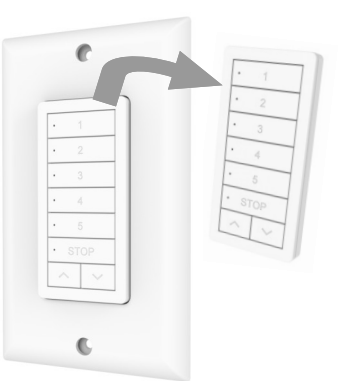

* THE 5 CHANNEL WALL SWITCH IS SURFACE MOUNTED. NO CUT-OUT REQUIRED. IN ADDITION, CONTROL DETACHES & SERVES AS HANDHELD REMOTE.



SOLAR PANEL ACCESSORY
\$130



ARC REPEATER FOR VOLTA
\$156

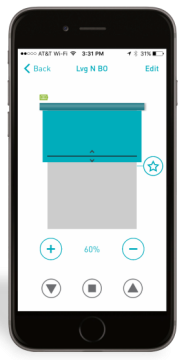

APP CONTROL ACCESSORY WITH WI-FI TO 433 - 2 WAY RF BRIDGE
\$372

OVERSIZED FREIGHT: ANY PRODUCT OVER 90" WIDE IS SUBJECT TO AN OVERSIZED SURCHARGE. SHIPMENTS WITHIN TRADING AREA WILL BE CHARGED \$95 & OUTSIDE TRADING AREA \$125. TRADING AREA INCLUDES TX, LA, NM, OK, MS, TN, AR. SHIPMENTS OVER 12' WILL BE CHARGED AN ADDITIONAL \$100, OVER 15'. ADDITIONAL SURCHARGES MAY APPLY FOR RESIDENTIAL SHIP LOCATIONS. SEE TEXTON FREIGHT POLICIES AT WWW.TEXTON.COM/FREIGHT_POLICY.

PG-10

Volta™ QUIET BATTERY & NON BATTERY LOW VOLTAGE SHADES*

MOTORS AND INTERNAL LITHIUM ION BATTERY INCLUDED IN SUGGESTED PRICING.

	24"	30"	36"	42"	48"	54"	60"	66"	72"	78"	84"	90"	96"	108"	120"	132"	144"	156"	168"	SIDE CHANNEL	
SEE PAGES 3-6 FOR MATERIAL SIZE LIMITATIONS & PAGE 46 FOR PRODUCT SIZE LIMITATIONS.	36"	769	771	774	776	778	780	808	837	867	979	981	983	1,184	1,255	1,326	1,667	1,755	1,844	1,932	53
	48"	773	775	778	776	803	840	876	913	949	1,088	1,091	1,093	1,308	1,395	1,481	1,873	1,979	2,086	2,446	71
	60"	777	779	782	815	858	901	945	988	1,031	1,198	1,200	1,339	1,433	1,535	1,766	2,078	2,203	2,330	2,715	88
	72"	781	783	812	862	913	963	1,013	1,063	1,113	1,307	1,444	1,448	1,557	1,675	1,921	2,286	2,437	2,589	2,994	106
	84"	785	796	853	910	967	1,024	1,081	1,139	1,196	1,417	1,554	1,558	1,682	1,813	2,085	2,505	2,676	3,087	3,273	124
	96"	789	831	894	958	1,022	1,086	1,150	1,214	1,278	1,526	1,663	1,667	1,805	1,963	2,253	2,724	2,915	3,346	3,552	141
	108"	794	865	935	1,006	1,077	1,148	1,218	1,289	1,360	1,768	1,771	1,780	1,939	2,240	2,421	2,943	3,139	3,605	3,831	159
	120"	821	899	977	1,054	1,132	1,209	1,289	1,367	1,444	1,878	1,888	1,899	2,074	2,392	2,589	3,147	3,618	3,864	4,109	176
	132"	849	933	1,020	1,104	1,189	1,273	1,358	1,442	1,656	1,995	2,006	2,018	2,278	2,543	2,742	3,366	3,857	4,123	4,388	194
	144"	878	970	1,061	1,152	1,243	1,335	1,426	1,644	1,745	2,113	2,125	2,204	2,412	2,680	2,910	3,585	4,096	4,382	4,667	212
	156"	906	1,004	1,102	1,200	1,298	1,396	1,618	1,727	1,835	2,231	2,308	2,323	2,547	2,831	3,078	3,804	4,335	4,640	4,946	229
	168"	933	1,038	1,143	1,248	1,353	1,458	1,693	1,809	1,924	2,411	2,426	2,442	2,718	2,982	3,246	4,024	4,574	4,899	5,225	247
SILL CHANNEL	18	22	27	31	36	40	44	49	53	58	62	66	71	80	88	97	106	115	124		

VOLTA BATTERY CHARGER - 42 *PLEASE NOTE- EACH VOLTA NON BATTERY LOW VOLTAGE SHADE INCLUDES 110V. TRANSFORMER POWER SUPPLY.

Volta™ MOTORIZATION CONTROLS

						
1 CHANNEL REMOTE \$104	15 CHANNEL REMOTE \$122	5 CHANNEL WALL SWITCH* \$94	1 CHANNEL WALL SWITCH \$80	2 CHANNEL WALL SWITCH \$90	15 CHANNEL WALL SWITCH \$98	SUN SENSOR \$66

ALL WALL SWITCHES INCLUDE A DECO-STYLE PLATE

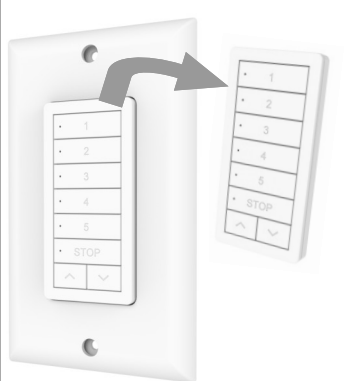

* THE 5 CHANNEL WALL SWITCH IS SURFACE MOUNTED. NO CUT-OUT REQUIRED. IN ADDITION, CONTROL DETACHES & SERVES AS HANDHELD REMOTE.



SOLAR PANEL ACCESSORY
\$130



ARC REPEATER FOR VOLTA
\$156

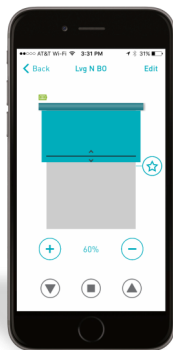

APP CONTROL ACCESSORY WITH WI-FI TO 433 - 2 WAY RF BRIDGE
\$372

OVERSIZED FREIGHT: ANY PRODUCT OVER 90" WIDE IS SUBJECT TO AN OVERSIZED SURCHARGE. SHIPMENTS WITHIN TRADING AREA WILL BE CHARGED \$95 & OUTSIDE TRADING AREA \$125. TRADING AREA INCLUDES TX, LA, NM, OK, MS, TN, AR. SHIPMENTS OVER 12' WILL BE CHARGED AN ADDITIONAL \$100, OVER 15' ADDITIONAL SURCHARGES MAY APPLY FOR RESIDENTIAL SHIP LOCATIONS. SEE TEXTON FREIGHT POLICIES AT WWW.TEXTON.COM/FREIGHT_POLICY.

NEOLUX
PG-1

ARCADIA, CAICOS, COMFORT DIM OUT, CANCUN, CRYSTAL, FIJI, HORIZON, LINEN, LUXURY, SERENADE, SOFT

NEOLUX CHAIN OPERATED SHADES

ALL NEOLUX SHADES COME WITH MEDIUM CASSETTES AND LARGE CASSETTES WHEN NEEDED.

	24"	30"	36"	42"	48"	54"	60"	66"	72"	78"	84"	90"	96"	108"
36"	220	232	242	290	300	312	428	440	450	462	476	488	540	464
48"	242	252	264	320	332	342	488	500	510	522	536	574	600	524
60"	262	274	286	350	362	372	548	560	570	584	596	646	660	584
72"	284	296	306	382	392	404	608	620	638	648	710	724	736	662
84"	306	316	328	412	424	434	668	678	698	708	770	784	798	730
96"	326	338	348	444	454	466	728	738	758	768	830	844	864	790
102"	348	358	370	474	486	496	788	806	822	878	898	912	924	976

	30"	36"	42"	48"	54"	60"	66"	72"	78"	84"	90"	96"	108"
VOLTA 110V STD. MOTOR	409	414	418	423	427	430	432	436	440	445	447	449	458
VOLTA 110V QUIET MOTOR	605	609	614	616	618	623	627	632	634	636	640	645	649
SOMFY 110V QUIET MOTOR	733	735	737	738	740	742	743	745	747	748	750	752	835
CELTIC II 110V MOTOR	392	396	400	405	409	412	414	418	423	427	430	432	440

All Motors Use Radio Receivers and Controls.

SOMFY LI-ION BATTERY MOTORIZATION— 400 SOMFY LI-ION BATTERY CHARGER — 60 SOMFY ST30 24V. MOTORIZATION— 730
 CELTIC RECHARGEABLE BATTERY MOTORIZATION— 328 CELTIC BATTERY CHARGER — 60 SOMFY & CELTIC MOTOR CONTROLS ON PAGE 47.

Volta™ STANDARD BATTERY & LOW VOLTAGE NEOLUX SHADES*

MOTORS INCLUDED IN SUGGESTED PRICING.

ALL NEOLUX SHADES COME WITH MEDIUM CASSETTES AND LARGE CASSETTES WHEN NEEDED.

	24"	30"	36"	42"	48"	54"	60"	66"	72"	78"	84"	90"	96"	108"
36"	457	543	553	601	611	623	739	751	761	773	937	949	1,001	925
48"	553	563	575	631	643	653	799	811	821	833	997	1,035	1,061	985
60"	574	585	596	662	673	684	859	871	885	971	1,084	1,110	1,129	1,088
72"	595	607	617	693	703	715	919	931	949	1,109	1,171	1,185	1,197	1,190
84"	617	627	639	723	735	745	979	989	1,009	1,169	1,231	1,245	1,326	1,258
96"	638	648	660	754	766	776	1,039	1,053	1,071	1,254	1,295	1,343	1,389	1,381
102"	659	669	681	785	797	807	1,099	1,117	1,133	1,339	1,359	1,440	1,452	1,504

VOLTA BATTERY CHARGER — 42

*PLEASE NOTE- EACH VOLTA LOW VOLTAGE SHADE INCLUDES POWER SUPPLY.

Volta™ QUIET BATTERY & LOW VOLTAGE NEOLUX SHADES*

MOTORS INCLUDED IN SUGGESTED PRICING.

ALL NEOLUX SHADES COME WITH MEDIUM CASSETTES AND LARGE CASSETTES WHEN NEEDED.

	24"	30"	36"	42"	48"	54"	60"	66"	72"	78"	84"	90"	96"	108"
36"	598	610	620	668	678	690	806	818	828	840	965	977	1,031	953
48"	620	630	642	698	710	720	866	878	888	900	1,027	1,066	1,093	1,015
60"	641	652	663	729	740	751	926	938	952	1,021	1,117	1,143	1,163	1,120
72"	662	674	684	760	770	782	986	998	1,016	1,142	1,206	1,221	1,233	1,226
84"	684	694	706	790	802	812	1,046	1,056	1,076	1,204	1,268	1,282	1,366	1,296
96"	705	715	727	821	833	843	1,106	1,179	1,197	1,292	1,334	1,383	1,431	1,422
102"	726	736	748	852	864	874	1,166	1,301	1,317	1,379	1,400	1,483	1,496	1,549

*PLEASE NOTE- EACH VOLTA LOW VOLTAGE SHADE INCLUDES POWER SUPPLY.

Volta™ MOTORIZATION CONTROLS

						
1 CHANNEL REMOTE \$104	15 CHANNEL REMOTE \$122	5 CHANNEL WALL SWITCH* \$94	1 CHANNEL WALL SWITCH \$80	2 CHANNEL WALL SWITCH \$90	15 CHANNEL WALL SWITCH \$98	SUN SENSOR \$66

ALL WALL SWITCHES INCLUDE A DECO-STYLE PLATE COVER.

NEOLUX CLASSIC DIM OUT, GLAMOUR, MADEIRA, MYKONOS DIM OUT, NAPA, ROYAL, RUSTIC DIM OUT, SHEER
PG-2 VISION, SPLENDOR

NEOLUX CHAIN OPERATED SHADES

ALL NEOLUX SHADES COME WITH MEDIUM CASSETTES AND LARGE CASSETTES WHEN NEEDED.

	24"	30"	36"	42"	48"	54"	60"	66"	72"	78"	84"	90"	96"	108"
36"	244	256	266	324	336	346	500	510	522	532	548	558	610	536
48"	272	282	294	366	376	388	578	590	600	612	626	664	690	614
60"	300	310	322	406	416	428	658	670	680	694	706	756	770	694
72"	328	338	350	446	458	468	738	748	766	778	840	852	866	790
84"	354	366	378	486	498	510	816	828	846	858	920	932	946	878
96"	382	394	404	528	538	550	896	906	926	936	998	1,012	1,032	958
102"	410	422	432	568	580	590	974	994	1,008	1,066	1,086	1,098	1,112	1,164

	30"	36"	42"	48"	54"	60"	66"	72"	78"	84"	90"	96"	108"
VOLTA 110V STD. MOTOR	409	414	418	423	427	430	432	436	440	445	447	449	458
VOLTA 110V QUIET MOTOR	605	609	614	616	618	623	627	632	634	636	640	645	649
SOMFY 110V QUIET MOTOR	733	735	737	738	740	742	743	745	747	748	750	752	835
CELTIC II 110V MOTOR	392	396	400	405	409	412	414	418	423	427	430	432	440

All Motors Use Radio Receivers and Controls.

SOMFY LI-ION BATTERY MOTORIZATION— 400 SOMFY LI-ION BATTERY CHARGER — 60 SOMFY ST30 24V. MOTORIZATION— 730
 CELTIC RECHARGEABLE BATTERY MOTORIZATION— 328 CELTIC BATTERY CHARGER — 60 **SOMFY & CELTIC MOTOR CONTROLS ON PAGE 47.**

Volta™ STANDARD BATTERY & LOW VOLTAGE NEOLUX SHADES*

MOTORS INCLUDED IN SUGGESTED PRICING.

ALL NEOLUX SHADES COME WITH MEDIUM CASSETTES AND LARGE CASSETTES WHEN NEEDED.

	24"	30"	36"	42"	48"	54"	60"	66"	72"	78"	84"	90"	96"	108"
36"	481	567	577	635	647	657	811	821	833	843	1,009	1,019	1,071	997
48"	583	593	605	677	687	699	889	901	911	923	1,087	1,125	1,151	1,075
60"	611	621	633	717	728	739	969	980	994	1,081	1,194	1,219	1,239	1,197
72"	639	649	661	757	769	779	1,049	1,059	1,077	1,239	1,301	1,313	1,327	1,318
84"	665	677	689	797	809	821	1,127	1,139	1,157	1,319	1,381	1,393	1,474	1,406
96"	693	705	716	838	850	861	1,206	1,222	1,238	1,423	1,464	1,510	1,557	1,549
102"	721	733	743	879	891	901	1,285	1,305	1,319	1,527	1,547	1,626	1,640	1,692

VOLTA BATTERY CHARGER — 42

*PLEASE NOTE- EACH VOLTA LOW VOLTAGE SHADE INCLUDES POWER SUPPLY.

Volta™ QUIET BATTERY & LOW VOLTAGE NEOLUX SHADES*

MOTORS INCLUDED IN SUGGESTED PRICING.

ALL NEOLUX SHADES COME WITH MEDIUM CASSETTES AND LARGE CASSETTES WHEN NEEDED.

	24"	30"	36"	42"	48"	54"	60"	66"	72"	78"	84"	90"	96"	108"
36"	622	634	644	702	714	724	878	888	900	910	1,039	1,050	1,103	1,027
48"	650	660	672	744	754	766	956	968	978	990	1,120	1,159	1,186	1,107
60"	678	688	700	784	795	806	1,036	1,047	1,061	1,133	1,230	1,256	1,276	1,232
72"	706	716	728	824	836	846	1,116	1,126	1,144	1,276	1,340	1,352	1,367	1,358
84"	732	744	756	864	876	888	1,194	1,206	1,224	1,359	1,422	1,435	1,518	1,448
96"	760	772	783	905	917	928	1,273	1,348	1,364	1,466	1,508	1,555	1,604	1,595
102"	788	800	810	946	958	968	1,352	1,489	1,503	1,573	1,593	1,675	1,689	1,743

*PLEASE NOTE- EACH VOLTA LOW VOLTAGE SHADE INCLUDES POWER SUPPLY.

Volta™ MOTORIZATION CONTROLS (CONTINUED FROM PRIOR PAGE)

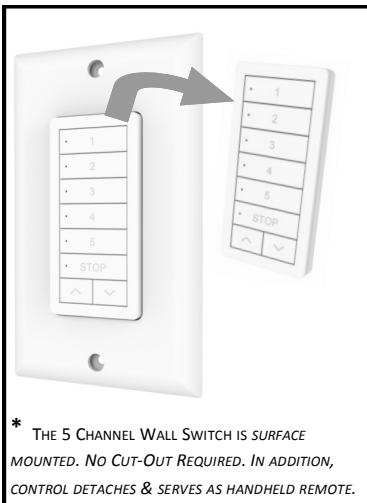

* THE 5 CHANNEL WALL SWITCH IS SURFACE MOUNTED. NO CUT-OUT REQUIRED. IN ADDITION, CONTROL DETACHES & SERVES AS HANDHELD REMOTE.



SOLAR PANEL ACCESSORY
\$130



ARC REPEATER FOR VOLTA
\$156

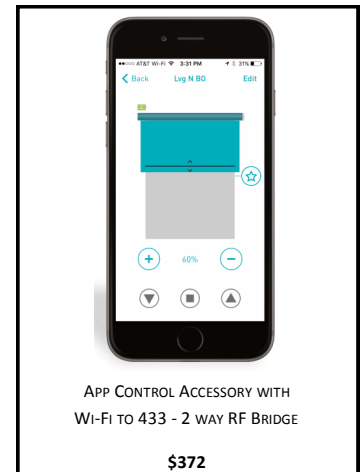

APP CONTROL ACCESSORY WITH WI-FI TO 433 - 2 WAY RF BRIDGE
\$372

VISION
PG-1

CAPRI

VISION CHAIN OPERATED SHADES

ALL VISION SHADES COME WITH MEDIUM CASSETTES AND LARGE CASSETTES WHEN NEEDED.

	24"	30"	36"	42"	48"	54"	60"	66"	72"	78"	84"	90"	96"	108"
36"	198	208	220	254	266	276	360	370	382	392	408	418	470	396
48"	212	224	234	276	288	298	400	412	422	434	448	486	512	436
60"	228	238	250	298	308	320	442	452	464	478	490	540	552	478
72"	242	254	264	318	330	340	482	494	512	522	584	598	610	536
84"	258	268	280	340	352	362	524	534	552	564	626	640	652	584
96"	272	284	294	362	372	384	564	576	594	604	668	680	700	626
102"	288	298	310	384	394	406	606	624	638	696	716	728	742	794

	30"	36"	42"	48"	54"	60"	66"	72"	78"	84"	90"	96"	108"
VOLTA 110V STD. MOTOR	409	414	418	423	427	430	432	436	440	445	447	449	458
VOLTA 110V QUIET MOTOR	605	609	614	616	618	623	627	632	634	636	640	645	649
SOMFY 110V QUIET MOTOR	733	735	737	738	740	742	743	745	747	748	750	752	835
CELTIC II 110V MOTOR	392	396	400	405	409	412	414	418	423	427	430	432	440

All Motors Use Radio Receivers and Controls.

SOMFY LI-ION BATTERY MOTORIZATION— 400 SOMFY LI-ION BATTERY CHARGER — 60 SOMFY ST30 24V. MOTORIZATION— 730
 CELTIC RECHARGEABLE BATTERY MOTORIZATION— 328 CELTIC BATTERY CHARGER — 60 SOMFY & CELTIC MOTOR CONTROLS ON PAGE 47.

Volta™ STANDARD BATTERY & LOW VOLTAGE VISION SHADES*

MOTORS INCLUDED IN SUGGESTED PRICING.

ALL VISION SHADES COME WITH MEDIUM CASSETTES AND LARGE CASSETTES WHEN NEEDED.

	24"	30"	36"	42"	48"	54"	60"	66"	72"	78"	84"	90"	96"	108"
36"	435	519	531	565	577	587	671	681	693	703	869	879	931	857
48"	523	535	545	587	599	609	711	723	733	745	909	947	973	897
60"	538	550	560	608	620	630	752	764	778	864	977	1,003	1,022	981
72"	553	565	575	629	641	651	793	805	823	983	1,045	1,059	1,071	1,064
84"	569	579	591	651	663	673	835	845	863	1,025	1,087	1,101	1,180	1,112
96"	584	594	606	673	684	695	876	890	906	1,091	1,132	1,179	1,225	1,217
102"	599	609	621	695	705	717	917	935	949	1,157	1,177	1,256	1,270	1,322

VOLTA BATTERY CHARGER — 42

*PLEASE NOTE- EACH VOLTA LOW VOLTAGE SHADE INCLUDES POWER SUPPLY.

Volta™ QUIET BATTERY & LOW VOLTAGE VISION SHADES*



MOTORS INCLUDED IN SUGGESTED PRICING.

ALL VISION SHADES COME WITH MEDIUM CASSETTES AND LARGE CASSETTES WHEN NEEDED.

	24"	30"	36"	42"	48"	54"	60"	66"	72"	78"	84"	90"	96"	108"
36"	576	586	598	632	644	654	738	748	760	770	895	905	959	883
48"	590	602	612	654	666	676	778	790	800	812	936	975	1,002	924
60"	605	617	627	675	687	697	819	831	845	912	1,006	1,033	1,053	1,010
72"	620	632	642	696	708	718	860	872	890	1,012	1,076	1,091	1,103	1,096
84"	636	646	658	718	730	740	902	912	930	1,056	1,120	1,134	1,215	1,145
96"	651	661	673	740	751	762	943	1,016	1,032	1,124	1,166	1,214	1,262	1,254
102"	666	676	688	762	772	784	984	1,119	1,133	1,192	1,212	1,294	1,308	1,362

*PLEASE NOTE- EACH VOLTA LOW VOLTAGE SHADE INCLUDES POWER SUPPLY.

Volta™ MOTORIZATION CONTROLS

						
1 CHANNEL REMOTE \$104	15 CHANNEL REMOTE \$122	5 CHANNEL WALL SWITCH* \$94	1 CHANNEL WALL SWITCH \$80	2 CHANNEL WALL SWITCH \$90	15 CHANNEL WALL SWITCH \$98	SUN SENSOR \$66

ALL WALL SWITCHES INCLUDE A DECO-STYLE PLATE COVER.

VISION CAPRI COLOUR, CAPRI BLACK,
PG-2

VISION CHAIN OPERATED SHADES

ALL VISION SHADES COME WITH MEDIUM CASSETTES AND LARGE CASSETTES WHEN NEEDED.

	24"	30"	36"	42"	48"	54"	60"	66"	72"	78"	84"	90"	96"	108"
36"	208	218	230	270	280	292	390	400	412	424	438	450	502	426
48"	226	236	248	296	306	318	440	450	462	472	488	524	550	476
60"	244	254	266	322	332	344	488	500	510	526	536	586	600	524
72"	260	272	282	346	358	368	538	548	568	578	640	654	666	590
84"	278	290	300	372	384	394	588	598	616	628	690	704	716	648
96"	296	308	318	398	408	420	636	648	666	678	740	752	772	698
102"	314	324	336	424	434	446	686	704	720	776	796	810	822	876

	30"	36"	42"	48"	54"	60"	66"	72"	78"	84"	90"	96"	108"
VOLTA 110V STD. MOTOR	409	414	418	423	427	430	432	436	440	445	447	449	458
VOLTA 110V QUIET MOTOR	605	609	614	616	618	623	627	632	634	636	640	645	649
SOMFY 110V QUIET MOTOR	733	735	737	738	740	742	743	745	747	748	750	752	835
CELTIC II 110V MOTOR	392	396	400	405	409	412	414	418	423	427	430	432	440

All Motors Use Radio Receivers and Controls.

SOMFY LI-ION BATTERY MOTORIZATION— 400 SOMFY LI-ION BATTERY CHARGER — 60 SOMFY ST30 24V. MOTORIZATION— 730
CELTIC RECHARGEABLE BATTERY MOTORIZATION— 328 CELTIC BATTERY CHARGER — 60 **SOMFY & CELTIC MOTOR CONTROLS ON PAGE 47.**

Volta™ STANDARD BATTERY & LOW VOLTAGE VISION SHADES*

MOTORS INCLUDED IN SUGGESTED PRICING.

ALL VISION SHADES COME WITH MEDIUM CASSETTES AND LARGE CASSETTES WHEN NEEDED.

	24"	30"	36"	42"	48"	54"	60"	66"	72"	78"	84"	90"	96"	108"
36"	445	529	541	581	591	603	701	711	723	735	899	911	963	887
48"	537	547	559	607	617	629	751	761	773	783	949	985	1,011	937
60"	554	565	576	632	643	654	800	810	826	911	1,025	1,050	1,069	1,028
72"	571	583	593	657	669	679	849	859	879	1,039	1,101	1,115	1,127	1,118
84"	589	601	611	683	695	705	899	909	927	1,089	1,151	1,165	1,244	1,176
96"	607	618	629	709	720	731	948	962	979	1,163	1,204	1,252	1,297	1,290
102"	625	635	647	735	745	757	997	1,015	1,031	1,237	1,257	1,338	1,350	1,404

VOLTA BATTERY CHARGER — 42

*PLEASE NOTE- EACH VOLTA LOW VOLTAGE SHADE INCLUDES POWER SUPPLY.

Volta™ QUIET BATTERY & LOW VOLTAGE VISION SHADES*

MOTORS INCLUDED IN SUGGESTED PRICING.

ALL VISION SHADES COME WITH MEDIUM CASSETTES AND LARGE CASSETTES WHEN NEEDED.

	24"	30"	36"	42"	48"	54"	60"	66"	72"	78"	84"	90"	96"	108"
36"	586	596	608	648	658	670	768	778	790	802	926	938	992	914
48"	604	614	626	674	684	696	818	828	840	850	977	1,015	1,041	965
60"	621	632	643	699	710	721	867	877	893	960	1,056	1,082	1,101	1,058
72"	638	650	660	724	736	746	916	926	946	1,070	1,134	1,148	1,161	1,152
84"	656	668	678	750	762	772	966	976	994	1,122	1,186	1,200	1,281	1,211
96"	674	685	696	776	787	798	1,015	1,088	1,105	1,198	1,240	1,289	1,336	1,329
102"	692	702	714	802	812	824	1,064	1,199	1,215	1,274	1,295	1,378	1,391	1,446

*PLEASE NOTE- EACH VOLTA LOW VOLTAGE SHADE INCLUDES POWER SUPPLY.

Volta™ MOTORIZATION CONTROLS (CONTINUED FROM PRIOR PAGE)

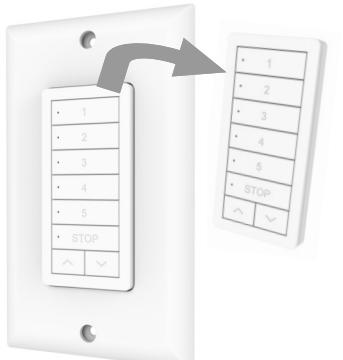

* THE 5 CHANNEL WALL SWITCH IS SURFACE MOUNTED. NO CUT-OUT REQUIRED. IN ADDITION, CONTROL DETACHES & SERVES AS HANDHELD REMOTE.



SOLAR PANEL ACCESSORY
\$130



ARC REPEATER FOR VOLTA
\$156

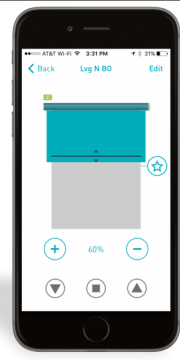

APP CONTROL ACCESSORY WITH WI-FI TO 433 - 2 WAY RF BRIDGE
\$372

VISION FLORENCE, VENICE, VERONA
PG-3

VISION CHAIN OPERATED SHADES

ALL VISION SHADES COME WITH MEDIUM CASSETTES AND LARGE CASSETTES WHEN NEEDED.

	24"	30"	36"	42"	48"	54"	60"	66"	72"	78"	84"	90"	96"	108"
36"	234	246	258	310	322	332	472	482	494	506	520	532	584	508
48"	260	272	282	348	358	370	544	554	566	576	592	628	654	580
60"	286	296	308	384	396	406	616	626	638	652	664	714	726	652
72"	310	322	332	422	432	444	686	698	716	728	790	802	816	740
84"	336	346	358	458	470	480	758	770	788	800	862	874	888	820
96"	360	372	382	494	506	516	830	842	860	870	934	946	966	892
102"	386	398	408	532	542	554	902	920	936	992	1,012	1,026	1,038	1,092

	30"	36"	42"	48"	54"	60"	66"	72"	78"	84"	90"	96"	108"
VOLTA 110V STD. MOTOR	409	414	418	423	427	430	432	436	440	445	447	449	458
VOLTA 110V QUIET MOTOR	605	609	614	616	618	623	627	632	634	636	640	645	649
SOMFY 110V QUIET MOTOR	733	735	737	738	740	742	743	745	747	748	750	752	835
CELTIC II 110V MOTOR	392	396	400	405	409	412	414	418	423	427	430	432	440

All Motors Use Radio Receivers and Controls.

SOMFY LI-ION BATTERY MOTORIZATION— 400 SOMFY LI-ION BATTERY CHARGER — 60 SOMFY ST30 24V. MOTORIZATION— 730
CELTIC RECHARGEABLE BATTERY MOTORIZATION— 328 CELTIC BATTERY CHARGER — 60 SOMFY & CELTIC MOTOR CONTROLS ON PAGE 47.

Volta™ STANDARD BATTERY & LOW VOLTAGE VISION SHADES*

MOTORS INCLUDED IN SUGGESTED PRICING.

ALL VISION SHADES COME WITH MEDIUM CASSETTES AND LARGE CASSETTES WHEN NEEDED.

	24"	30"	36"	42"	48"	54"	60"	66"	72"	78"	84"	90"	96"	108"
36"	471	557	569	621	633	643	783	793	805	817	981	993	1,045	969
48"	571	583	593	659	669	681	855	865	877	887	1,053	1,089	1,115	1,041
60"	596	608	618	696	706	718	926	937	952	1,038	1,152	1,176	1,196	1,155
72"	621	633	643	733	743	755	997	1,009	1,027	1,189	1,251	1,263	1,277	1,268
84"	647	657	669	769	781	791	1,069	1,081	1,099	1,261	1,323	1,335	1,416	1,348
96"	672	683	694	806	817	828	1,141	1,156	1,173	1,357	1,398	1,445	1,491	1,484
102"	697	709	719	843	853	865	1,213	1,231	1,247	1,453	1,473	1,554	1,566	1,620

VOLTA BATTERY CHARGER — 42

*PLEASE NOTE- EACH VOLTA LOW VOLTAGE SHADE INCLUDES POWER SUPPLY.

Volta™ QUIET BATTERY & LOW VOLTAGE VISION SHADES*

MOTORS INCLUDED IN SUGGESTED PRICING.

ALL VISION SHADES COME WITH MEDIUM CASSETTES AND LARGE CASSETTES WHEN NEEDED.

	24"	30"	36"	42"	48"	54"	60"	66"	72"	78"	84"	90"	96"	108"
36"	612	624	636	688	700	710	850	860	872	884	1,010	1,023	1,076	998
48"	638	650	660	726	736	748	922	932	944	954	1,085	1,122	1,148	1,072
60"	663	675	685	763	773	785	993	1,004	1,019	1,089	1,187	1,211	1,232	1,189
72"	688	700	710	800	810	822	1,064	1,076	1,094	1,225	1,289	1,301	1,315	1,306
84"	714	724	736	836	848	858	1,136	1,148	1,166	1,299	1,363	1,375	1,458	1,388
96"	739	750	761	873	884	895	1,208	1,282	1,299	1,398	1,440	1,488	1,536	1,529
102"	764	776	786	910	920	932	1,280	1,415	1,431	1,497	1,517	1,601	1,613	1,669

*PLEASE NOTE- EACH VOLTA LOW VOLTAGE SHADE INCLUDES POWER SUPPLY.

Volta™ MOTORIZATION CONTROLS

						
1 CHANNEL REMOTE \$104	15 CHANNEL REMOTE \$122	5 CHANNEL WALL SWITCH* \$94	1 CHANNEL WALL SWITCH \$80	2 CHANNEL WALL SWITCH \$90	15 CHANNEL WALL SWITCH \$98	SUN SENSOR \$66

ALL WALL SWITCHES INCLUDE A DECO-STYLE PLATE COVER.

VISION MILAN, SICILY, SORRENTO, TUSCANY
PG-4

VISION CHAIN OPERATED SHADES

ALL VISION SHADES COME WITH MEDIUM CASSETTES AND LARGE CASSETTES WHEN NEEDED.

	24"	30"	36"	42"	48"	54"	60"	66"	72"	78"	84"	90"	96"	108"
36"	258	268	280	344	356	366	538	550	560	572	586	598	650	574
48"	288	300	310	390	402	412	628	640	650	662	676	714	740	664
60"	320	330	342	436	446	458	718	730	740	754	766	816	830	754
72"	350	362	372	482	492	504	808	818	838	848	910	924	936	860
84"	382	394	404	528	538	550	898	908	928	938	1,000	1,014	1,026	960
96"	414	424	436	574	584	596	988	998	1,016	1,028	1,090	1,104	1,124	1,048
102"	444	456	466	620	630	642	1,078	1,096	1,110	1,168	1,188	1,200	1,214	1,266

	30"	36"	42"	48"	54"	60"	66"	72"	78"	84"	90"	96"	108"
VOLTA 110V STD. MOTOR	409	414	418	423	427	430	432	436	440	445	447	449	458
VOLTA 110V QUIET MOTOR	605	609	614	616	618	623	627	632	634	636	640	645	649
SOMFY 110V QUIET MOTOR	733	735	737	738	740	742	743	745	747	748	750	752	835
CELTIC II 110V MOTOR	392	396	400	405	409	412	414	418	423	427	430	432	440

All Motors Use Radio Receivers and Controls.

SOMFY LI-ION BATTERY MOTORIZATION— 400 SOMFY LI-ION BATTERY CHARGER — 60 SOMFY ST30 24V. MOTORIZATION— 730
CELTIC RECHARGEABLE BATTERY MOTORIZATION— 328 CELTIC BATTERY CHARGER — 60 **SOMFY & CELTIC MOTOR CONTROLS ON PAGE 47.**

Volta™ STANDARD BATTERY & LOW VOLTAGE VISION SHADES*

MOTORS INCLUDED IN SUGGESTED PRICING.

ALL VISION SHADES COME WITH MEDIUM CASSETTES AND LARGE CASSETTES WHEN NEEDED.

	24"	30"	36"	42"	48"	54"	60"	66"	72"	78"	84"	90"	96"	108"
36"	495	579	591	655	667	677	849	861	871	883	1,047	1,059	1,111	1,035
48"	599	611	621	701	713	723	939	951	961	973	1,137	1,175	1,201	1,125
60"	630	642	652	747	758	769	1,029	1,040	1,055	1,141	1,254	1,280	1,299	1,257
72"	661	673	683	793	803	815	1,119	1,129	1,149	1,309	1,371	1,385	1,397	1,388
84"	693	705	715	839	849	861	1,209	1,219	1,239	1,399	1,461	1,475	1,554	1,488
96"	724	736	746	885	895	907	1,299	1,313	1,330	1,514	1,555	1,602	1,648	1,641
102"	755	767	777	931	941	953	1,389	1,407	1,421	1,629	1,649	1,728	1,742	1,794

VOLTA BATTERY CHARGER — 42

*PLEASE NOTE- EACH VOLTA LOW VOLTAGE SHADE INCLUDES POWER SUPPLY.

Volta™ QUIET BATTERY & LOW VOLTAGE VISION SHADES*



MOTORS INCLUDED IN SUGGESTED PRICING.

ALL VISION SHADES COME WITH MEDIUM CASSETTES AND LARGE CASSETTES WHEN NEEDED.

	24"	30"	36"	42"	48"	54"	60"	66"	72"	78"	84"	90"	96"	108"
36"	636	646	658	722	734	744	916	928	938	950	1,078	1,091	1,144	1,066
48"	666	678	688	768	780	790	1,006	1,018	1,028	1,040	1,171	1,210	1,237	1,159
60"	697	709	719	814	825	836	1,096	1,107	1,122	1,194	1,292	1,318	1,338	1,294
72"	728	740	750	860	870	882	1,186	1,196	1,216	1,348	1,412	1,427	1,439	1,430
84"	760	772	782	906	916	928	1,276	1,286	1,306	1,441	1,505	1,519	1,601	1,533
96"	791	803	813	952	962	974	1,366	1,439	1,456	1,559	1,602	1,650	1,697	1,690
102"	822	834	844	998	1,008	1,020	1,456	1,591	1,605	1,678	1,698	1,780	1,794	1,848

*PLEASE NOTE- EACH VOLTA LOW VOLTAGE SHADE INCLUDES POWER SUPPLY.

Volta™ MOTORIZATION CONTROLS

						
1 CHANNEL REMOTE \$104	15 CHANNEL REMOTE \$122	5 CHANNEL WALL SWITCH* \$94	1 CHANNEL WALL SWITCH \$80	2 CHANNEL WALL SWITCH \$90	15 CHANNEL WALL SWITCH \$98	SUN SENSOR \$66

ALL WALL SWITCHES INCLUDE A DECO-STYLE PLATE COVER.

VISION
PG-5
NAPLES, ROMA, SIENA FR

VISION CHAIN OPERATED SHADES

ALL VISION SHADES COME WITH MEDIUM CASSETTES AND LARGE CASSETTES WHEN NEEDED.

	24"	30"	36"	42"	48"	54"	60"	66"	72"	78"	84"	90"	96"	108"
36"	334	346	356	460	472	482	770	782	792	804	818	830	882	806
48"	386	398	408	538	548	560	924	934	946	956	972	1,008	1,034	960
60"	440	450	462	616	626	638	1,076	1,088	1,098	1,114	1,124	1,174	1,188	1,112
72"	492	502	514	692	704	714	1,230	1,240	1,260	1,270	1,332	1,344	1,358	1,282
84"	544	554	566	770	782	792	1,382	1,394	1,412	1,424	1,486	1,498	1,512	1,444
96"	596	608	618	848	858	870	1,536	1,546	1,566	1,576	1,638	1,652	1,672	1,598
102"	648	660	670	926	936	948	1,688	1,708	1,722	1,778	1,800	1,812	1,826	1,878

	30"	36"	42"	48"	54"	60"	66"	72"	78"	84"	90"	96"	108"
VOLTA 110V STD. MOTOR	409	414	418	423	427	430	432	436	440	445	447	449	458
VOLTA 110V QUIET MOTOR	605	609	614	616	618	623	627	632	634	636	640	645	649
SOMFY 110V QUIET MOTOR	733	735	737	738	740	742	743	745	747	748	750	752	835
CELTIC II 110V MOTOR	392	396	400	405	409	412	414	418	423	427	430	432	440

All Motors Use Radio Receivers and Controls.

SOMFY LI-ION BATTERY MOTORIZATION— 400 SOMFY LI-ION BATTERY CHARGER — 60 SOMFY ST30 24V. MOTORIZATION— 730
 CELTIC RECHARGEABLE BATTERY MOTORIZATION— 328 CELTIC BATTERY CHARGER — 60 SOMFY & CELTIC MOTOR CONTROLS ON PAGE 47.

Volta™ STANDARD BATTERY & LOW VOLTAGE VISION SHADES*

MOTORS INCLUDED IN SUGGESTED PRICING.

ALL VISION SHADES COME WITH MEDIUM CASSETTES AND LARGE CASSETTES WHEN NEEDED.

	24"	30"	36"	42"	48"	54"	60"	66"	72"	78"	84"	90"	96"	108"
36"	571	657	667	771	783	793	1,081	1,093	1,103	1,115	1,279	1,291	1,343	1,267
48"	697	709	719	849	859	871	1,235	1,245	1,257	1,267	1,433	1,469	1,495	1,421
60"	750	761	772	926	937	948	1,388	1,398	1,414	1,499	1,613	1,637	1,657	1,616
72"	803	813	825	1,003	1,015	1,025	1,541	1,551	1,571	1,731	1,793	1,805	1,819	1,810
84"	855	865	877	1,081	1,093	1,103	1,693	1,705	1,723	1,885	1,947	1,959	2,040	1,972
96"	907	918	929	1,159	1,170	1,181	1,846	1,862	1,878	2,062	2,104	2,150	2,197	2,189
102"	959	971	981	1,237	1,247	1,259	1,999	2,019	2,033	2,239	2,261	2,340	2,354	2,406

VOLTA BATTERY CHARGER — 42

*PLEASE NOTE- EACH VOLTA LOW VOLTAGE SHADE INCLUDES POWER SUPPLY.

Volta™ QUIET BATTERY & LOW VOLTAGE VISION SHADES*





MOTORS INCLUDED IN SUGGESTED PRICING.

ALL VISION SHADES COME WITH MEDIUM CASSETTES AND LARGE CASSETTES WHEN NEEDED.

	24"	30"	36"	42"	48"	54"	60"	66"	72"	78"	84"	90"	96"	108"
36"	712	724	734	838	850	860	1,148	1,160	1,170	1,182	1,317	1,330	1,383	1,305
48"	764	776	786	916	926	938	1,302	1,312	1,324	1,334	1,476	1,513	1,540	1,464
60"	817	828	839	993	1,004	1,015	1,455	1,465	1,481	1,558	1,661	1,686	1,707	1,664
72"	870	880	892	1,070	1,082	1,092	1,608	1,618	1,638	1,783	1,847	1,859	1,874	1,864
84"	922	932	944	1,148	1,160	1,170	1,760	1,772	1,790	1,942	2,005	2,018	2,101	2,031
96"	974	985	996	1,226	1,237	1,248	1,913	1,988	2,004	2,124	2,167	2,214	2,263	2,255
102"	1,026	1,038	1,048	1,304	1,314	1,326	2,066	2,203	2,217	2,306	2,329	2,410	2,425	2,478

*PLEASE NOTE- EACH VOLTA LOW VOLTAGE SHADE INCLUDES POWER SUPPLY.

Volta™ MOTORIZATION CONTROLS

						
1 CHANNEL REMOTE \$104	15 CHANNEL REMOTE \$122	5 CHANNEL WALL SWITCH* \$94	1 CHANNEL WALL SWITCH \$80	2 CHANNEL WALL SWITCH \$90	15 CHANNEL WALL SWITCH \$98	SUN SENSOR \$66

ALL WALL SWITCHES INCLUDE A DECO-STYLE PLATE COVER.

VISAGE
PG-1

KNIGHTSBRIDGE- MAXIMUM WIDTH- 102". MAXIMUM LENGTH- 114"

VISAGE MANUALLY OPERATED SHADES

	24"	30"	36"	42"	48"	54"	60"	66"	72"	78"	84"	90"	96"	102"
36"	372	386	400	414	427	441	629	643	657	671	684	698	712	725
48"	415	429	442	456	470	483	713	727	741	754	768	782	796	809
60"	457	471	485	498	512	526	797	811	825	838	852	866	880	893
72"	500	513	527	541	555	568	881	895	909	922	936	950	963	977
84"	542	556	570	583	597	611	965	979	992	1,006	1,020	1,034	1,047	1,061
96"	585	598	612	626	639	653	1,049	1,063	1,076	1,090	1,104	1,118	1,131	1,145
108"	627	641	654	668	682	696	1,133	1,147	1,160	1,174	1,188	1,201	1,215	1,229
114"	648	662	676	689	703	717	1,175	1,189	1,202	1,216	1,230	1,243	1,257	1,271

LOW VOLTAGE SURCHARGES

SOMFY LI-ION BATTERY MOTORIZATION- 400
SOMFY LI-ION BATTERY CHARGER - 60
SOMFY ST30 24V. MOTORIZATION- 730
CELTIC RECHARGEABLE BATTERY MOTORIZATION- 328
CELTIC BATTERY CHARGER - 60

SOMFY & CELTIC MOTOR CONTROLS
ON PAGE 47 OF THE SOLARÉ PRICE LIST

MOTORS AND INTERNAL LITHIUM ION BATTERY INCLUDED
IN SUGGESTED PRICING.

Visage & Volta™ STANDARD BATTERY & NON BATTERY LOW VOLTAGE SHADES*

	24"	30"	36"	42"	48"	54"	60"	66"	72"	78"	84"	90"	96"	102"
36"	591	599	608	616	706	715	898	906	915	925	944	953	1,158	1,168
48"	632	641	649	739	748	756	981	989	1,000	1,008	1,027	1,036	1,241	1,251
60"	674	682	772	780	789	798	1,064	1,074	1,083	1,101	1,110	1,313	1,324	1,334
72"	715	805	813	822	830	839	1,147	1,157	1,175	1,184	1,385	1,396	1,407	1,417
84"	757	846	855	863	872	881	1,230	1,240	1,258	1,267	1,468	1,479	1,490	1,500
96"	879	888	896	905	913	922	1,314	1,323	1,341	1,350	1,551	1,562	1,571	1,582
108"	921	929	938	946	955	963	1,397	1,415	1,424	1,623	1,633	1,643	1,654	1,665
114"	942	950	959	967	976	984	1,439	1,456	1,465	1,663	1,674	1,685	1,696	1,706

VOLTA BATTERY CHARGER - 42

*PLEASE NOTE- EACH VOLTA NON BATTERY LOW VOLTAGE SHADE INCLUDES 110V. TRANSFORMER POWER SUPPLY.

MOTORS AND INTERNAL LITHIUM ION BATTERY INCLUDED
IN SUGGESTED PRICING.

Visage & Volta™ QUIET BATTERY & NON BATTERY LOW VOLTAGE SHADES*

	24"	30"	36"	42"	48"	54"	60"	66"	72"	78"	84"	90"	96"	102"
36"	751	760	769	778	787	796	980	989	998	1,007	1,015	1,024	1,169	1,180
48"	793	802	811	820	829	838	1,063	1,072	1,081	1,089	1,098	1,107	1,252	1,263
60"	834	843	852	861	870	879	1,146	1,155	1,164	1,172	1,181	1,325	1,335	1,346
72"	876	885	894	903	912	921	1,229	1,238	1,247	1,255	1,397	1,408	1,418	1,429
84"	917	926	935	944	953	962	1,312	1,321	1,329	1,338	1,480	1,491	1,501	1,512
96"	959	968	977	986	995	1,004	1,395	1,404	1,412	1,421	1,563	1,574	1,583	1,594
108"	1,000	1,009	1,018	1,027	1,036	1,045	1,478	1,486	1,495	1,635	1,644	1,655	1,666	1,677
114"	1,021	1,030	1,039	1,048	1,057	1,066	1,519	1,528	1,539	1,675	1,686	1,696	1,707	1,718

VOLTA BATTERY CHARGER - 42

*PLEASE NOTE- EACH VOLTA NON BATTERY LOW VOLTAGE SHADE INCLUDES 110V. TRANSFORMER POWER SUPPLY.

VISAGE
PG-2

KENSINGTON- MAXIMUM WIDTH- 102". MAXIMUM LENGTH- 156"

VISAGE MANUALLY OPERATED SHADES

	24"	30"	36"	42"	48"	54"	60"	66"	72"	78"	84"	90"	96"	102"
36"	395	408	422	436	450	463	674	688	701	715	729	743	756	770
48"	443	456	470	484	498	511	769	783	796	810	824	838	851	865
60"	491	504	518	532	546	559	864	878	892	905	919	933	946	960
72"	539	552	566	580	594	607	959	973	987	1,000	1,014	1,028	1,042	1,055
84"	587	600	614	628	642	655	1,054	1,068	1,082	1,095	1,109	1,123	1,137	1,150
96"	635	648	662	676	690	703	1,149	1,163	1,177	1,190	1,204	1,218	1,232	1,245
108"	683	696	710	724	738	751	1,244	1,258	1,272	1,286	1,299	1,313	1,327	1,340
120"	731	744	758	772	786	799	1,339	1,353	1,367	1,381	1,394	1,408	1,422	1,436
132"	779	792	806	820	834	847	1,435	1,448	1,462	1,476	1,489	1,503	1,517	1,531
144"	827	840	854	868	882	895	1,530	1,543	1,557	1,571	1,585	1,598	1,612	1,626
156"	875	889	902	916	930	943	1,625	1,638	1,652	1,666	1,680	1,693	1,707	1,721

LOW VOLTAGE SURCHARGES

SOMFY LI-ION BATTERY MOTORIZATION- 400
SOMFY LI-ION BATTERY CHARGER - 60
SOMFY ST30 24V. MOTORIZATION- 730
CELTIC RECHARGEABLE BATTERY MOTORIZATION- 328
CELTIC BATTERY CHARGER - 60

SOMFY & CELTIC MOTOR CONTROLS
ON PAGE 47 OF THE SOLARÉ PRICE LIST

OVERSIZED FREIGHT: ANY PRODUCT OVER 90" WIDE IS SUBJECT TO AN OVERSIZED SURCHARGE. SHIPMENTS WITHIN TRADING AREA WILL BE CHARGED \$95 & OUTSIDE TRADING AREA \$125. TRADING AREA INCLUDES TX, LA, NM, OK, MS, TN, AR. SHIPMENTS OVER 12' WILL BE CHARGED AN ADDITIONAL \$100, OVER 15'. ADDITIONAL SURCHARGES MAY APPLY FOR RESIDENTIAL SHIP LOCATIONS. SEE TEXTON FREIGHT POLICIES AT WWW.TEXTON.COM/FREIGHT_POLICY.

VISAGE
PG-2

KENSINGTON (CONTINUED)- MAXIMUM WIDTH- 102". MAXIMUM LENGTH- 156"

Visage & Volta™ STANDARD BATTERY & NON BATTERY LOW VOLTAGE SHADES*

MOTORS AND INTERNAL LITHIUM ION BATTERY INCLUDED
IN SUGGESTED PRICING.

	24"	30"	36"	42"	48"	54"	60"	66"	72"	78"	84"	90"	96"	102"
36"	613	622	630	639	728	737	942	951	959	970	988	997	1,202	1,213
48"	660	669	677	767	775	784	1,036	1,045	1,055	1,064	1,083	1,091	1,296	1,307
60"	707	716	805	814	822	831	1,131	1,141	1,150	1,168	1,177	1,380	1,391	1,401
72"	754	844	852	861	870	878	1,225	1,235	1,253	1,262	1,463	1,474	1,485	1,495
84"	801	891	899	908	917	925	1,319	1,329	1,347	1,356	1,557	1,568	1,579	1,590
96"	929	938	947	955	964	972	1,415	1,423	1,441	1,450	1,652	1,662	1,671	1,682
108"	977	985	994	1,002	1,011	1,019	1,509	1,526	1,535	1,735	1,744	1,755	1,766	1,776
120"	1,024	1,032	1,041	1,049	1,058	1,066	1,603	1,620	1,629	1,828	1,838	1,849	1,860	1,870
132"	1,071	1,079	1,088	1,096	1,105	1,113	1,697	1,715	1,911	1,922	1,932	1,943	1,954	2,083
144"	1,118	1,126	1,135	1,143	1,152	1,162	1,791	1,994	2,005	2,016	2,027	2,037	2,048	2,177
156"	1,165	1,173	1,182	1,190	1,199	1,209	2,078	2,089	2,099	2,110	2,121	2,131	2,142	2,271

VOLTA BATTERY CHARGER - 42

*PLEASE NOTE- EACH VOLTA NON BATTERY LOW
VOLTAGE SHADE INCLUDES 110V. TRANSFORMER
POWER SUPPLY.

Visage & Volta™ QUIET BATTERY & NON BATTERY LOW VOLTAGE SHADES*

MOTORS AND INTERNAL LITHIUM ION BATTERY INCLUDED
IN SUGGESTED PRICING.

	24"	30"	36"	42"	48"	54"	60"	66"	72"	78"	84"	90"	96"	102"
36"	774	783	792	801	810	818	1,024	1,033	1,042	1,051	1,060	1,069	1,214	1,225
48"	821	830	839	848	857	866	1,118	1,127	1,136	1,145	1,154	1,163	1,308	1,319
60"	868	877	886	895	904	913	1,213	1,222	1,230	1,239	1,248	1,392	1,402	1,413
72"	915	924	933	942	951	960	1,307	1,316	1,325	1,334	1,475	1,486	1,496	1,507
84"	962	971	980	989	998	1,007	1,401	1,410	1,419	1,428	1,569	1,580	1,591	1,601
96"	1,009	1,018	1,027	1,036	1,045	1,054	1,495	1,504	1,513	1,522	1,663	1,674	1,683	1,694
108"	1,056	1,065	1,074	1,083	1,092	1,101	1,589	1,598	1,607	1,746	1,756	1,767	1,777	1,788
120"	1,103	1,112	1,121	1,130	1,139	1,148	1,685	1,694	1,703	1,839	1,850	1,861	1,871	1,882
132"	1,150	1,159	1,170	1,179	1,188	1,197	1,780	1,789	1,922	1,933	1,944	1,955	2,033	2,097
144"	1,200	1,209	1,218	1,226	1,235	1,244	1,874	2,006	2,017	2,027	2,038	2,114	2,127	2,191
156"	1,247	1,256	1,265	1,274	1,282	1,291	2,089	2,100	2,111	2,121	2,195	2,208	2,221	2,271

VOLTA BATTERY CHARGER - 42

*PLEASE NOTE- EACH VOLTA NON BATTERY LOW
VOLTAGE SHADE INCLUDES 110V. TRANSFORMER
POWER SUPPLY.

VISAGE
PG-3

PIMLICO- MAXIMUM WIDTH- 102". MAXIMUM LENGTH- 130"

VISAGE MANUALLY OPERATED SHADES

	24"	30"	36"	42"	48"	54"	60"	66"	72"	78"	84"	90"	96"	102"
36"	422	436	449	463	477	491	728	742	756	770	783	797	811	825
48"	477	490	504	518	532	545	837	851	865	878	892	906	920	933
60"	532	545	559	573	586	600	946	960	973	987	1,001	1,014	1,028	1,042
72"	586	600	614	628	641	655	1,055	1,068	1,082	1,096	1,109	1,123	1,137	1,151
84"	641	655	669	682	696	710	1,163	1,177	1,191	1,204	1,218	1,232	1,246	1,259
96"	696	710	723	737	751	765	1,272	1,286	1,299	1,313	1,327	1,341	1,354	1,368
108"	751	765	778	792	806	819	1,381	1,394	1,408	1,422	1,436	1,449	1,463	1,477
120"	806	819	833	847	861	874	1,489	1,503	1,517	1,531	1,544	1,558	1,572	1,585
130"	861	874	888	902	915	929	1,598	1,612	1,626	1,639	1,653	1,667	1,680	1,694

LOW VOLTAGE SURCHARGES

SOMFY LI-ION BATTERY MOTORIZATION- 400
SOMFY LI-ION BATTERY CHARGER - 60
SOMFY ST30 24V. MOTORIZATION- 730
CELTIC RECHARGEABLE BATTERY MOTORIZATION- 328
CELTIC BATTERY CHARGER - 60

SOMFY & CELTIC MOTOR CONTROLS
ON PAGE 47 OF THE SOLARÉ PRICE LIST

Visage & Volta™ STANDARD BATTERY & NON BATTERY LOW VOLTAGE SHADES*

MOTORS AND INTERNAL LITHIUM ION BATTERY INCLUDED
IN SUGGESTED PRICING.

	24"	30"	36"	42"	48"	54"	60"	66"	72"	78"	84"	90"	96"	102"
36"	640	649	657	666	756	764	997	1,005	1,014	1,025	1,043	1,052	1,257	1,268
48"	694	703	711	801	809	818	1,105	1,113	1,124	1,132	1,151	1,160	1,365	1,375
60"	748	757	846	855	863	872	1,212	1,223	1,231	1,249	1,258	1,462	1,472	1,483
72"	802	892	900	909	917	926	1,320	1,330	1,348	1,357	1,559	1,569	1,580	1,591
84"	856	945	954	963	971	980	1,428	1,438	1,456	1,465	1,666	1,677	1,688	1,699
96"	991	999	1,008	1,016	1,025	1,034	1,537	1,546	1,564	1,573	1,774	1,785	1,794	1,805
108"	1,045	1,053	1,062	1,070	1,079	1,087	1,645	1,663	1,672	1,871	1,880	1,891	1,902	1,913
120"	1,099	1,107	1,116	1,124	1,133	1,141	1,753	1,770	1,779	1,977	1,988	1,999	2,010	2,020
130"	1,152	1,161	1,170	1,178	1,187	1,195	1,860	1,878	2,074	2,085	2,096	2,107	2,117	2,246

VOLTA BATTERY CHARGER - 42

*PLEASE NOTE- EACH VOLTA NON BATTERY LOW
VOLTAGE SHADE INCLUDES 110V. TRANSFORMER
POWER SUPPLY.

VISAGE
PG-3

PIMLICO (CONTINUED)- MAXIMUM WIDTH- 102". MAXIMUM LENGTH- 130"

Visage & Volta™ QUIET BATTERY & NON BATTERY LOW VOLTAGE SHADES*

MOTORS AND INTERNAL LITHIUM ION BATTERY INCLUDED
IN SUGGESTED PRICING.

	24"	30"	36"	42"	48"	54"	60"	66"	72"	78"	84"	90"	96"	102"
36"	801	810	819	828	837	846	1,079	1,088	1,097	1,106	1,115	1,124	1,269	1,279
48"	855	864	873	882	891	900	1,187	1,196	1,204	1,213	1,222	1,231	1,376	1,387
60"	909	918	927	936	945	953	1,294	1,303	1,312	1,321	1,330	1,473	1,484	1,495
72"	963	972	981	989	998	1,007	1,402	1,411	1,420	1,429	1,570	1,581	1,592	1,603
84"	1,017	1,025	1,034	1,043	1,052	1,061	1,510	1,519	1,528	1,537	1,678	1,689	1,700	1,710
96"	1,070	1,079	1,088	1,097	1,106	1,115	1,618	1,627	1,635	1,644	1,786	1,797	1,806	1,817
108"	1,124	1,133	1,142	1,151	1,160	1,169	1,725	1,734	1,743	1,883	1,892	1,903	1,914	1,924
120"	1,178	1,187	1,196	1,205	1,214	1,223	1,835	1,844	1,853	1,989	2,000	2,011	2,021	2,032
130"	1,232	1,241	1,252	1,261	1,270	1,279	1,943	1,952	2,086	2,097	2,107	2,118	2,196	2,260

VOLTA BATTERY CHARGER - 42

*PLEASE NOTE- EACH VOLTA NON BATTERY LOW VOLTAGE SHADE INCLUDES 110V. TRANSFORMER POWER SUPPLY.

VISAGE
PG-4

MAYFAIR- MAXIMUM WIDTH- 102". MAXIMUM LENGTH- 112"

VISAGE MANUALLY OPERATED SHADES

	24"	30"	36"	42"	48"	54"	60"	66"	72"	78"	84"	90"	96"	102"
36"	444	458	472	485	499	513	773	787	800	814	828	842	855	869
48"	505	518	532	546	559	573	893	907	920	934	948	961	975	989
60"	565	579	592	606	620	634	1,013	1,026	1,040	1,054	1,068	1,081	1,095	1,109
72"	625	639	653	667	680	694	1,133	1,146	1,160	1,174	1,187	1,201	1,215	1,229
84"	686	699	713	727	741	754	1,252	1,266	1,280	1,294	1,307	1,321	1,335	1,348
96"	746	760	774	787	801	815	1,372	1,386	1,400	1,413	1,427	1,441	1,455	1,468
108"	807	820	834	848	861	875	1,492	1,506	1,519	1,533	1,547	1,561	1,574	1,588
112"	837	850	864	878	892	905	1,552	1,566	1,579	1,593	1,607	1,621	1,634	1,648

LOW VOLTAGE SURCHARGES

SOMFY LI-ION BATTERY MOTORIZATION- 400
SOMFY LI-ION BATTERY CHARGER - 60
SOMFY ST30 24V. MOTORIZATION- 730
CELTIC RECHARGEABLE BATTERY MOTORIZATION- 328
CELTIC BATTERY CHARGER - 60

SOMFY & CELTIC MOTOR CONTROLS
ON PAGE 47 OF THE SOLARÉ PRICE LIST

Visage & Volta™ STANDARD BATTERY & NON BATTERY LOW VOLTAGE SHADES*

MOTORS AND INTERNAL LITHIUM ION BATTERY INCLUDED
IN SUGGESTED PRICING.

	24"	30"	36"	42"	48"	54"	60"	66"	72"	78"	84"	90"	96"	102"
36"	663	671	680	688	778	786	1,041	1,050	1,058	1,069	1,087	1,096	1,301	1,312
48"	722	731	739	829	837	846	1,160	1,169	1,179	1,188	1,206	1,215	1,420	1,431
60"	781	790	880	888	897	905	1,279	1,289	1,298	1,316	1,325	1,528	1,539	1,550
72"	841	931	939	948	956	965	1,398	1,408	1,426	1,435	1,637	1,647	1,658	1,669
84"	900	990	999	1,007	1,016	1,024	1,517	1,527	1,545	1,554	1,756	1,766	1,777	1,788
96"	1,041	1,049	1,058	1,067	1,075	1,084	1,637	1,646	1,664	1,673	1,874	1,885	1,894	1,905
108"	1,100	1,109	1,117	1,126	1,135	1,143	1,756	1,774	1,783	1,983	1,992	2,003	2,013	2,024
112"	1,130	1,139	1,147	1,156	1,164	1,173	1,816	1,833	1,842	2,041	2,051	2,062	2,073	2,083

VOLTA BATTERY CHARGER - 42

*PLEASE NOTE- EACH VOLTA NON BATTERY LOW VOLTAGE SHADE INCLUDES 110V. TRANSFORMER POWER SUPPLY.

Visage & Volta™ QUIET BATTERY & NON BATTERY LOW VOLTAGE SHADES*

MOTORS AND INTERNAL LITHIUM ION BATTERY INCLUDED
IN SUGGESTED PRICING.

	24"	30"	36"	42"	48"	54"	60"	66"	72"	78"	84"	90"	96"	102"
36"	823	832	841	850	859	868	1,123	1,132	1,141	1,150	1,159	1,168	1,313	1,324
48"	883	892	901	910	919	927	1,242	1,251	1,260	1,269	1,278	1,287	1,432	1,443
60"	942	951	960	969	978	987	1,361	1,370	1,379	1,388	1,397	1,540	1,551	1,562
72"	1,002	1,011	1,020	1,028	1,037	1,046	1,480	1,489	1,498	1,507	1,648	1,659	1,670	1,681
84"	1,061	1,070	1,079	1,088	1,097	1,106	1,599	1,608	1,617	1,626	1,767	1,778	1,789	1,800
96"	1,121	1,129	1,138	1,147	1,156	1,165	1,718	1,727	1,736	1,745	1,886	1,897	1,906	1,917
108"	1,180	1,189	1,198	1,207	1,216	1,225	1,837	1,846	1,855	1,994	2,003	2,014	2,025	2,036
112"	1,210	1,219	1,228	1,237	1,245	1,254	1,896	1,905	1,916	2,052	2,063	2,074	2,084	2,095

VOLTA BATTERY CHARGER - 42

*PLEASE NOTE- EACH VOLTA NON BATTERY LOW VOLTAGE SHADE INCLUDES 110V. TRANSFORMER POWER SUPPLY.

OVERSIZED FREIGHT: ANY PRODUCT OVER 90" WIDE IS SUBJECT TO AN OVERSIZED SURCHARGE. SHIPMENTS WITHIN TRADING AREA WILL BE CHARGED \$95 & OUTSIDE TRADING AREA \$125. TRADING AREA INCLUDES TX, LA, NM, OK, MS, TN, AR. SHIPMENTS OVER 12' WILL BE CHARGED AN ADDITIONAL \$100, OVER 15'. ADDITIONAL SURCHARGES MAY APPLY FOR RESIDENTIAL SHIP LOCATIONS. SEE TEXTON FREIGHT POLICIES AT WWW.TEXTON.COM/FREIGHT_POLICY.

STANDARD ROLLER SHADE SPECIFICATIONS

SIZE STANDARDS

STANDARD FABRIC ORIENTATION

MINIMUM WIDTH	8"
MAXIMUM WIDTH	SEE PAGES 3-6.
MAXIMUM HEIGHT	180"

RAILROADED (MATERIAL TURNED) SHADES SIZE STANDARDS

MINIMUM WIDTH	8"
MAXIMUM WIDTH	144"
MAXIMUM HEIGHT	FABRIC WIDTH MINUS 18"

FACTORY DEDUCTIONS

1 1/4" THROUGH 2" TUBE

IB OR OB FABRIC WIDTH	MINUS 1 1/8"
IB OR OB BRACKET TO BRACKET WIDTH	ORDERED WIDTH
FABRIC WIDTH	ORDERED WIDTH
OB FABRIC WIDTH	MINUS 7/8"
CLOTH HEADRAIL WIDTH	MINUS 7/8"
CLOTH FABRIC WIDTH	ORDERED WIDTH
CLOTH WIDTH BRACKET TO BRACKET WIDTH	ADD 1 1/8"
110V MOTORIZED	MINUS 1 5/8"

2 1/2" (GALAXY SYSTEM) TUBE

IB OR OB FABRIC WIDTH	MINUS 1 3/8"
IB OR OB BRACKET TO BRACKET WIDTH	ORDERED WIDTH
FABRIC WIDTH	ORDERED WIDTH
OB FABRIC WIDTH	MINUS 7/8"
CLOTH HEADRAIL WIDTH	MINUS 7/8"
CLOTH FABRIC WIDTH	ORDERED WIDTH
CLOTH WIDTH BRACKET TO BRACKET WIDTH	ADD 1 3/8"
110V MOTORIZED	MINUS 2"

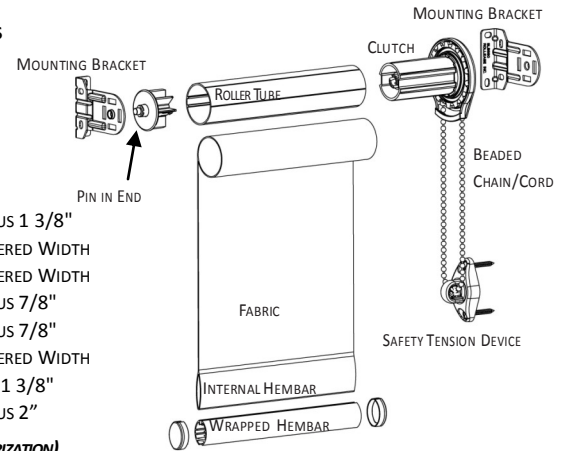

SEE PAGE 46 FOR TUBE SIZES, MOUNTING REQUIREMENTS & SIZE LIMITATIONS (INCLUDING MOTORIZATION).

ROLLER SHADES WITH 4" FASCIA SPECIFICATIONS

SIZE STANDARDS

STANDARD FABRIC ORIENTATION

MINIMUM WIDTH	8"
MAXIMUM WIDTH	SEE PAGES 3-6.
MAXIMUM HEIGHT	180"

RAILROADED (MATERIAL TURNED) SHADES SIZE STANDARDS

MINIMUM WIDTH	8"
MAXIMUM WIDTH	144"
MAXIMUM HEIGHT	FABRIC WIDTH MINUS 18"

FACTORY DEDUCTIONS

1 1/4" THROUGH 2" TUBE

IB OR OB FABRIC WIDTH	MINUS 1 1/8"
IB OR OB BRACKET TO BRACKET WIDTH	ORDERED WIDTH
FABRIC WIDTH	ORDERED WIDTH
OB FABRIC WIDTH	MINUS 7/8"
CLOTH HEADRAIL WIDTH	MINUS 7/8"
CLOTH FABRIC WIDTH	ORDERED WIDTH
CLOTH WIDTH BRACKET TO BRACKET WIDTH	ADD 1 1/8"
110V MOTORIZED	MINUS 1 5/8"

IB OR OB FABRIC WIDTH	MINUS 1 3/8"
IB OR OB BRACKET TO BRACKET WIDTH	ORDERED WIDTH
FABRIC WIDTH	ORDERED WIDTH
OB FABRIC WIDTH	MINUS 7/8"
CLOTH HEADRAIL WIDTH	MINUS 7/8"
CLOTH FABRIC WIDTH	ORDERED WIDTH
CLOTH WIDTH BRACKET TO BRACKET WIDTH	ADD 1 3/8"
110V MOTORIZED	MINUS 2 1/4"

2 1/2" (GALAXY SYSTEM) TUBE

IB OR OB FABRIC WIDTH	MINUS 1 3/8"
IB OR OB BRACKET TO BRACKET WIDTH	ORDERED WIDTH
FABRIC WIDTH	ORDERED WIDTH
OB FABRIC WIDTH	MINUS 7/8"
CLOTH HEADRAIL WIDTH	MINUS 7/8"
CLOTH FABRIC WIDTH	ORDERED WIDTH
CLOTH WIDTH BRACKET TO BRACKET WIDTH	ADD 1 3/8"
110V MOTORIZED	MINUS 2 1/4"

IB OR OB FABRIC WIDTH	MINUS 1 3/8"
IB OR OB BRACKET TO BRACKET WIDTH	ORDERED WIDTH
FABRIC WIDTH	ORDERED WIDTH
OB FABRIC WIDTH	MINUS 7/8"
CLOTH HEADRAIL WIDTH	MINUS 7/8"
CLOTH FABRIC WIDTH	ORDERED WIDTH
CLOTH WIDTH BRACKET TO BRACKET WIDTH	ADD 1 3/8"
110V MOTORIZED	MINUS 2 1/4"

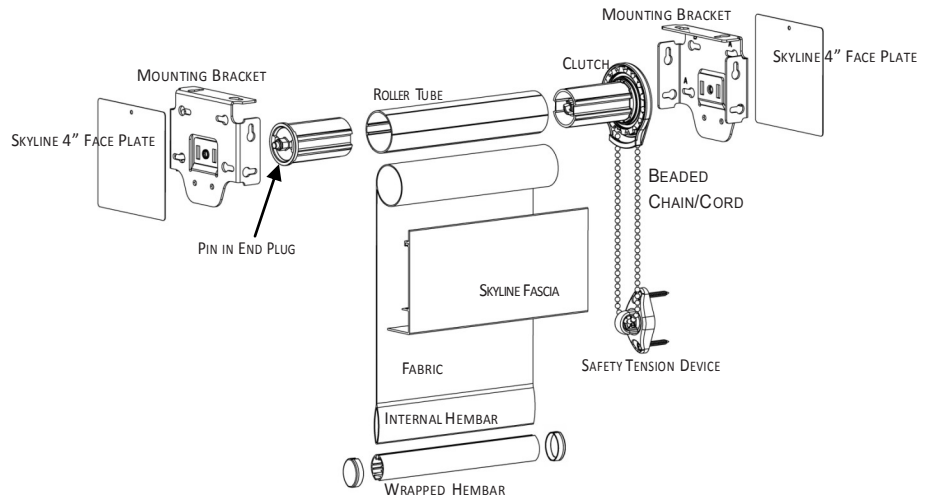

SEE PAGE 46 FOR TUBE SIZES, MOUNTING REQUIREMENTS & SIZE LIMITATIONS (INCLUDING MOTORIZATION).

ROLLER SHADES WITH 5" FASCIA SPECIFICATIONS

SIZE STANDARDS

STANDARD FABRIC ORIENTATION

MINIMUM WIDTH	8"
MAXIMUM WIDTH	SEE PAGES 3-6.
MAXIMUM HEIGHT	180"

RAILROADED (MATERIAL TURNED) SHADES SIZE STANDARDS

Minimum Width	8"
Maximum Width	144"
Maximum Height	Fabric Width Minus 18"

FACTORY DEDUCTIONS

1 1/4" THROUGH 2" TUBE

IB OR OB FABRIC WIDTH	MINUS 1 1/8"
IB OR OB BRACKET TO BRACKET WIDTH	ORDERED WIDTH
FABRIC WIDTH	ORDERED WIDTH
OB FABRIC WIDTH	MINUS 7/8"
CLOTH HEADRAIL WIDTH	MINUS 7/8"
CLOTH FABRIC WIDTH	ORDERED WIDTH
CLOTH WIDTH BRACKET TO BRACKET WIDTH	ADD 1 1/8"
110V MOTORIZED	MINUS 1 9/16"

IB OR OB FABRIC WIDTH	MINUS 1 3/8"
IB OR OB BRACKET TO BRACKET WIDTH	ORDERED WIDTH
FABRIC WIDTH	ORDERED WIDTH
OB FABRIC WIDTH	MINUS 7/8"
CLOTH HEADRAIL WIDTH	MINUS 7/8"
CLOTH FABRIC WIDTH	ORDERED WIDTH
CLOTH WIDTH BRACKET TO BRACKET WIDTH	ADD 1 3/8"
110V MOTORIZED	MINUS 1 11/16"

2 1/2" (GALAXY SYSTEM) TUBE

IB OR OB FABRIC WIDTH	MINUS 1 3/8"
IB OR OB BRACKET TO BRACKET WIDTH	ORDERED WIDTH
FABRIC WIDTH	ORDERED WIDTH
OB FABRIC WIDTH	MINUS 7/8"
CLOTH HEADRAIL WIDTH	MINUS 7/8"
CLOTH FABRIC WIDTH	ORDERED WIDTH
CLOTH WIDTH BRACKET TO BRACKET WIDTH	ADD 1 3/8"
110V MOTORIZED	MINUS 1 11/16"

IB OR OB FABRIC WIDTH	MINUS 1 3/8"
IB OR OB BRACKET TO BRACKET WIDTH	ORDERED WIDTH
FABRIC WIDTH	ORDERED WIDTH
OB FABRIC WIDTH	MINUS 7/8"
CLOTH HEADRAIL WIDTH	MINUS 7/8"
CLOTH FABRIC WIDTH	ORDERED WIDTH
CLOTH WIDTH BRACKET TO BRACKET WIDTH	ADD 1 3/8"
110V MOTORIZED	MINUS 1 11/16"

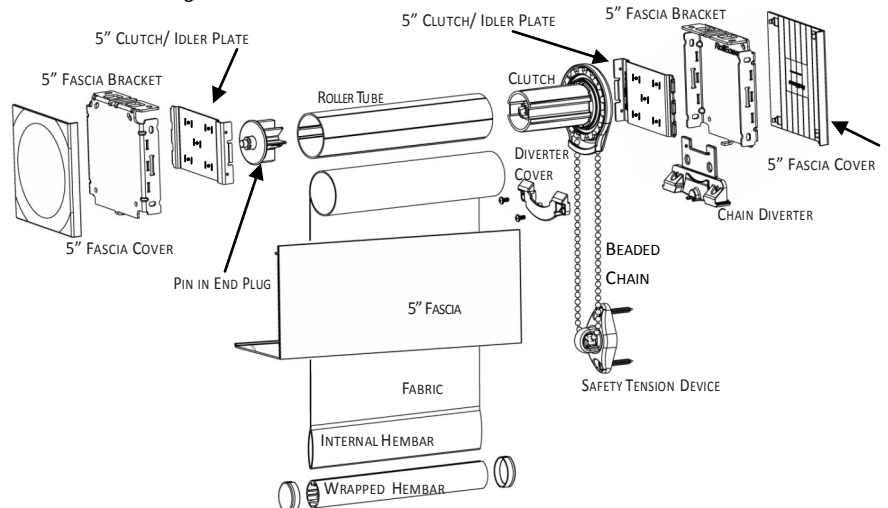

SEE PAGE 46 FOR TUBE SIZES, MOUNTING REQUIREMENTS & SIZE LIMITATIONS (INCLUDING MOTORIZATION).

MANUAL ROLLER SHADES & NEOLUX TRANSITIONAL SHADES WITH CASSETTE SPECIFICATIONS MEDIUM (100) & LARGE (120)

SIZE STANDARDS

STANDARD FABRIC ORIENTATION

MINIMUM WIDTH	8"
MAXIMUM WIDTH	SEE PAGES 3-6.
MAXIMUM HEIGHT	120" *

RAILOADED (MATERIAL TURNED) SHADES SIZE STANDARDS

MINIMUM WIDTH	8"
MAXIMUM WIDTH	144"
MAXIMUM HEIGHT	FABRIC WIDTH MINUS 18"

FACTORY DEDUCTIONS

1 1/4" THROUGH 2" TUBE

IB OR OB FABRIC WIDTH	MINUS 1 1/8"
IB OR OB BRACKET TO BRACKET WIDTH	ORDERED WIDTH
FABRIC WIDTH	ORDERED WIDTH
OB FABRIC WIDTH	MINUS 7/8"
CLOTH HEADRAIL WIDTH	MINUS 7/8"
CLOTH FABRIC WIDTH	ORDERED WIDTH
CLOTH WIDTH BRACKET TO BRACKET WIDTH	ADD 1 1/8"
110V MOTORIZED	MINUS 1 1/4"

2 1/2" (GALAXY SYSTEM) TUBE

IB OR OB FABRIC WIDTH	MINUS 1 3/8"
IB OR OB BRACKET TO BRACKET WIDTH	ORDERED WIDTH
FABRIC WIDTH	ORDERED WIDTH
OB FABRIC WIDTH	MINUS 7/8"
CLOTH HEADRAIL WIDTH	MINUS 7/8"
CLOTH FABRIC WIDTH	ORDERED WIDTH
CLOTH WIDTH BRACKET TO BRACKET WIDTH	ADD 1 3/8"
110V MOTORIZED	N/A

SEE PAGE 46 FOR TUBE SIZES, MOUNTING REQUIREMENTS & SIZE LIMITATIONS (INCLUDING MOTORIZATION).

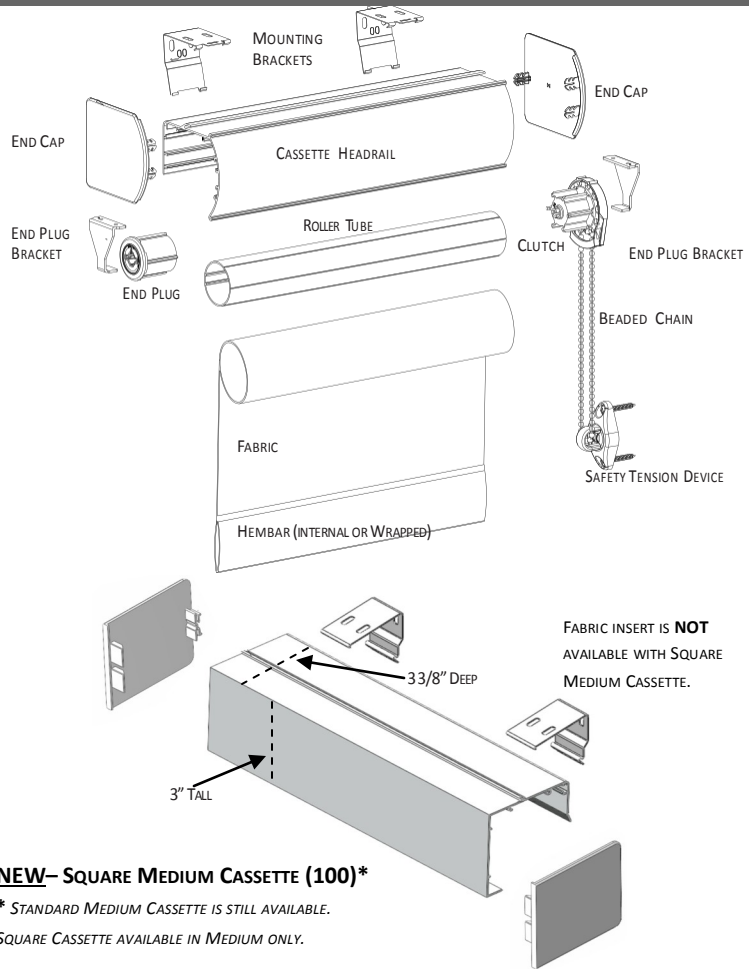

NEW- SQUARE MEDIUM CASSETTE (100)*

* STANDARD MEDIUM CASSETTE IS STILL AVAILABLE.
SQUARE CASSETTE AVAILABLE IN MEDIUM ONLY.

CORDLESS MANUAL ROLLER SHADE SPECIFICATIONS

SIZE STANDARDS

STANDARD FABRIC ORIENTATION

MINIMUM WIDTH	18"
MINIMUM WIDTH WITH CASSETTE	19"
MAXIMUM WIDTH	96"
MAXIMUM HEIGHT	96"

FACTORY DEDUCTIONS

CORDLESS MEDIUM & LARGE CASSETTE

IB HEADRAIL WIDTH	MINUS 1/8"
IB FABRIC WIDTH	MINUS 1"
OB HEADRAIL WIDTH	EXACT
OB FABRIC WIDTH	MINUS 7/8"
CLOTH HEADRAIL WIDTH	PLUS 7/8"
CLOTH FABRIC WIDTH	ORDERED WIDTH

1 1/4" THROUGH 2" TUBE

IB HEADRAIL WIDTH	MINUS 1/8"
IB FABRIC WIDTH	MINUS 1 1/8"
OB HEADRAIL WIDTH	ORDERED WIDTH
OB FABRIC WIDTH	MINUS 7/8"
CLOTH HEADRAIL WIDTH	PLUS 7/8"
CLOTH FABRIC WIDTH	ORDERED WIDTH

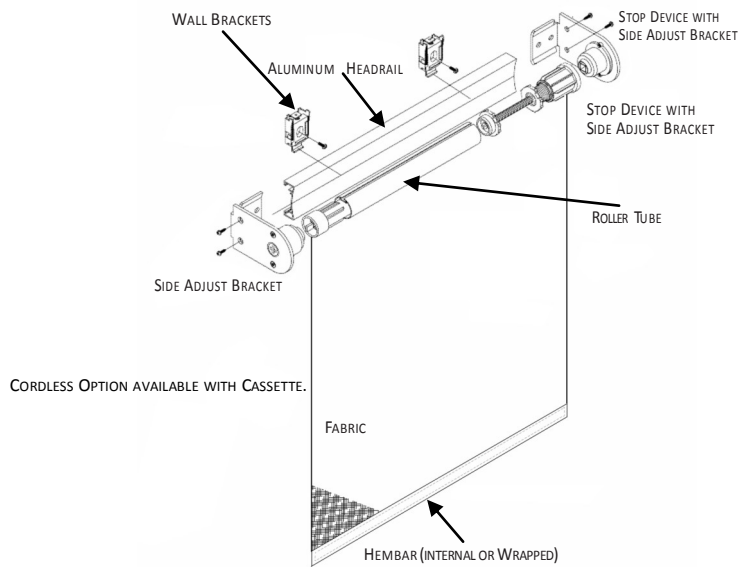

SEE PAGE 46 FOR TUBE SIZES, MOUNTING REQUIREMENTS & SIZE LIMITATIONS (INCLUDING MOTORIZATION).

TUBE SIZES, MOUNTING REQUIREMENTS & SIZE LIMITATIONS

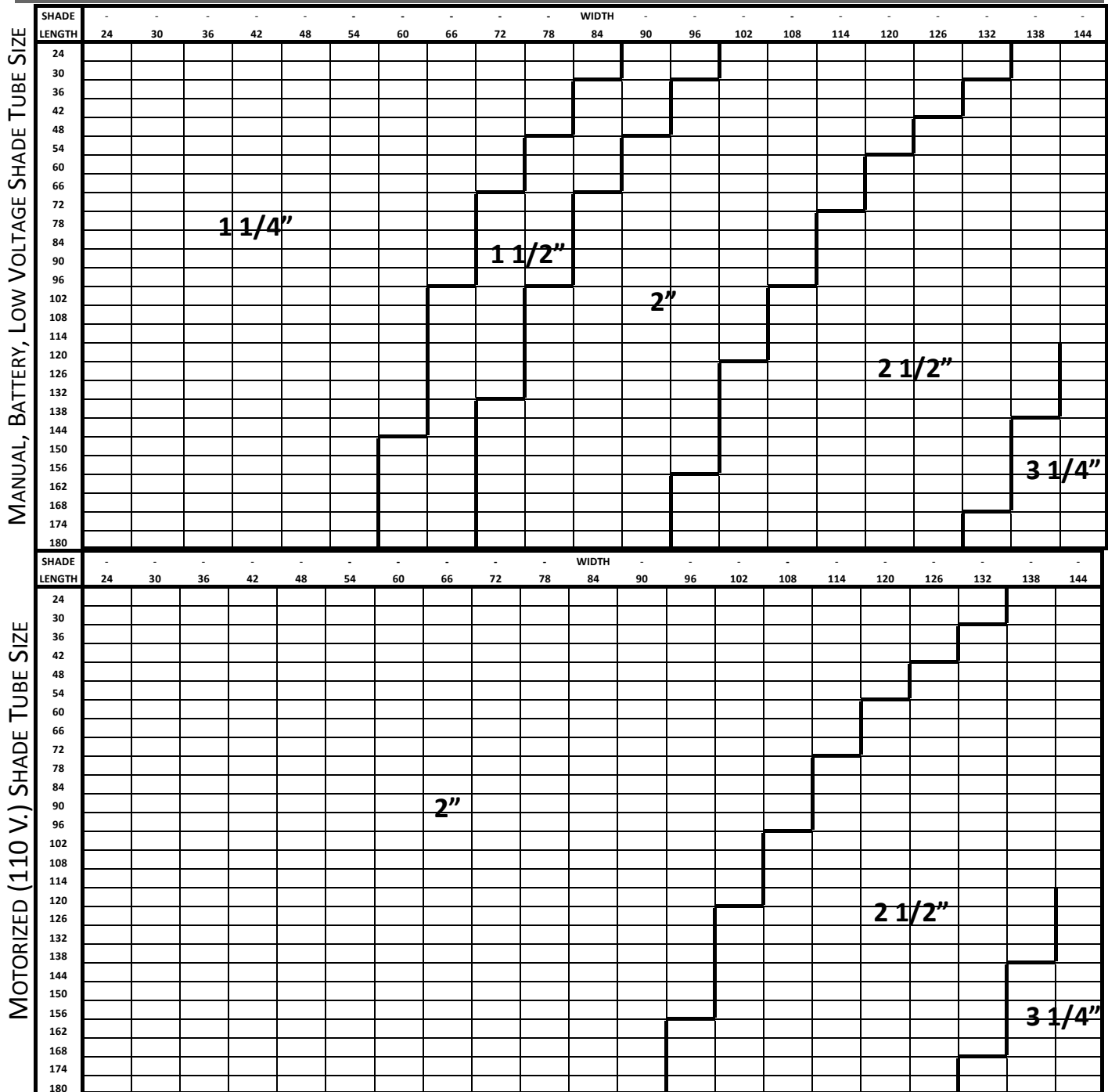

GENERAL SIZE LIMITATIONS

	MIN WIDTH	MAX WIDTH	MAX LENGTH
MANUAL INTERIOR SHADES	8"	156"	192"
MAGIC TOUCH CORDLESS SHADE	20"	90"	90"
MEDIUM CASSETTE	12"	96"	96"
LARGE CASSETTE	12"	108"	120"
4" FASCIA	12"	144"	Varies
5" FASCIA	12"	156"	180"
SOMFY 110V. RTS MOTOR	25"	168"+	192"+
SOMFY 24V. MOTOR	20"	96"	96"
SOMFY BATTERY MOTOR	16"	96"	96"
CELTIC II 110V. RADIO MOTOR	27"	168"+	192"+
CELTIC II BATTERY RADIO MOTOR	24"	84"+	84"
VOLTA STANDARD BATTERY	22"	168"	168"
VOLTA QUIET BATTERY	30"	168"	168"
VOLTA STANDARD LOW VOLTAGE	16"	168"	168"
VOLTA QUIET LOW VOLTAGE	22"	168"	168"
VOLTA STANDARD 110V. MOTOR	29"	168"+	192"+
VOLTA QUIET 110V. MOTOR	28"	168"+	192"+

MINIMUM MOUNTING REQUIREMENTS FOR INSIDE MOUNT (IB) & FLUSH MOUNT

	IB Manual	Flush	IB 110V.	Flush
4" Fascia	1"	4"	1"	4"
Without Fascia	5/8"	2 1/2"*	5/8"	2 1/2"*
Small Cassette	2 1/4"	2 3/4"	N/A	N/A
Large Cassette	2 1/4"	4"	2 1/4"	4"
5" Fascia	1"	5"	1"	5"
Cordless	2"	2 1/2"*	N/A	N/A

* May vary on larger Shades.

MOTORIZATION CONTROL PRICING



SOMFY RTS CONTROLS

NAME	DESCRIPTION	COLOR OPTION	PRICE
TELIS 1	1 CHANNEL REMOTE	PURE*	125
TELIS 4	5 CHANNEL REMOTE	PURE*	161
TELIS 16	16 CHANNEL REMOTE	PURE*	514
DECOFLEX 1	1 CHANNEL WALL SWITCH	WHITE OR IVORY*	290
DECOFLEX 5	5 CHANNEL WALL SWITCH	WHITE OR IVORY*	304
SMOOVE	1 CHANNEL WALL SWITCH	PURE*	144
URTSI 16 CHANNEL REPEATER	16 CHANNEL SMART HOME INTERFACE	WHITE	920
MYLINK TRANSFORMER	REMOTE USING TABLE/CELL PHONE TECHNOLOGY	WHITE (PLUG-IN ADAPTOR)	438
TRANSFORMER	12 VOLT PLUG-IN TRANSFORMER (1)	WHITE	242
TRANSFORMER	24V PLUG-IN TRANSFORMER (1)	WHITE	101
TRANSFORMER	24V DC 20 AMP TABLE TOP TRANSFORMER (6)	BLACK	784
TRANSFORMER	24V DC 20 AMP TABLE TOP TRANSFORMER (9)	BLACK	973
TRANSFORMER	24V DC 20 AMP TABLE TOP TRANSFORMER (12)	BLACK	2,278

CELTIC II RADIO CONTROLS

NAME/ DESCRIPTION	COLOR OPTION	PRICE
ONE CHANNEL REMOTE	WHITE	50
SIX CHANNEL REMOTE	WHITE	66
SIXTEEN CHANNEL REMOTE	WHITE	78
ANTENNA RS232	WHITE	480
WIRELESS 1 CHANNEL WALL SWITCH	WHITE	100
WIRELESS 6 CHANNEL WALL SWITCH	WHITE	120
BATTERY CHARGER (ADDITIONAL FOR BATTERY)	WHITE	60

*OTHER COLOR OPTIONS MAY BE AVAILABLE.

CONTACT TEXTON FOR ADDITIONAL CONTROL & ACCESSORIES

GENERAL MOTORIZATION INFORMATION

INTERIOR 110V. & 24V. MOTORIZED SHADES USE SONESSE QUIETTECHNOLOGY.

SOLARÉ MOTORIZED SHADES PROVIDE THE IDEAL SOLUTION FOR INACCESSIBLE HIGH WINDOWS, EXTERIOR PATIOS EXECUTIVE SPACES, INTELLIGENT HOMES, AND MANY PUBLIC AREAS. FROM THE BOARDROOM TO THE BEDROOM, SOLARÉ MOTORIZED SHADES CAN MEET YOUR CLIENT'S CRITERIA. VISIT TEXTON.COM FOR MORE IN-DEPTH INFORMATION REGARDING MOTOR SPECIFICATIONS, WIRING DIAGRAMS, PROGRAMMING INSTRUCTIONS, AND MUCH MORE.



RADIO TECHNOLOGY SOMFY (RTS) OPERATES ON RADIO FREQUENCY CONTROL. RTS ALLOWS FOR:

- EASY INSTALLATION & PROGRAMMING—NO WIRING FROM THE CONTROL UNIT TO THE MOTOR.
- ROBUST CONTROL DISTANCE OF 65 FEET.
- UPGRADEABLE. AS YOUR NEEDS CHANGE, YOU CAN ADD NEW CONTROLS AND AUTOMATIC FEATURES OR

SOMFY BATTERY SOLAR PANEL

THE WIREFREE SOLAR PACK TAKES ADVANTAGE OF RENEWABLE SOLAR ENERGY IN ORDER TO POWER YOUR WIRE-FREE (BATTERY) MOTORIZED WINDOW COVERINGS. THIS LATEST INNOVATION FROM SOMFY SHEDS NEW LIGHT ON WIRE-FREE MOTORIZED SHADES, BY OFFERING THE FOLLOWING FEATURES:

- PATENTED ENERGY SAVING TECHNOLOGY USES NATURAL SUNLIGHT TO POWER THE MOTORIZED SHADES.
- MAINTENANCE FREE SOLUTION THAT DOESN'T REQUIRE THE USE OF AN ELECTRICIAN.
- CONVENIENT AND COST EFFECTIVE— REDUCES BATTERY REPLACEMENT, AND PRESERVES THE ENVIRONMENT.
- EASY TO INSTALL FOR NEW AND EXISTING WINDOW COVERING INSTALLATIONS.
- LOW PROFILE SOLAR (PHOTOVOLTAIC) PANEL IS DISCREET AND EASY TO CONCEAL

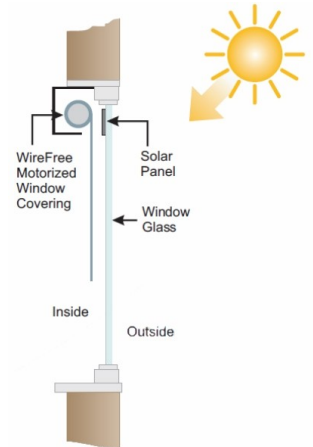

CHILD SAFETY

OUR SOLARÉ ROLLER SHADES ARE DESIGNED WITH CHILD SAFETY AS A PRIORITY. TO REDUCE THE RISK OF STRANGULATION, OUR FABRICATION METHODS INCORPORATE FEATURES TO COMPLY WITH THE CURRENT ANSI CORD SAFETY STANDARD. FABRICATION METHODS INCLUDE BREAKAWAY CORD STOPS, CORD-SHIELD CORDING, AND TENSION DEVICES.

TO FURTHER REDUCE THE RISK OF ACCIDENTS, ALL CORDS SHOULD BE KEPT OUT OF REACH OF CHILDREN. CORD CLEATS CAN HELP IMPLEMENT THIS ESSENTIAL PRECAUTION AND ARE THEREFORE INCLUDED WITH ALL STANDARD CORD LOCK/PULL CORD ROLLER SHADE PRODUCTS.

FOR SOLARÉ ROLLER SHADES MADE WITH A CLUTCH OPERATING SYSTEM OUR TENSION DEVICE IS DESIGNED AND IS TO BE PLACED AND SHIPPED SO THAT, UNLESS IT IS PROPERLY INSTALLED (OR ALTERED FROM THE SHIPPED CONDITION WITH SEQUENTIAL PROCESS OR TOOLS), THE TENSION DEVICE PREVENTS THE SHADE FROM OPERATING. THE TENSION DEVICE ONCE INSTALLED CAN HELP PREVENT CHILDREN FROM PULLING CORDS AROUND THEIR NECKS.



CORD TENSION DEVICE

CARE & CLEANING

ROLLER SHADE FABRICS ARE SPECIALLY TREATED TO REPEL DUST AND DIRT.

- **DUSTING:** REGULAR DUSTING MAINTAINS A LIKE-NEW APPEARANCE. **VACUUMING:** FOR DEEPER CLEANING, VACUUM GENTLY WITH A FURNITURE BRUSH ATTACHMENT OF ANY VACUUM CLEANER.
- **SPOT-CLEANING:** SPOT-CLEAN SHADES WITH SOFT CLOTH OR SPONGE MOISTENED WITH LUKEWARM WATER. ADD MILD DETERGENT IF NEEDED. BLOT GENTLY AND DRY SHADE IN FULLY LOWERED POSITION.

SOMFY MOTOR WARRANTY

SOMFY OFFERS A 5 YEAR WARRANTY ON ALL MOTORS AND CONTROLS. SPECIFICALLY, SOMFY WARRANTS ITS MOTORS AND CONTROLS TO BE FREE FROM DEFECTS IN MATERIAL AND WORKMANSHIP UNDER NORMAL AND PROPER USE FOR A PERIOD OF 5 YEARS COMMENCING WITH THE DATE STAMPED ON EACH PRODUCT. IF THE SOMFY PRODUCT FAILS WITHIN THIS 5 YEAR PERIOD, SOMFY WILL REPAIR OR REPLACE IT FREE OF CHARGE THROUGH YOUR END PRODUCT SUPPLIER. BATTERIES ARE NOT COVERED BY THIS WARRANTY.



Volta™ MOTOR WARRANTY

TEXTON & ROLLEAS ACMEDA WARRANTS ITS AC AND DC WIRED MOTORS AND ELECTRONIC ACCESSORIES TO BE FREE FROM DEFECTS IN MATERIALS AND WORKMANSHIP FOR 7 YEARS, AND WARRANTS BATTERY POWERED DC MOTORS TO BE FREE FROM DEFECTS IN MATERIALS AND WORKMANSHIP FOR 5 YEARS WHEN INSTALLED PROPERLY AND OPERATED UNDER NORMAL USE FROM THE DATE STAMPED OR AFFIXED LABEL ON EACH DEVICE.

IF A ROLLEAS ACMEDA MOTOR AND ELECTRONIC ACCESSORY IS FOUND TO BE DEFECTIVE AND COVERED BY THE WARRANTY, WE WILL, AT OUR OPTION, REPAIR OR REPLACE IT FREE OF CHARGE.

REPAIRS OR REPLACEMENTS WILL BE MADE WITH LIKE OR SIMILAR PARTS AND PRODUCTS, AND EXCLUDE THE COST OF REMOVAL AND REINSTALLATION. THIS PRODUCT WARRANTY DOES NOT COVER ANY CONDITIONS OR DAMAGES RESULTING FROM MISUSE OR ABUSE, ACCIDENTS, ALTERATIONS, NEGLIGENCE, DAMAGE BY OTHERS, NATURAL DISASTERS, EXPOSURE TO THE ELEMENTS, OR FAILURE TO FOLLOW ROLLEAS ACMEDA INSTRUCTIONS WITH RESPECT TO INSTALLATION, USE AND MAINTENANCE.

THE REPAIR OR REPLACEMENT OF DEFECTIVE PRODUCT IS THE PURCHASER'S SOLE REMEDY AND THE LIMIT OF ROLLEAS ACMEDA'S OBLIGATION. EXCEPT AS EXPRESSLY PROVIDED IN THIS PARAGRAPH, ROLLEAS ACMEDA MAKES NO REPRESENTATIONS OR WARRANTIES OF ANY KIND, NATURE OR DESCRIPTION, EXPRESSED OR IMPLIED, INCLUDING WITHOUT LIMITATION ANY WARRANTY OF MERCHANTABILITY OR FITNESS OF ANY PRODUCTS FOR ANY PARTICULAR PURPOSE, AND HEREBY DISCLAIMS THE SAME. IN NO EVENT SHALL ROLLEAS ACMEDA BE LIABLE OR RESPONSIBLE FOR INCIDENTAL OR CONSEQUENTIAL DAMAGES OR FOR ANY OTHER DIRECT OR INDIRECT DAMAGE, LOSS, COST, EXPENSE OR FEE.

TO RETURN PRODUCTS FOR INSPECTION AND, IF THE CONDITION OR DAMAGE IS COVERED BY THE WARRANTY, REPAIR OR REPLACEMENT, CONTACT US FOR A RETURN GOODS AUTHORIZATION (RGA) NUMBER, AND THEN SHIP THE PARTS IN QUESTION BACK TO ROLLEAS ACMEDA, FREIGHT CHARGES PRE-PAID. ROLLEAS ACMEDA WILL INSPECT AND REPAIR OR REPLACE ANY COVERED, DEFECTIVE ITEMS AND RETURN THEM FREIGHT PRE-PAID.

WARRANTY EXCLUSIONS:

- INSTALLATION AND USAGE ARE NOT IN ACCORDANCE WITH OUR INSTALLATION AND OPERATING INSTRUCTIONS.
- PRODUCT HAS BEEN OPENED, DISMANTLED OR RETURNED WITH CLEAR EVIDENCE OF ABUSE OR OTHER DAMAGE.
- PRODUCT HAS BEEN USED TO PERFORM FUNCTIONS OTHER THAN THE FUNCTIONS IT WAS DESIGNED TO HANDLE, NAMELY MOTORIZING WINDOW ATTACHMENTS (E.G., SHADES, ROLLING SHUTTERS, AND AWNINGS).
- PRODUCT IS USED WITH ELECTRICAL ACCESSORIES (SWITCHES, RELAYS, ETC.) THAT HAVE NOT BEEN PREVIOUSLY APPROVED IN WRITING BY THE ROLLEAS ACMEDA INNOVATION AND DESIGN CENTER.

LIMITED LIFETIME WARRANTY

TEXTON, INC. WARRANTS THAT SOLARÉ ROLLER SHADES WILL BE FREE FROM DEFECTS IN MATERIALS AND WORKMANSHIP FOR AS LONG AS THE ORIGINAL RETAIL PURCHASER OWNS THE PRODUCT, PROVIDED THAT PRODUCTS WERE PROPERLY INSTALLED IN RESIDENTIAL DWELLINGS AND PRODUCTS WERE MADE OR ASSEMBLED EXCLUSIVELY FROM SOLARÉ MATERIALS AND COMPONENTS.

THE OBLIGATION OF TEXTON, INC. IS LIMITED TO REPAIR OR REPLACE THE SHADINGS OR COMPONENTS FOUND TO BE DEFECTIVE, AND EXCLUDES SHIPPING CHARGES AND LABOR COSTS FOR MEASURING, FABRICATING AND INSTALLATION. REPAIRS WILL BE MADE WITH LIKE OR SIMILAR PARTS.

THIS WARRANTY DOES NOT INCLUDE ANY CONDITIONS OR DAMAGES RESULTING FROM ACCIDENTS, ALTERATIONS, EXPOSURE TO ELEMENTS (WHICH COULD CAUSE, AMONG OTHER THINGS, THE FADING OF SHADE COLORS), MISUSE, ABUSE, MOTORIZED DEVICES, OR FAILURE TO FOLLOW OUR INSTRUCTIONS WITH RESPECT TO MEASUREMENT, INSTALLATION, CLEANING OR MAINTENANCE. THIS WARRANTY DOES NOT COVER DAMAGE TO SHADE FABRICS AS A RESULT OF USING WINDOW CLEANERS OR SIMILAR SUBSTANCES, WHICH COULD CAUSE DISCOLORATION OF THE SHADES. THIS WARRANTY DOES NOT COVER ANY CONDITION OR DAMAGE RESULTING FROM REMOVAL OF THE SHADE AND REINSTALLATION IN THE SAME OR ANOTHER WINDOW.

THIS WARRANTY DOES NOT APPLY TO CONDITIONS CAUSED BY NORMAL WEAR AND TEAR UPON THE PRODUCT. THIS WARRANTY IS EXCLUSIVE AND IN LIEU OF ALL OTHER OBLIGATIONS, LIABILITIES OR WARRANTIES. IN NO EVENT SHALL TEXTON, INC. BE LIABLE OR RESPONSIBLE FOR INCIDENTAL OR CONSEQUENTIAL DAMAGES OR FOR ANY OTHER DIRECT OR INDIRECT DAMAGE, LOSS, COST, EXPENSE OR FEE. SOME STATES DO NOT ALLOW THE EXCLUSION OR LIMITATION OF INCIDENTAL OR CONSEQUENTIAL DAMAGES, SO THIS EXCLUSION OR LIMITATION MAY NOT APPLY TO YOU.



CELTIC MOTOR WARRANTY



TEXTON WARRANTS THEIR CELTIC II MOTORS TO BE UNDER THE STANDARDS OF CTUVUS FOR A PERIOD OF 5 YEARS FROM THEIR TIME OF DELIVERY. ALL MOTORS ARE GUARANTEED AGAINST ANY ABNORMAL DEGRADATION UNDER

NORMAL USE AND OPERATION INCLUDING USE IN CONJUNCTION WITH THE MOTORS ELECTRICAL RATINGS, INSTALLED ACCORDING TO TEXTON INSTRUCTIONS AND GUIDELINES, AND WEIGHT CAPACITIES AND LIMITS ARE NOT EXCEEDED BY SPECIFIC MOTOR.

EXCLUSIONS: THE WARRANTY DOES NOT APPLY TO INADEQUATE TRANSPORTATION AND/OR STORAGE, IMPROPER INSTALLATION, OPERATION WITH INADEQUATE ELECTRICAL INSTALLATION (INCLUDING POOR GROUND OR LACK OF PROTECTION AGAINST ELECTRICAL SURGES OR BROWN OUTS), INSTALLATION & OPERATION IN HUMID ENVIRONMENT, MODIFICATION OF ANY PART OF THE MOTOR WITH THE EXCEPTION OF MOTOR BRACKETS PROVIDED BY TEXTON, CUTTING THE CABLE, DRILLING INTO THE MOTOR, OR USING DRILL TO SET LIMITS.

TERMS AND CONDITIONS: EFFECTIVE WARRANTY FROM THE DELIVERY DATE AND CONDITIONAL UPON PROMPT AND TOTAL PAYMENT OF PRODUCT'S INVOICES. TEXTON WILL REPLACE AT ITS OWN DISCRETION WITHOUT CHARGE ANY PRODUCT RECOGNIZED AS DEFECTIVE BY TEXTON'S QUALITY CONTROL DEPARTMENT. SAID MOTORS MUST BE COMPLETELY AVAILABLE TO TEXTON FOR THE INSPECTION. IN CASE OF REPAIR, WARRANTY WILL BE ACTIVE FROM THE INITIAL DATE OF PURCHASE. WARRANTY DOES NOT COVER TRANSPORTATION EXPENSES, LABOR, AND INSTALLATION AND/OR REMOVAL OF THE REPLACEMENT. EVERY CLAIM MUST BE PRESENTED WITH THE PAID PURCHASE INVOICE, ADDRESSED NO LATER THAN 30 DAYS AFTER THE OBSERVATION OF THE DEFECT TO TEXTON.